

NEW TESTAMENT
HISTORY
THE CHRIST
AND THE
INTER-TESTAMENT
PERIOD

BIBLE STUDY TEXTBOOK SERIES

**NEW TESTAMENT
HISTORY
The Christ**

by

Wallace Wartick

**THE INTER-TESTAMENT
PERIOD**

by

William Smith — Revised

by Wilbur Fields

College Press, Joplin, Missouri

iii

Copyright 1972
COLLEGE PRESS

DEDICATION

To my wife: Wanda;
to my children:
Elaine, Duane, Dwight—
the ones who
sacrificed that
this book might
be possible.

ACKNOWLEDGEMENTS

We wish to express our thanks to the following for permission to quote from their publications.

American Bible Society.
Appleton-Century-Crofts.
Baker Book House.
Bethany Fellowship.
Bible-Science Association, Inc. (Box 1016, Caldwell, Idaho 83605).
Biblical Research Press.
College Press.
Concordia Publishing House.
Creation Research Society (by permission of the editor).
DeHoff Publications.
Doorway Papers.
Doubleday.
Wm. B. Eerdmans Publishing Company.
Evangelical Press and Service Ltd. (American agents: Puritan
Publication, Inc.)
Fortress Press (Muhlenberg Press).
Golden Press.
International Christian Crusade.
Inter-Varsity Press.
Harold Shaw Publishers.
Lockman Foundation, The.
Moody Press.
National Council of Churches.
New American Library (Signet).
Pacific Press Publishing Association.
Paternoster Press (Great Britain).
Pergamon Press Ltd.
Plain Truth, The.
Princeton University Press.
Putnam Press.
Reader's Digest.
St. Thomas Press.
Sentinel Publishing Company.
Standard Publishing.

CONTENTS

HARMONY OF MATTHEW, MARK, LUKE, JOHN

Places, Time Periods, Events, Scripture

<i>Pages</i>			<i>Matthew</i>	<i>Mark</i>	<i>Luke</i>	<i>John</i>
THE BEGINNING						
1, 297	1.	Prologue and introductions	1	1	1	1
5, 301	2. Jerusalem	— Gabriel's announcement to Zechariah about a son			1	
6, 303	3. Nazareth	— Mary and Gabriel			1	
7, 305	4. Judea	— Mary, Elizabeth, & Mary's "song."			1	
7, 303	5. Nazareth	— Joseph informed about Mary, their marriage	1			
8, 306	6. Judea	— Birth of John, Zechariah's prophetic utterance			1	
THIRTY YEARS PREPARATION						
10, 307	7. Bethlehem	— Birth of Jesus			2	
11, 309	8. Jerusalem	— Presented in the Temple			2	
12, 311	9. Bethlehem	— Wisemen found Him	2			
13, 312	10. Egypt	— leaving from Herod's decree	2			
15, 312	11. Nazareth	— Boyhood home	2			
15, 314	12. Jerusalem	— Passover, age 12			2	
17, 314	13. Nazareth	— Grew up until about 30 years old			2	
18, 315	14. Jordan in wilderness	of Judea — Immersed by John (Genealogy)	1, 3	1	3	
(323)			4	1	4	
20, 320	15. Wilderness	— Tempted by Satan				
24, 325	15. Bethany	— Pointed out by John, obtained first disciples (beyond Jordan)				1
26, 327	17. Cana of Galilee	— Wedding, first miracle				2
28, 328	18. Capernaum	— With family and disciples "Abode not many days"				2

FIRST YEAR OF MINISTRY

EARLY JUDEAN MINISTRY (8 or 9 months)

30, 328	19. Jerusalem	— FIRST PASSOVER; cleansed temple (First <i>public</i> ministry on record)			
30, 330	20. Judea	— Period of about 8 or 9 months Miracles ("no man can do these things. . . .") Preached to Nicodemus new birth and eternal life, Son lifted up Making and immersing more disciples than John			2 3
35, 334	21. Sychar in Samaria	— Woman at well; all city came out; abode two days (4 months to harvest)			4

III:

GALILEAN MINISTRY (1 year and 3 or 4 months)

38, 337	22. Cana of Galilee	— Spoke the word and the nobleman's son at Capernaum was healed			
39, 338	23. Nazareth	— Read and taught in synagogue; first rejection there			4
40, 340	24. Capernaum	— (1) Called four fishermen (2) Healed demoniac in synagogue (3) Peter's mother-in-law, crowd in the street	4	1 1	4 5 4
42, 343	25. First Galilean tour	— (1) Great crowds, miracles (2) Leper healed (3) Paralytic through roof (4) Call of Matthew, feast of publicans (5) Controversies over eating and fasting	8 4 8 9 9 9	1 1 2 2 2	4 4 5 5 5 5
			9	2	5

<i>Pages</i>				Matthew	Mark	Luke	John
SECOND YEAR OF MINISTRY							
47, 349	26. Jerusalem	—	SECOND PASSEVER: Lame man at pool; controversy about Sabbath healing; sermon on deity and credentials				5
50, 353	27. Galilee	—	(1) Controversy over Sabbath reaping	12	2	6	
			(2) Healed withered hand on Sabbath in synagogue (Capernaum?)	12	3	6	
			(3) Thronging crowds from far and near, many miracles	12	3	6	
			(4) Named twelve "Apostles"		3	6	
			(5) Sermon on the Mount	5, 6, 7		6	
			(6) Healed centurion's servant in Capernaum	8		7	
xi:	63, 370	28. Nain	—			7	
	64, 371	29. Capernaum	—			7	
			(1) Question from John the Baptist; sermon on John	11			
			(2) Condemnation of unrepentant cities; the great invitation	11			
			(3) In house of Simon the Pharisee; Penitent woman forgiven			7	
	68, 375	30. Second Galilean Tour	—				
			(1) Healed blind and dumb demoniac; charge of league with Satan	12	3		
			(2) Sign sought; Sign of Jonah; Judgment of this generation	12			
			(3) Mother and brethren try to interrupt	12	3	8	
			(4) Sermon in parables	13	4	8	
			(5) Challenge of high cost to would-be followers	8		9	
	77, 383	31. On Sea of Galilee	—	8	4	8	
	78, 384	32. Gergesa	—	8	5	8	
			Demoniacs and swine				

<i>Pages</i>			Matthew	Mark	Luke	John
79, 387	33. Capernaum	— Healed woman with flow of blood, Raised Jairus' daughter	9	5	8	
		— Healed two blind men and dumb demoniac	9			
81, 391	34. Nazareth	— Apparently last visit; unbelief; some miracles	13	6		
81, 392	35. Third Galilean tour	— Twelve sent out in pairs;	10	6	9	
		— Herod's fear of Jesus (Tour ends at Capernaum, multitudes greatly aroused.)	14	6	9	
85, 396	36. Across the Sea, near Bethsaida Julias	— THIRD PASSOVER NIGH—Day of teaching; fed 5,000; refused crown; night of prayer	14	6	9	6

x

THIRD YEAR OF MINISTRY

RETIREMENTS AND TRAVELS WITH THE TWELVE (6 month)

88, 398	37. On the Sea	— (In the night) Walked on water; stilled tempest	14	6		6
89, 400	38. Gennesaret	— Miracles	14	6		
89, 401	39. Capernaum	— Sermon on the Bread of Life — Many forsake Him; controversy with Pharisees about traditions (washing)	15	7		6
94, 406	40. Phoenicia	— Retirement with apostles; healed demonized daughter of Syro- Phoenician woman	15	7		
96, 407	41. Decapolis	— Healed deaf stammerer and man others	15	7		
		— Fed 4,000 (considerable public ministry implied)	15	8		

<i>Pages</i>			Matthew	Mark	Luke	John
97, 409	42. Magadan	— Pharisees and Sadducees demand sign from heaven	16	8		
97, 411	43. On the Sea	— Crossing in boat; warned disciples against influence of popular leaders and parties	16	8		
98, 411	44. Bethsaida	— Healing of blind man		8		
98, 412	45. Caesarea Philippi	— Question of Jesus' identity; Peter's confession	16	8	9	
		— First plain prediction of His death	16	8	9	
103, 414	46. An exceeding high mountain (Hermon?)	— Transfiguration	17	9	9	
		— Healed demoniac boy	17	9	9	
		— Further prediction of cross	17	9	9	
106, 419	47. Capernaum	— (1) Peter and the temple tax	17			
		(2) Discussion of who shall be greatest	18	9	9	
		(3) The unknown worker of miracles		9	9	
		(4) Discussion of stumbling blocks, mistreatment, forgiveness	18	9		
		(5) Advice of His unbelieving brethren				7
108, 425	48. Journey through Samaria	— Sons of Thunder would call down fire			9	

ix.

LATER JUDEAN MINISTRY (about 3 months)

109, 426	49. Jerusalem	— (1) FEAST OF TABERNACLES: Confused opinions about Him; Attempt to arrest Him; Water of Life				7
		(2) Sermon on the Light of the world; freedom; Abraham's Seed				8
		(3) Healing the man born blind; controversy				9
		(4) The Good Shepherd and the Door of the Sheep				10
		(5) The seventy sent out; discussion on their return				10

<i>Pages</i>		<i>Matthew</i>	<i>Mark</i>	<i>Luke</i>	<i>John</i>
	(6) A lawyer's question; parable of good Samaritan				
118, 438	50. Bethany — Jesus and Mary and Martha			10	
119, 439	51. Place of Prayer — Discourse on Prayer			10	
122, 440	52. Place Unknown — Controversy about demons and league with Satan			11	
	— Signe and judgment of this generation			11	
124, 443	53. Pharisee's house — Invited to dinner; Denounced Phariseeism			11	
125, 445	54. Before a multitude of many thousands			11	
	Great evangelistic appeals			12 & 13	
	(1) Warning against hypocrisy & fear of men				
	(2) Against covetousness: parable of rich fool				
	(3) Against anxiety for worldly needs: trust God				
	(4) Urged watchfulness and preparedness for day of account; parable of waiting servants and wise steward				
	(5) Christ the burning issue: no neutrality				
	(6) Settle with God "out of court"				
	(7) No difference, <i>all</i> must repent				
	(8) Parable of fig tree: 3 chances, one more, then cut down				
129, 449	55. In a synagogue — Woman bowed double; controversy about Sabbath healing			13	
	— Parables of the kingdom: mustard & leaven			13	
130, 450	56. Temple in Jerusalem — Feast of Dedication; Attempts to kill Jesus for blasphemy; Jesus' claims: the door, the good Shepherd, one with God, the Son of God				10
 <i>LATER PEREAN MINISTRY</i> (about 3 months) 					
132, 451	57. Perea — Retirement to place of His baptism				10
132, 451	58. Cities and villages — Journeys and discussions in Perea: few saved, Herod the fox			13	

<i>Pages</i>		Matthew	Mark	Luke	John
136, 454	59. Home of a Pharisee — On the Sabbath, healed dropsy and discussion; conduct at feasts: chief seats, whom to invite; parable of great feast, slighted invitation, excuses			14	
136, 455	60. Before a great multitude — Sermon on cost of discipleship			14	
137, 456	61. Place Unknown —				
	(1) Parables of lost sheep, coin & son			15	
	(2) Parable of the unjust steward			16	
	(3) The rich man and Lazarus			16	
	(4) Stumbling blocks; forgiveness; unprofitable servants			17	
142, 462	62. Bethany — Raising of Lazarus				11
	— Rulers in Jerusalem plot to kill Jesus				11
148, 466	63. Ephraim (city) — "Tarried" with the disciples				11
148, 466	64. Trip through borders of Samaria, Galilee, and Perea to Jerusalem			17	
	(1) Healing ten lepers				
	(2) Sermon on the time of the coming of the kingdom				
	(3) Teaching on prayer: the unjust judge; Pharisee & Publican			18	
	(4) Teaching on divorce (in Perea)	19	10		
	(5) Jesus and the little children	19	10	18	
	Rich young ruler; peril of riches				
	(6) Apostles' reward	19	10	18	
	(7) Parable of laborers in the vineyard	20			
	(8) Plain prediction of the crucifixion	20	10	18	
	(9) James and John ask chief honors	20	10		
166. 480	65. Jericho — Blind men healed (Bartimaeus)	20	10	18	

Pages

LAST WEEK IN JERUSALEM AREA

		Matthew	Mark	Luke	John
171, 483	67. Bethany				
174, 485	68. Jerusalem	26:6-13	14:3-9		12:1-11
177, 489	69. Bethany	21	11	19	12
178, 490	70. Jerusalem	21	11		
178, 490	71. Bethany	21	11	19	
179, 490	72. Jerusalem	21:17	11:19		
	— Reception: Mary anoints Jesus				
	— "Triumphal" entry (probably on Sunday)				
	— Next day cursed fig tree on the way to Jerusalem				
	— Second cleansing of the temple (Monday?)				
	— Night's lodging				
	— (Tuesday?) Day of discussions				
	(1) Question of Jesus' authority	21	11	20	
	(2) Parable of two sons	21			
	(3) Parable of the vineyard	21	12	20	
	(4) Parable of the wedding garment	22			
	(5) Question of tribute to Caesar	22	12	20	
	(6) Question of the resurrection	22	12	20	
	(7) Question of the greatest commandment	22	12		
	(8) Question about the Son of David	22	12	20	
	(9) Denunciation of Scribes and Pharisees	23	12	20	
	(10) Widow's mite		12	21	
	(11) Sermon on significance of life and death				
	(12) Predictions of end of Jerusalem and of the world; His second coming				12
	(13) On judgment: ten virgins; talents; judgment scene	24	13	21	
	(14) Prediction of Jesus' death	25			
	(Wednesday?) Judas' plot to betray Jesus	26	14	22	
		26	14	22	

ix.

184, 499

194, 510

<i>Pages</i>		<i>Matthew</i>	<i>Mark</i>	<i>Luke</i>	<i>John</i>
	FOURTH PASSOVER				
206, 527	(15) Thursday, first day of unleavened bread; made ready the Passover	26:17-19	14:12-16	22:7-13	
210, 529	(16) (The Upper Room) after night (Jewish Friday) Passover meal; feet washed; disciples warned; Judas departed; Lord's supper instituted; farewell discourse with the apostles	26	14	22	13 & 14
210, 542	(17) (Out in the night) Parting instructions and predictions: parable of the vine; Holy Spirit promised; Great intercessory prayer				15 & 16 17
230, 554	(18) (Gethsemane) Agony and prayer; angels came; betrayal and arrest	26	14	22	18
AX 233, 559	(19) (Court Rooms) Trials before Annas, Caiaphas, Sanhedrin, Pilate, Herod, Pilate; Tortures	26 & 27	14 & 15	22 & 23	18
245, 573	(20) (Golgotha) Crucifixion and burial (Friday, day of Preparation)	27	15	23	19
	FORTY DAYS AFTER THE RESURRECTION				
265, 582	(21) (In a garden outside the city) Sunday—the resurrection announced to women at the tomb	28	16	24	
	— Appearance to other women	28			
	— Appearance to Mary (22) (Jerusalem)		16:9		20
	— The women report to the apostles		16	24	20
	— The guards report to the chief priests	28			
	— Appearance to Peter	(I Cor. 15:5)		24:34	

<i>Pages</i>		<i>Matthew</i>	<i>Mark</i>	<i>Luke</i>	<i>John</i>
276, 587	73. Trip to Emmaus	— Appearance and teaching to two disciples	16	24	
279, 587	74. Jerusalem	— (same night) Appearance to the ten (8 days later) Appearance to the eleven (I Cor. 15:5)	16	24	20 20
284, 590	75. Galilee	— Appearance to seven by the sea — To the disciples on a mountain; Great commission — To more than 500 brethren (I Cor. 15:6)	28		21
293, 590	76. Jerusalem	— Appearance to James; to the apostles (I Cor. 15:7; Acts 1)			24
593	77. Near Bethany	— The ascension (Acts 1; Phil. 2; Eph. 1)		16	24

SELECTED STUDIES

LXX	595	<i>General Introduction to the Four Gospels</i>
	601	Matthew
	607	Mark
	611	Luke
	618	John
	626	Bibliography on Gospels
	629	<i>Interpretation of the Bible</i>
	634	<i>Leprosy, Some Facts and Fantasies</i>
	636	<i>Death, What is it?</i>
	641	<i>Quirinius and the Census</i>
	643	<i>Who or What is the Holy Spirit</i> (Seth Wilson) (Wallace Wartick)
	645	
	652	<i>Palestine, A Glimpse of the Climate</i>
	659	<i>Jewish Calendar</i>
	660	<i>The Christian and Evolution</i>

Pages

NEW TESTAMENT BACKGROUNDS

713	
715	The Persian Period
718	The Greek Period
724	The Ptolemies
745	The Maccabean Period
757	(map of Maccabean Palestine)
780	The Asmonean Kingdom
797	Herod the Great
829	The Herods, The Jews, and Rome
885	Special Studies on the Jews
967	Bibliography on <i>Selected Studies</i>
970	Chart on N.T. Canon
IIAX 4A	Map No. 1 on Life of Christ
30A	Map No. 2 on Life of Christ
46A	Map No. 3 on Life of Christ
88A	Map No. 4 on Life of Christ
109A	Map No. 5 on Life of Christ
132A	Map No. 6 on Life of Christ
171A	Map No. 7 on Life of Christ

PREFACE

The following book is intended to further the kingdom of God on earth. Perhaps in a world where books abound, both on the subject of Christ and other subjects, one more is hardly needed and will cause but little ripple. Yet, the present author finds a multiplication of books more helpful than not, and welcomes new ones, especially on Christ, His person and revelation. The editor of College Press, Don DeWelt, wanted a sequel to *Old Testament History* by Wilbur Fields. This is part of that sequel. If God is willing, the second part covering Acts through Revelation will be written and published sometime hence.

Thanks is to be extended to several who have encouraged and helped in the writing of this material. Judith Weeks, Karla Jordan and Cathy Jacobs helped type much of the manuscript and get it ready for the printer. Seth Wilson will see what he taught in class or in life often reflected in the pages that follow. Other teachers have likewise helped. Many men through their commentaries have stimulated ideas or thoughts that appear on the following pages. To some express credit is given. To others who over years of study have been utilized, I give thanks also. Many are listed in the bibliographies at the end of the book. If some thoughts are expressed and credit is not given, upon notice of such, we will be glad to correct the oversight. As for this book, if the reader can find it useful in any way, feel free to use it without any undue worry about giving the author "credit." God really gives the only credit that is worth mentioning, and He will adequately care for all of us. As Seth Wilson would say, "There is no end to the good you can do if you don't care who gets the credit."

INTRODUCTION

The procedure followed in the book is to give a running comment (henceforth referred to as "exposition") that in some ways can be read without extensive reference to the text. Each text to be considered is listed at the appropriate place. The harmony outline at the front of the section on the Gospels serves as a general guide to times, places and events. It is a modification of the outline that appeared in C. J. Sharp's *The Christ of the Four Gospels*, by Standard Publishing Co., 1942. R. C. Foster actually produced the original outline itself. It surely will be helpful if the reader will turn to the text(s) under consideration and study it before the comments are read. The section of notes and questions is likewise to be studied with text in hand. Some events that are placed together for study are not to be considered as having happened at the same times necessarily. An evidence of this would be the calling of the four fishermen. Other places are noted of similar nature.

The translations in the book are either from *The New American Standard* (abbreviated NAS), *The Revised Standard Version* (abbreviated RSV) or the author's own. Wilbur Fields, who wrote the section on the Inter-testament period, will make his own acknowledgements.

We suggest that the reader make a harmony for study. The section of notes/questions will list the text(s) under consideration, giving scriptural limitations. The use of two small New Testaments like those from American Bible Society at about thirty-five cents each will do nicely. The small New Testaments may be purchased in either the King James version, or the Revised Standard version. Some magic mending tape, a pair of scissors and about three hundred sheets of paper will also be needed. We advise those who write with the right hand to tape the text on the "back" side of the page (with the holes along the right side).

Thus, if the harmony is placed in a notebook, the right-hand page will always be open for notes, etc. The New Testaments are in small enough columns that where the incident is recorded in all four Gospels, they will still go on the average $8 \times 10\frac{1}{2}$ sheet of notebook paper. Some texts will be too long to get on one page, and two or three pages will be needed. Examples of such are the Sermon on the Mount, the parables in Matt. 13; John 5; etc.

The book is obviously limited in many respects. It was not intended for "scholars" as such, but more for the church member and/or beginning student of Jesus' life. The first section is to enable the reader to get a general grasp of the text. The notes/question section is intended to help textual study, and supply some detailed notes not thought appropriate in the first section. Much could have been written that was not (R. C. H. Lenski wrote some forty-five hundred pages on the Gospels, and did not say all that could be said.) because of the nature of the book. May what has been said be helpful to some. If such occurs, the labor will be well spent.

The expression "Synoptics" means Matthew, Mark and Luke, not John. The Greek term *synopsis* means "to see together." The Synoptics sometimes record the same event, prior to the events of the final week. John's Gospel seldom records the same event as the Synoptics until the last week.

The abbreviation "ca." means about or approximately, in regard to year or years. The abbreviation "ff." means the following verse or verses, page or pages. The expression "cf." means compare the text or idea with the one under discussion. The expression "i.e." means "that is," or in "other words." The abbreviation "MS" means (one) manuscript. The plural is "MSS." In pronunciation of Greek, ē sounds like the "a" in date, ō sounds like the "o" in boat, otherwise they are like short "e" and "o."

THE BEGINNING

"You are the Christ, the Son of the living God!" To this end were the four accounts of Matthew, Mark, Luke, and John written, that we might come to believe about Jesus, who He is. We can only say from our point in history that John's stated reason for writing, John 20:30, 31, was also the reason the other three accounts were written. Each has its place in God's plan to draw for the reader a clear portrait of His Son. These books are designed to present evidence which is sufficient to the reasoning mind to produce faith. For that cause, and for no other, did God have these books written. He did not intend to leave us without a basis for faith, so that we would believe blindly, irrationally, a "leap in the dark" sort-of-thing. He did not intend either, that a mark of unbelief would be a mark of intellectual incapacity. The Christian system was and is directed to rational, thinking human beings. Each of the Gospels, then, draws its own portrait of Jesus, so that we may see Him from four different points of view. And yet, all of them dovetail together to present Jesus (as Peter expressed so well in Matthew 16:16) as the unique Son of God.

Matthew has written with almost constant reference to the fulfillment of prophecy, and begins by showing that Jesus was the Son of David, and of Abraham, that He was the predicted King out of David's royal line. He intends for us to see that Jesus is the promised seed through whom all peoples of the earth are to be blessed; and the keeping of God's promise to Abraham. Mark ushers us immediately to the ministry of John who was to prepare the thinking of the Jews for Jesus. He intends to give us unimpeachable testimony about Jesus the miracle worker who went about doing good. Luke intends that we should see Jesus in His humanity, concerned and involved with all types and classes of people, and at the same time

to assure us of our faith in Christ with what he writes. John completes God's description of His Son with a book that is both simple and profound, an account that has inspired men and led them to search diligently about that One Who was before the beginning.

We can but rejoice in God's providence for providing a record at once so brief and yet so complete. Men would have written tomes on this subject, and would have not said as much as God did in the brief compass of the four books of good news, the Gospels.

It may be of interest to some of you who read this that though John's Gospel begins "at the beginning," it is not the one normally used as the first Gospel for translation into a new language. When a book is chosen for the first part of the Bible to be put into a new language which has never had any of God's Word in it, the translator must consider several things of great importance. For instance, he will want to present the person and work of Jesus to those who do not know of him. He will want a book with few figures of speech and a lot of narrative, since figures of speech are hard to translate into another language, and narrative is much easier. He will want a book that is both interesting and without a lot of references to the Old Testament, since the new reader will have enough problems trying to read (for he is just learning to do this), and any reference to a book which he does not have at all will surely hinder his understanding. The contrast between his religion and the Christianity in the New Testament will often be startling, with such concepts as a resurrection and one and only one supreme God being presented. The book with the least problems is a must. The Gospel of Mark is almost invariably chosen. It is short, presents the good news of Jesus clearly, and with a free flowing narrative helps to sustain the beginner's interest. Matthew's Gospel with its many references to Jewish

THE BEGINNING

customs and Old Testament texts, plus its greater length, makes it a real problem for the translator and the new convert or prospective convert. Luke's Gospel is really as long as Matthew's in content and includes a genealogy and allusions to Jewish customs that make it difficult also. John's Gospel is both lengthy and begins with a philosophical treatment of Jesus as the pre-existent Word, which would make it difficult in translation. So Mark is generally chosen as the first book of the good news about a Saviour, Who is Christ the Lord. May I challenge you to consider what you might do about putting the Bible into the language of someone who does not have it, perhaps because that language does not have even an alphabet, let alone a means to teach people how to read.

John's Gospel really starts at the proper place for a real understanding of Who Jesus is, with His relationship to the material world as well as the human race. The expression "in the beginning" reminds us that there is a definite point in time from which all things human are reckoned, as the identical expression in Genesis 1 does. John wants us to know that whatever point in time and space we would consider, the incarnate Word was present. He also affirms in plain language that He existed before this time, as an equal with the personality we call God. This is the message of the whole New Testament, whenever it speaks about Jesus and His relationship to God. It never presents Him as anything less than equal with God, nor did He ever affirm otherwise. We have those in our day and time who teach that Jesus was less than this. But they do not get it from anything Jesus taught, nor do we think they find it elsewhere. John affirms that Jesus possessed the quality which makes it imperative that we make Him no less than equal with God. It certainly is of interest to note that when Jesus claimed such, as in John 5:17, and the Jews understood His claim

in this light, Jesus did not correct them. Instead, He preached a sermon that clearly teaches that such a conclusion as the Jews drew was exactly what He intended for them to draw. Examples will be noted of other instances of this nature as we go along. It also is of interest to note that in verse 18 of John 1, many of the best manuscripts read the word "God" rather than the word "Son." It is not hard to see why the word "Son" would be inserted by copyists as they recognized the affirmation which this text made about Jesus' deity when it read "God." So they would be inclined to "tone down" such a clear statement about Jesus if they did not believe such.

We will find it impossible to completely understand the relationship of Jesus, in His divine state, to God, just as we will find it impossible to understand the relationship of Jesus the man to Jesus the God. The reason is this: we are finite, which means limited. How then do we expect to understand what is not limited and not finite? The Jews had this problem too, but Jesus did not attempt to explain the relationship as much as He did to display the fact of it. In Matt. 22:41-45 (Mark 12; Luke 20) Jesus attacked this problem as He asked the Jews about David's son being David's God. He did not attempt to explain it but rather stated it as a fact to be believed. God does not always give us an explanation of everything we are to accept by faith. This is one of those tenets of our faith which is not explainable. Note that Paul affirms the same fact that John does when Paul affirms in I Tim. 3:16 that God was manifest in the flesh. In the same epistle, the expression of 1:17 quite properly refers to Jesus Christ, since the immediate context from verse 12ff. has Him in view.

Sometimes people misunderstand the word "Son" as it is used in reference to Jesus. We can hardly expect that son should mean a physical relationship, since this

MAP NO. 1—PERIOD OF PREPARATION

1. Bethlehem/Jerusalem—Birth & Presentation in Temple, Lk. 2
2. Egypt—Flight from Herod, Lk. 2
3. Nazareth—Returns to spend boyhood, Mt. 2
4. Jerusalem—Taken to Passover at age 12, Lk. 2
5. Nazareth—Returns home until about 30, Lk. 2
6. Bethany beyond Jordan—baptized by John the Baptist, Mt. 3; Mk. 1; Lk. 3
7. Wilderness of Judea—Temptations, Mt. 4; Mk. 1; Lk. 4
8. Bethany beyond Jordan—obtains first disciples, Jn. 1
9. Cana of Galilee—Wedding feast, first miracle, John 2
10. Capernaum—moves headquarters with family and disciples, Jn. 2:12

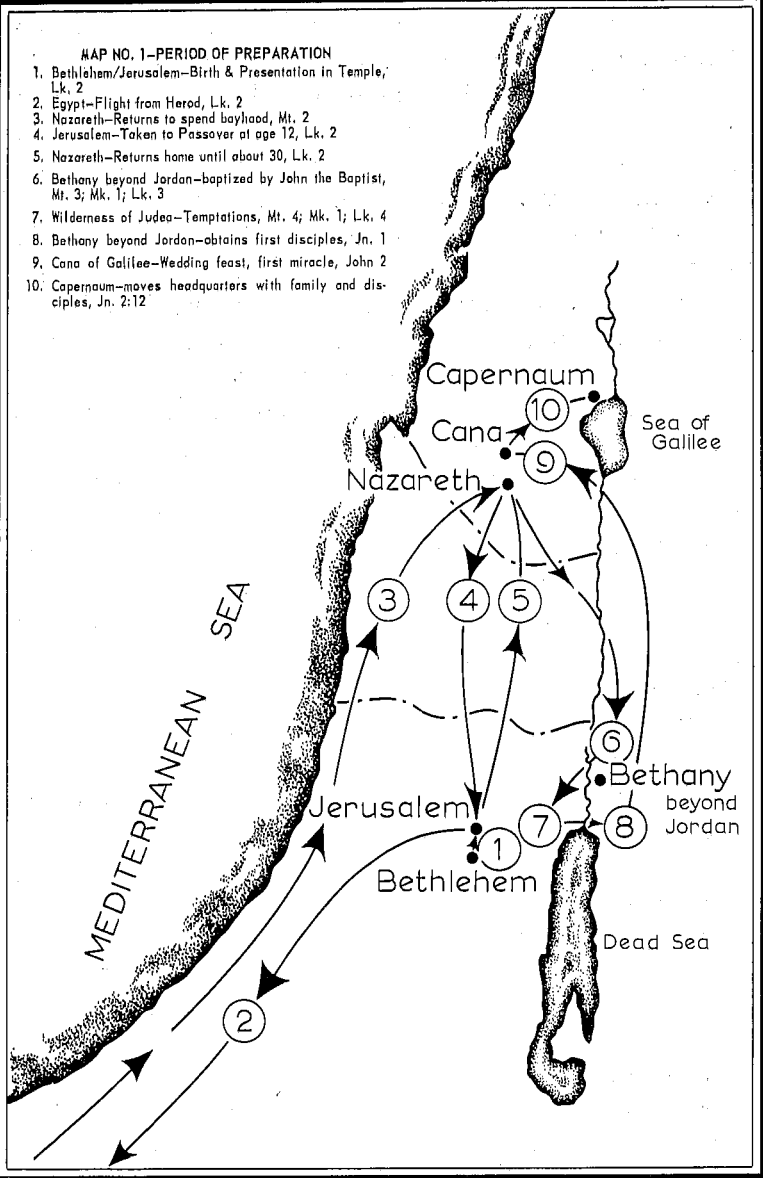



THE GARDEN OF GETHSEMANE AND MT. OF OLIVES

THE BEGINNING

would mean He must have a mother. This expression should be understood as referring to a given kind of relationship, as we find in Gal. 3:26; II Samuel 23:6; Deut. 32:8; John 8:39, 44; Rom. 9:6-8; Matt. 23:15 (child). We would grant that it sometimes means a physical relationship, but not always, anymore than father or children always mean a physical relationship. Context must determine how we understand the word.

John the apostle then introduces us to the forerunner of Jesus, who was not the light-giver, but rather the herald whom God prepared for this express purpose: to turn men's hearts toward the things of God. Prophesied in the book of Malachi, 3:1 and 4:5-6, Jesus affirms in Matt. 17:10-13 that God kept His word, and John the Immerser was that messenger, Lk. 7:27; Mt. 11:14.

This prophecy about John and the stated fulfillment by Jesus should focus our attention on this fact: scripture, whether prophetic or otherwise, must not be interpreted literally in every instance. Neither should it be considered always in a figurative sense. Maintaining either position dogmatically to the exclusion of the other can only lead to misinterpretation. If the New Testament states that a prophecy is fulfilled, we must accept such a statement without question. Elijah returned in the person of John, Jesus said. That settles it for us.

John the Baptist—Luke 1:5-80

The Gospel of Luke picks up the story by introducing us to the parents of John. They are both of the lineage of Aaron, devout and blameless in character, and also childless. For Zechariah and Elizabeth the last was a tragedy, since, among other things, it meant that they could not be the parents of the longed-for Messiah (to us, the Christ). To add to their woe, Elizabeth was now past

the age of bearing a child. But God is not hindered by the things that plague us as humans. So we read that as it came the turn of Zechariah to fulfill his week of service in the temple, in the course of Abijah, the eighth of the 24 groups of priests as appointed by David, I Chr. 24:10; II Chr. 8:14, God began to bring to pass what he had planned before the foundation of the world. It was at the hour of incense, perhaps in the morning, when Zechariah was in the Holy Place. Gabriel appeared at the right side of the altar of incense and expressed the first of many "Fear nots" to be found in the New Testament. He announced to Zechariah that Elizabeth would bear a son who would be called John. He would be a Nazarite, but more than this, he would prepare the hearts of his hearers for the Lord Who would follow. To Zechariah, it seemed so incredible that he was unbelieving. When he appeared to the waiting crowd, he was unable to speak and remained so until the birth of his son. This was the first indication to the Jews that God had begun to manifest Himself to them, after a silence of 400 years. We can hardly imagine the message which he brought to his wife as he went to his home in the hill country of Judah. Certainly the expression of Elizabeth as she speaks about the removal of reproach from her life is indicative of their great thankfulness.

God works in strange ways—His wonders to perform! To choose a husband and wife, though childless, to have a child is not out of the ordinary. We do not think it strange that God should bless them with a child. But to cause a woman to have a child when the woman is not married is an entirely different thing. Yet such was the case when about six months (vs. 26-38) later Gabriel again appears to a girl engaged to a man named Joseph, both of whom lived in Nazareth of Galilee. But God does not make mistakes. Mary was equal to the challenge

THE BEGINNING

of a life completely dedicated to His will. Would that all who read this be her equal in this respect. Informed of the task God had for her, she simply asked how it was to be done, and was told that God could accomplish that which He desired and she need not doubt.

You need to see that Mary was not ignorant of the things that would and could be said about her, but she was willing to place her life into the service of bringing forth a son Who would fulfill the promise of God to David, and Who would begin a kingdom that would have no end. Mary did not pray the world's commonest prayer, "Thy will be changed," but rather the world's greatest, "Thy will be done." She was aware that to be pregnant out of wedlock was not fitting for a woman. We can only admire her trust in the plan of God. Such is the life of faith.

The angel told her that her kinswoman Elizabeth was also expecting a child through the help of God. So she went to visit Elizabeth, and we are treated to the expression of Elizabeth as she greets Mary. We can only judge that the expression of Elizabeth was prompted by the Holy Spirit filling her life. The reader should note that the probability is that Jesus was six months younger than His kinsman John, but the text does not specifically say that Mary was with child at this time.

The verses of Luke 1:46-55 record for us the song of Mary, which resembles the song of thanksgiving by Hannah which she offered to God for her son Samuel. Mary's song is also filled with phrases taken from other parts of the Old Testament as well, which just shows us that she knew both God and His Word.

The rest of the chapter recounts the birth of John, his naming and the subsequent expression of his father about his son. Again the onlookers are treated to a display of God's handiwork. We can not help but wonder if

these people who marveled at the events surrounding John's birth heard of the events that took place in Bethlehem not many months hence, and if they did, what conclusions they drew. Surely Israel had not heard of anything such as this for a good long time.

Zechariah, in vv. 67-79, spoke about the destiny of his new son. In accordance with this destiny, John was a Nazarite, and reared in this way. Verse 80 tells us that he grew (in stature) and became strong in spirit, living in the wilderness area of Judea until he began to preach. We are not able to tell if John knew Jesus or not, though there is the possibility that he did so. Considering the exchange of words and knowledge between Mary and Elizabeth, we would be surprised if John's mother did not tell him about the events surrounding his birth as well as that of his kinsman.

THIRTY YEARS PREPARATION

Bethlehem—The Birth of Jesus—(Mt. 1:19-25)

Lk. 2:1-21

Mary's faith was really put to the test when she returned to Nazareth. If she was not noticeably with child at this time, she soon was, and the knowledge would cause Joseph to consider what he must do in respect to the situation. The tie of betrothal was as sacred as the marriage vow itself, and Mary could be stoned as an adulteress according to the law. But her chosen was equal to the occasion even as she was, and for this we again marvel at those whom God chose as parents of His Son.

Matthew tells us that Joseph was thinking about his action in regard to Mary. He recognized that Mary had apparently been unfaithful, but he had about decided to give her a bill of divorcement privately. The text says that he was a just man, which we take to mean both fair

and considerate of others. While he was yet undecided, he was treated to a heavenly vision, and informed that he was to marry his betrothed. He was told that the child was from God and that He was to be called Jesus for He was to save His people from their sins. Thus was to be fulfilled the prophecy of Isaiah about a son to be born to a virgin who would be called Emmanuel. It may be of interest that the Gospels do not record that this name was ever applied to Him by people.

This birth was apparently the second fulfillment of Isaiah 7:14 though some think otherwise. There has been a considerable amount of discussion over the Hebrew term, which is translated in various ways (virgin, young woman, etc.) depending upon one's idea of what it may or must mean. Whether we are ever able to decide about the Hebrew word, there is no doubt as to what the Greek term means used by Matthew. It describes a woman even as was Mary, who stated that she had known no man. With this we are content.

The statement by Matthew in verse 25 certainly indicates that Joseph and Mary had normal relationships after the birth of Jesus. The doctrine of the Roman Catholic church that she remained a virgin is another of their doctrines which is false, and really adds nothing to her dignity or holiness. If God ordained the marriage relationship, it seems to us that it is a holy relationship. And so the New Testament teaches, Matt. 19, Mk. 10. What is wrong with a woman who does what her Maker intended for her to do? If the reader will consider the texts in Matthew 13:55-56, with its parallel in Mark 6:3, these very plainly state that she had other children. We would grant that the Greek word translated "brethren" (KJV) or "brothers" (RSV) can be translated either way, and sometimes means one and then the other. But we do not find that the word "sisters" is ever so used. It

definitely indicates what we mean by the term. There would have been no point in the people of Nazareth mentioning the fact that Jesus had cousins. They were identifying Who He was in respect to His immediate family whom they knew.

Though the home of Joseph and Mary was at Nazareth, the sure word of prophecy had declared that the Messiah (Christ to us) was to be born at Bethlehem, the native place of His royal father David. So we read that a decree was issued by Augustus for a census of all the world over which his power extended, which would be the Roman Empire in that day and time. Matthew tells us that Jesus was born in Bethlehem during the reign of Herod the Great. Herod the Great was appointed king in the year of Rome, A.U.C. 714, which equals our time 40 B.C. He died in the 37th year after being appointed to this position. This would place his death about 4 B.C. according to our calendar and A.U.C. 750 by Rome's. The calendar we use was figured out by Dionysius Exiguus, a monk who lived in the 6th century A.D. Somehow in his reckoning of dates, he made at least a four year mistake. This is how Herod could die before Jesus was born according to our calendar, and yet have been the king who attempted to kill Jesus after He was born according to the Gospel records. If Dionysius had reckoned correctly, then A.D. 1 would have been figured from a point of time preceeding the death of Herod, who died just before the passover in his 37th year as king. It is impossible to determine just *how long* he lived *after* Jesus was born. Nor do we know if it was some months or some years before Herod's death when Jesus was born. The text in Matthew indicates that Joseph took his family to Egypt before Herod died, but it does not say how long he kept them there. Thus we are unable to determine even the year in which Jesus was born, let alone the day.

30 YEARS PREPARATION

December 25 is as likely as any other day. The Gospel records do not tell us and we conclude that they did not intend to tell us the year or day. Jesus was born to die, and it is His life and death with which we are concerned.

In keeping with the orders from Rome, Joseph and Mary went to Bethlehem for the census. The King James Version states that they went to be taxed, which was probably a result of the census which was the thing decreed. While they were there, God became a part of history in space and time. The birth took place in an unknown stable somewhere around or in Bethlehem. These three things are what it takes to make history: 1) an event 2) in space 3) and time. May we rejoice together that God came down to show us how to live as well as how to die.

Though they (Joseph and Mary) were both of the lineage of David, this did not procure for them any extra privilege in the town of Bethlehem it seems. But God does not neglect His own, though sometimes people do. So God graced a lowly stable by His presence. Not only this, but messengers from heaven, known to us as angels, appeared to shepherds keeping their flocks by night. How fitting that He Who is the "great shepherd of the sheep" should send angels on the night of His birth to those who were shepherds. They were directed to go to Bethlehem and there to witness what God had begun to do for His people. We cannot help but remind you that these men spread abroad in the country round about what they had seen and heard. It had not been long since the birth of John in the same region. Did *these events* cause people to begin to expect the Messiah?

Jerusalem—Luke 2:22-40

According to the law, Joseph and Mary went to the temple and presented Jesus as their first born, and offered

for Him a sacrifice that they might redeem Him. As He had been circumcised according to the law, so now He was bought back according to the law. While here at the temple, God kept a promise to one of His faithful servants called Simeon. Simeon's expression both to God and to the parents of Jesus contains both thanksgiving and a prophetic look at the future of Jesus. Anna also comes to offer her praise and thanks to God, and to go away speaking about Jesus to all who were looking for the redemption of Jerusalem. The reader should note that even now Jesus' world-wide mission is foretold as He was to be "a light for revelation to the Gentiles."

Bethlehem, Egypt, Nazareth—Matthew 2:1-23

The gospel of Matthew now takes up the story begun by Luke, and introduces us properly to the wise men. The character of Herod the Great coupled with the news of a new king for Israel threw the city of Jerusalem into a commotion. One of the Roman emperors had declared it would be better to be Herod's hog than Herod's son. The reason for this was that Herod was so insanely jealous that he would and did kill anyone that he thought to be a threat to his position. This would include even members of his own family, wife and sons for instance. So when the wise men came with the news of a new king for Israel, Herod immediately began to plot his death. He inquired from the wise men, as to the time of the star's appearance and of the Jewish scholars as to where the Messiah should be born. He then sent them on their way to Bethlehem, where they found Jesus and His parents in a house and presented to Him their gifts. They were directed through a dream to go back to their country another way.

When Herod discovered that they were not going to return to him, he sent his soldiers to Bethlehem to kill the

baby who was a threat to him. But God did not allow humans to thwart His plans. He sent a messenger again to Joseph and directed him to take his son and wife to Egypt. When the soldiers arrived, they killed all the boy babies in the area according to Herod's orders. Thus the mournful picture, long before drawn by Jeremiah under the image of Rachel, whose sepulchre was at their gates, was realized as the mothers wept for their dead sons, the first martyrs for Jesus.

The journey to Egypt also fulfilled a prophecy from Hosea 11:1 though we would never have known it to be true unless Matthew had told us. Here they remained until Joseph was again informed by an angel that Herod had died. When he got back to the land of Judea, he learned that the son of Herod named Archelaus was on the throne and was much like his father in disposition. So he took his wife and son and went to Nazareth. This was the home of Jesus throughout his boyhood days.

We should note here that the common pictures of the birth portray the shepherds and the wise men at the stable. The Bible does not even imply that the wise men were there. There are several reasons why we believe they were not there besides the silence of the Bible. *First*, they were from the East, perhaps Arabia or Persia or some other place. To have arrived at the stable on the night of His birth from some point that far east would have been difficult even in our time, let alone in that time. If the star which they saw did not appear until the time of His birth, there was no means of transportation available that could take them to Bethlehem the same night. *Second*, by some means unknown to us, they not only knew that a child had been born, but that he was born "King of the Jews." If they accepted the information as true, what was the hurry in going to visit him? They would have all of his lifetime to visit, so there would be

no necessary hurry in this regard. *Thirdly*, when Mary and Joseph went to the temple to offer the sacrifices to redeem their son, they offered the poor offering of two young birds. They should have offered a lamb according to Leviticus 12. Had the wise men appeared to them before this time, they would hardly have needed to offer the poor offering. *Fourthly*, when Herod learned of His birth, he sent his soldiers to kill all the children under two years of age. This age limit might have meant any child over one year old. Such an age limit would have been quite unnecessary if Jesus had just been born. The probable reason for such a limit was the fact that this would have enabled the soldiers to easily determine which baby should be killed. It is not difficult to tell a baby six months old from one that is walking and talking. With this age limit in mind, the soldiers would not have to ask the mother about the age of her son. If they were looking for a baby somewhere between the age of one to six months, and they killed all up to the age of about 18 months, they would be sure to get the baby in question. We should also remark that it is unlikely that more than 20 or 25 babies were killed since they had to be boys and only so old, and Bethlehem was not a large city. *Fifthly*, Mary went to the temple to present Jesus at the end of forty days according to the law. Matthew's account indicates that as soon as the wise men appeared and Herod knew about the birth, the family fled to Egypt according to direction of the angel. If the wise men had appeared before the forty-day period, they would not have been in the country let alone have gone to the temple in Jerusalem, the city where Herod was. We conclude that Jesus was over 40 days old and perhaps as much as six months old before the wise men came. The reader should also note that Matthew's gospel says in verse 11 that the wise men went into the *house* where they saw the baby Jesus.

Who the wise men were we do not know. They apparently were Gentiles who in some miraculous way had been informed by God that a baby was to be born in the country west of them called Judea. How they connected the star with His birth is also quite unknown to us. The text does not say that the star led them from where they were to Jerusalem. They apparently went to Jerusalem because this was the place where they could find out more information about the king who had been born. (We think the speculations about the star being the conjunction of certain planets is without any basis in fact.) Our sun is a star and not very big in comparison to other known stars. Do you think that such a star could direct one from Jerusalem the six miles down to Bethlehem and rest over the house where Jesus was? The star then was apparently as miraculous as the birth to which it bore witness. If it had been some large star like our sun, others would have noticed it besides the wise men. The text indicates that any miraculous event was quite unknown to the men in Jerusalem and the appearance of the wise men asking about such an event took them by complete surprise. We conclude that the star was seen only by the wise men, having been given for their benefit by God. The text does not say, but Matthew 2:12 implies that God also directed them to go back to their home and not return to Jerusalem to Herod with the news they had.

Jerusalem—Luke 2:41-52

The twelve years that passed before Luke takes up the account again, are years about which we can only wonder. Seemingly, Jesus along with his parents of course went to Jerusalem for each appointed feast, which is the probable meaning of Luke 2:42. However, the only thing that we are really told definitely is the statement in Luke 2:40

about Jesus growing and being filled with wisdom and having God's favor upon Him. We assume that Jesus was brought up according to the law by His parents, and taught as were all Jewish children to fear God and to keep His commandments.

At the age of twelve, Jesus was taken to the temple and there became a son of the law, obligated to obey its every precept. But this even is passed over in silence and we are treated instead to the discussion of Jesus with the Jewish teachers in the temple. It is interesting to note that they were not necessarily astounded at His questions but rather His understanding and answers. We know that even a small child can ask big questions. It is a different thing to indicate understanding and to show it in answers. Jesus certainly reveals His knowledge of His divine mission and His zeal for it. What an appropriate place to express such knowledge.

God's choices for the parents of Jesus were certainly wise and good. However, they were like all parents: they were human. Leaving Jerusalem at the end of the feast, each of them thought the other parent had their son along with them. They were apparently in company with other people and the men and the women did not travel in the same group. So they journeyed a day before they discovered that neither one of them had Jesus. The second day they returned to Jerusalem to seek Him. The third day their anxiety was well expressed by Mary, having found Jesus in the temple, when she said to Him, "Son, why have you treated us this way? Your father and I have been looking for you anxiously." We cannot help but wonder along with Mary at her son's reply. How much did He really understand about Himself and His mission? The reader should note that the expression in Greek is rather indefinite. It might almost be taken as a reprimand, for He says to them, "Did you not know

that it is necessary for me to be in the things of my Father?" He seemingly thinks that they should know about His mission, and so He contrasts the word "father" in His expression with the word in His mother's expression. But to show that He also knew what was required of any godly son, He returns obediently with His parents to the town of Nazareth. Here He grows to manhood, and increases in both wisdom, stature, and in favor with God and man, for approximately eighteen years. We would suggest that such growth in the areas mentioned does not necessarily indicate that Jesus was imperfect at any given time, but rather progressed in such growth as God ordained.

The town of Nazareth was not very well thought of by many people, as is indicated by the question of Nathanael in John 1:46. Yet we suppose that Joseph and his family had friends and engaged in the local public life, as is perhaps implied by the invitation of Jesus and His disciples along with His mother to a wedding feast at the neighboring town of Cana. We assume that Joseph taught his son a trade as did every Jewish father. It is pertinent to remark that we do not know what trade Joseph pursued. The Greek word in Matthew 13 and Mark 6 which is translated as carpenter does not mean what we mean by carpenter necessarily. It means any craftsman, whether a worker in wood or in something else. There is an old proverb that says, "Familiarity breeds contempt." This is not necessarily true but it seemed to be for Jesus and His hometown. Two different times (Lk. 4; Matt. 13 and Mk. 6) in His ministry, Jesus attempted to work miracles or to teach in Nazareth, and each time He was rejected. Did the problems raised at His birth cause such rejection?

Nazareth is not mentioned in the Old Testament, and occurs first in the Gospel accounts. It is hard to say

how big it was during the time of Jesus. It was apparently near the town of Cana and enjoyed a mild atmosphere and climate, being located in the province of Galilee.

It was in this town that Jesus began his mission of saving the world. That He well recognized all that was involved in that can be clearly seen in the fruit borne in His ministry. He had come to do the will of God, Heb. 10:9; Luke 22:42. In this place He prepared for that task. May we rejoice that the text in Matthew 2:23 "He shall be called a Nazarene" means for each of us that one person who was called that died for each of us, and His name was Jesus.

*The Jordan River—Matthew 3:1-17; Mark 1:1-11;
Luke 3:1-22*

The preceding narrative has left both Jesus and His appointed forerunner awaiting "the time of their showing to Israel." Jesus was at Nazareth and John in the wilderness. Suddenly, as Elijah of old, John appears on the scene as a herald of the kingdom, a preacher of righteousness and repentance, a voice in the wilderness, crying, "Prepare the way for the Lord." The reader will note that Luke accurately (in keeping with his intention) marks the time that this event occurs. Observe that two high priests are mentioned, Annas and his son-in-law, Caiaphas, though the Old Testament specifically prescribed only one at a time. But such was the problem with the Romans in power. Annas was deposed in A.D. 14 by Valerius Gratus, but managed to get Caiaphas put in the position. This will explain why the soldiers who arrested Jesus first took him to the "real" high priest, Annas, and then to the "official" high priest, Caiaphas.

30 YEARS PREPARATION

John had developed into manhood in the Judean wilderness (Lk. 1:80) in a rather ascetic life. The people remarked that he worked no miracles (John 10:41) yet because of his remarkable appearance and more remarkable preaching, they mused in their hearts if he might be the Messiah (Christ), Luke 3:15. Certainly his preaching stirred the ones who heard, and many admitted their sins and dedicated anew their lives to God. Jesus said of him that none greater had been born of woman, Luke 7:28. The office that he filled so well lends credence to this statement. Yet he knew that he was but a voice, a nobody. His mission was to prepare the road ahead for the "somebody" who was to come after him.

Malachi 3:1-2; 4:5-6 and Lk. 1:14-17 describe the work that he was to do by pointing out that the hearts of mankind must be changed before they could receive the coming one. So John preached that the "kingdom of heaven was near" and that people should repent and be immersed for the remission of their sins. For those who heeded, such a change of heart and life readied them for the appearance of the promised Messiah. Let it be noted that John's baptism demanded repentance as a prerequisite. It also was for the purpose of the remission of sins. The Greek text is the same in this respect as it is in Matthew 26:28 and Acts 2:38. God expected each Israelite to obey his voice, though some rejected the injunction, Luke 7:29-30; Matt. 22:23-32.

Because it was the will of God, many people came to be immersed by John. He admonished the publicans who came to practice honesty and moderation; the soldiers to abstain from violence, false accusations, and wrongful taxations of a subject people; and for the selfish to share with the poor. Sadducees and Pharisees, who claimed rather exclusive privileges because of their self-imposed importance, were warned that God could and would raise

up true children from the very stones upon which they stood. They were summarily warned to bring forth evidence of repentance. John pictured the Messiah as one who would divide the good from the bad, wheat from chaff, fruitful from fruitless, with the barren trees and worthless chaff being burned up. Reasons enough for a change of heart!

Among those who came was Jesus. We really are not surprised at His appearance, for He was one Jew Who desired to "fulfill all the righteousness of God." Disobedience on His part would have been sin. Thus, we have a very practical reason why Jesus came for immersion at the hands of John. The expression of John need not surprise us greatly, if his mother had told him anything at all about his cousin. We also note that God had spoken to him about an unusual event to happen, John 1:33-34, even if he did not know upon whom this would take place. His expression may well be simply an accurate appraisal of the true relationship that existed between them. He presented this same idea in John 3:30 as he spoke to his own disciples about Jesus.

God appreciates obedience! Because Jesus obeyed, God used Him, in His obedience, as an opportunity to express both audibly and visibly that appreciation. We will probably never decide if John alone heard and saw these things, or if others did also. May we rejoice that, though Jesus was the Son of God, yea, God Himself in human form, yet He learned obedience and became the means of eternal salvation to everyone who lives a life of obedience to His will, Heb. 5:9.

*Wilderness of Judea—Matt. 4:1-11; Mk. 1:12-13;
Lk. 4:1-13*

God did not intend that any human accuse Him of being unable to understand life here on earth by asserting

that "you have never been human." This is exactly the reason why Jesus was subject to what we call temptation. Is it not interesting to consider that God is a moral being, and has always had the power to choose evil rather than good? But we would not feel (I suppose) that "He has really seen it like it is" if Jesus had not been made a part of humanity. Therefore, the temptations in the wilderness present for our consideration the trial of the human nature of Jesus at close range. We ought not to think that this was either the first or the last time that Jesus knew temptation, even as a human.

The wilderness is made a very real place by Mark's statement that He was with the "wild beasts." Perhaps this occurred in the wilderness of Judea, around the vicinity of the Dead Sea. The text is just not specific enough to locate exactly where it took place, even to the "exceedingly high" mountain mentioned in the text.

Some suggest that the temptations were not only a subjective thing, but were experienced while Jesus was in a trance or ecstasy; and that the temptation and answer all took place within. Others make them subjective but while Jesus is conscious. The testimony of the accounts is that they were neither of these, but both objective and factual. Satan is presented as a real personality, and the possibility to sin was also real!

Some deny that the temptations were as presented because of the seeming difficulty about the devil taking Jesus to the pinnacle of the temple, or the apparent impossibility of presenting the kingdoms of the world from any mountain top. But to deny the reality because of our lack of understanding means that the whole gospel record is subject to our reason as regards its validity. Such a position is not one of faith. Others find problems with the apparent conflict concerning the order of the events as recorded by Matthew and Luke. Perhaps again it is

our understanding which is at fault. Luke may have a geographical frame of reference, whereas Matthew gives them in a time sequence, concluding the account with the statement of Jesus to Satan (which we might colloquially express as "Get lost!").

Who can really comprehend the depths of any temptation that comes in life, let alone fathom these that befell Jesus? Was it temptation to His physical self only? Such seems to be so for the first, but the third one does not fit so well here. It seems more to lean towards pride of position. How much of a temptation was it to Jesus to use His miraculous powers? Yet if He did so, what sort of example would this be for us, who are to follow in His steps? We would be quite unable to follow the Captain of our salvation in this respect.

Whatever view one takes of each of the trials, we would observe that each was presented with the idea that it was right. Is this not the way each one comes today? Consider the one who offers a drink of whiskey, or encourages a shot of dope, or lures with the promise of illicit sex: does not each temptation carry with it the implicit idea of "rightness" for the one tempted? But Jesus could see that more was there than met the eye. Again, Jesus knew the difference between trusting God and trying God. Would that we knew the same! True faith does not try God, rather it waits upon God. Thus, we do not advocate "Gideon's fleece" as a means to know God's will. If the reader will peruse Judges 6:36-40 carefully, we think that even Gideon knew that such was not the very best to do. Note verse 39 in this light. God may decide to answer anyway, even with such a way of ascertaining His will, but that does not mean it is the way that is best. Then, there is the implicit idea that one should decide what is best on the merits of the present circumstances, oblivious of anything apart from them. But Jesus taught

a vivid lesson that life is not godly apart from the adherence to absolutes, God's absolutes. God's Word is the criterion by which we may determine what is right and what is not. There are those in our time (as in every generation) that would have us practice situation ethics, or spelled out in a different way, the measure of all things is man himself. We can play our own god. Jesus did not so teach, nor should we so learn. Instead, the answer to each problem was the authority of the Word, God's never-changing absolute. Rejoice that He has given us a compass that never changes, and is adequate for each day's choices. Add to these facts the thought that it is Jesus Who ever leads us in triumph, vanquishing all the fiery darts of the evil one, and you have life victorious! "Day by day, and with each passing moment, strength I find to meet my trials here" can be our theme song for life. "Thanks be to God, Who gives us the victory through our Lord, Jesus Christ!"

The strength of any temptation is measured by its promise to present the "solution" to the pressing need, and as well by how subtle it is. Such were all the trials of Jesus. Know that the real strength of any trial is known only by the one who completely resists it. Our Lord knew all of these. He rejected the devil's suggested course of action by avoiding what was possible to do in favor of doing what was right. We must see that the devil's part is to suggest, but we need not accept. Jesus did not stand around arguing about the reality of the devil, nor his strength. He treated him as real, and spurned his purpose.

Let us then learn these lessons: 1) Satan is real, 2) temptation is common, 3) God's Word is our absolute (for life is not a series of unrelated experiences, but must be seen in the light of eternity and God's will for us), 4) Jesus understands our every need for guidance and help.

Vanquished, the devil left Jesus for a little while. He had real objectives in mind, even if some of the temptations are not understood by us. Some of the temptations may have been partly subjective (as in the third, for instance) but each was fraught with peril. Even the holiest of places was a place for sin to happen! We need not doubt that just as the devil was aware of Jesus, so is he aware of us. But may we rest our life in the hand of Him Whose eye sees each sparrow that falls, and Who knows each of His own by name. God has turned on the light marked "exit" for each temptation. May we be willing to see it, rejoicing that He has shown us the "way out" of every temptation to sin!

Bethany—John 1:29-51

"Come and see!" Thus does Jesus capture the men who followed in His train, men who had heard the "crying one" point out "the Lamb of God Who takes away the world's sin." The first disciples of Jesus were Andrew and John, each of whom brought their brothers to Jesus. Such is ever the way of bringing men to Jesus: personal witness and contact! John had disavowed having any mission in life except that of a mouthpiece about Jesus, of a beacon light for the real "light." Could we but determine to do likewise! The "senate committee for investigation of internal problems" had received no answer from John except this ringing affirmation about his one all-encompassing goal respecting Jesus. Might it ever be our song, "No other name but that of Jesus."

Akin to a clear ringing bell was John's remembrance of his first day at the feet of the Master. It was near Bethany beyond the Jordan, perhaps the place where Jesus Himself had been immersed at the hands of John. It was about the hour of 10 A.M. We would suggest to

the reader that a very rewarding study could be done in John's gospel concerning the occurrence of the word "hour" as well as other expressions of time. As we meditate on John's vivid recall of his first experience with Jesus, we think of those who are ever searching for some experience in life that is worth having, and of those who advocate having an experience, religious or otherwise, to validate one's life. Could they but seek and find Jesus, they would have an experience, and one that is worthy of remembering!

Bethany is a place whose location is not known, other than the remark that it was east of the Jordan river, thus to distinguish it from the one near Jerusalem. Origen had looked for it in his time (he was born A.D. 185, died A.D. 254) and did not find it. Notwithstanding the fact that all the manuscripts of his day read Bethany, he changed the name of this place to Bethabara, since that place he could find. But such textural treatment is hardly the mark of good scholarship, and it is best to leave the text as it is. So we settle for Bethany, and identify it as the place where some of John's activities took place.

John's places for baptism are identified as this place and the spot located at AEnon near Salim. It thus seems likely that John moved about as the circumstances dictated and the need arose. Whether Jesus was immersed at one of these two places or some other is a question which the New Testament does not answer, and is not really important anyway.

"An Israelite . . . who is not deceitful!" This was the discerning observation of Jesus about the find of Philip: Nathanael. How wonderful the news to carry, as did Andrew and Philip, that they had found the One Who was the subject of Moses, and of the prophets. We hardly appreciate their joy from this distance. For them, John had pointed the way, and Jesus was there! How

like the man in Matt. 13 who found the treasure in a field, or the one who discovered the pearl of greatest price. These men left all to grasp this most worthwhile of all prizes!

Guilt by association! Such was the conclusion of Nathanael when told that Jesus was from Nazareth. What was wrong? Was it because Nazareth had a feud going with Bethsaida? Or was it just Nathanael who so felt? But Jesus was equal to the occasion, as was Philip. The word was again "Come and see!" In coming, Nathanael, as the others, found Him "in Whom are hidden every treasure both of knowledge and wisdom," Col. 2:3-4. Greater things were yet to come, but Nathanael was content to wait, and just enjoy his present possession.

Cana of Galilee—John 2:1-11

This city is not mentioned in the Bible except by John. One had to go down to Capernaum from Cana, John 4:47, 49, 51, so it must have been in the hills of Galilee. The exact location has ever been a problem, since there are two villages north of Nazareth claiming the honor. Here Jesus displayed His first sign (John's word for miracle) which was to build some faith in His disciples.

Life as usual! A marriage! And John reports that it was the "third day" in a series of days, probably reckoned from John 1:43. He, along with other disciples, went with Jesus to this happy event. What a day, and what a wedding! One often reads that the Scripture does not mention the fact that Jesus ever smiled or laughed. It seems unlikely to us, though, that He attended a wedding and did not allow the corners of His mouth to ever turn up. What did He imply in the text in Matt. 9:15 about normal conduct at a feast such as this one?

However, not everyone was smiling as the feast progressed, for the cupboard grew bare too quickly, and thus the stage was set for the first of signs that John records to provide a basis for faith.

"The wine is gone!" would be a good statement sometimes, but not on this occasion, for the guests were still present, and the feast was not over. The wine having come up short, consternation was the order of the day in the kitchen of the host. What to do? We will never know just why, but the mother of Jesus informed her Son of the situation. He replied, "Why do you bother Me with it? What relationship exists between us that causes you to tell Me this?" Thus we reproduce what seems to be the gist of the Greek expression. The reader can see a like expression in Luke 4:34 and also in Matt. 8:29 in another place and time. How Mary took the expression is best seen in her response to it. She told the servants to do whatever Jesus said to do. That is good advice anytime, is it not?

"Keep taking it!" (the wine newly made). Thus did the servants for the duration of the feast. The servants may have been the only ones who ever knew how the supply of wine was renewed, other than the disciples of Jesus. It seems to us that the water placed in the waterpots was what was drawn out, which became wine, and was taken to the steward. It does not make much sense to have the servants fill up 6 large waterpots with water, and tell us about it, and then assume that the water drawn out was not from those jars. We do not think that the remark of the steward, upon tasting the wine, necessarily implies that the wine was fermented, as we will state in the following paragraph.

What was the wine? Was it a fermented beverage? Some so believe and teach. We do not so believe and teach. The case seems to be as follows to us. First, if Jesus were

God (which we accept as the fact), then He was the actual author of the Old and New Testaments. Consider then the texts like Proverbs 20:1; 23:20-21, 29:35; I Cor. 6:10. Would Jesus say such things and then provide the means to do what is said to be a bad thing to do? Is Jesus consistent with command and example? You may argue over the definition of "drunkard" but it is not wise to play Russian roulette with God. How do we know when God considers one to be drunk? The only sane course is complete abstention. Secondly, the word "wine" definitely is not always used to mean fermented beverage. It was not so used by other writers of that day. Nor do we think it is in the New Testament. Consider the text in Matthew 9:17. The expression "new wine" can not mean a fermented beverage, or else it would not be capable of expanding and thus bursting the skins. It rather describes a juice quite unfermented. The Greek word is used by contemporaries of the New Testament writers to describe a syrup made from boiling grape juice down, a beverage made from combining water and this syrup, the grape juice both out of the grapes and still in the grape, and even the grapes themselves. So we do not think that the word necessarily means a fermented beverage, here, or any place else, including I Timothy 5:23.

Capernaum—John 2:12 (ref. Matt 9:1; Mk. 2:1)

Conspicuous by its absence is the word about Capernaum. It certainly is of lasting interest that this city, so vitally connected with Jesus' ministry, is proof of the accuracy of Jesus' word. He condemned it, along with Chorazin and Bethsaida, to oblivion because of the unbelief of its people. His remarks, Matt. 11:20-24; Luke 10:13-15, about these cities clearly show that the vast majority of Jesus' ministry is not recorded. The com-

monly accepted length of Jesus' ministry is somewhat over 3 years (as we assume to be true), yet less than 100 of over 1,000 days are mentioned in the written accounts.

Seemingly named for someone called Nahum, the reason why Jesus moved His ministry to this city is not stated. Whether the ruins of Tel Hum or Khirbet Minyeh are those of Capernaum is not known, but Tell Hum is more likely. These ruins are along the north coast of the Sea of Galilee, about a mile long, and about 2 miles west of the Jordan.

The Gospel writers mention many historical events about the "city" regularly so-called. It was the home of Matthew, whose tax-collecting business was located in a city on a major trade route. Zebedee, and his sons James and John, lived there; and likely Peter and Andrew (compare Jn. 1:44 with Matt. 8:14). It is the only place where Jesus was said to be "at home" Mk. 2:1 (read here Luke 4:23).

The centurion who built the Jews a synagogue had his servant healed (Matt. 8; Lk. 7); a man's withered hand, Matt. 12; Mk. 3; Lk. 6, and a man possessed of a demon, Mk. 1; Lk. 4, were healed in its synagogue, where the Sermon on the Bread of Life, Jn. 6:25-65, was heard. A paralytic, Matt. 9; Mk. 2; Lk. 5, an official's son, Jn. 4:46-54, and Peter's mother-in-law were healed there. In the evening after Peter's wife's mother was healed, the city folk kept bringing their sick to Jesus, and he kept healing them, Matt. 8; Mk. 1; Lk. 4. Jesus sent Peter down to the city's beach with a hook and line to catch a fish with money for the temple tax, Matt. 17. These are events that make this city important in Jesus' ministry.

FIRST YEAR OF MINISTRY

EARLY JUDEAN MINISTRY (8-9 MONTHS)—

JOHN 2:13—4:2

Jerusalem and Judea

Jerusalem! Jerusalem! Those words bring many, many important things to mind: David, its great king—Jeremiah, who wept over it. But a greater than Jonah or the temple, or these two men, could not bring it to its knees in repentance. Oh, Jerusalem!

The feast of Passover brought orthodox Jews together yearly. Jesus etched this Passover (A.D. 27?) on the minds of many who no doubt watched with eyes wide as He cleaned house, and warned about making the temple a place of merchandise. The enigmatic remarks about destruction of His body were remembered, as the trial accounts testify.

The account in John, extending through 4:3, contains some important teaching about the potential citizen of the kingdom, the king of the kingdom, and the forerunner of the king.

The ministry of Jesus is a many-splendored thing, and yet it constantly emphasizes one fact: God directed it entirely. Men would have misused it in some way, and because Jesus knew the makeup of His creation, He would not allow His ministry to be directed by man.

The obvious result of a ministry with God's help is stated by Nicodemus in 3:2. People like the disciples, Simeon and Anna, and others could see this fact, even if some would not see it. A number of the Pharisees believed in Jesus, Saul of Tarsus ultimately among them.

We do not know why this ruler of the Jews came by night to Jesus. We do know that he finally committed

MAP NO. 2—FIRST YEAR OF MINISTRY

1. Jerusalem—Passover, cleanses Temple, talks with Nicodemus, works many miracles, Jn. 2 & 3
2. Sychar—about 9 mos. later, talks with woman at well, Jn. 4
3. Cana of Galilee—Heals nobleman's son sick at Capernaum, Jn. 4
4. Nazareth—Preaches in synagogue, first rejection there, Lk. 4
5. Capernaum—2nd call of fishermen, preaching tour, heals man let down through roof, call of Matthew, controversy about eating and fasting, Mt. 4-8-9; Mk. 1-2; Lk. 4-5

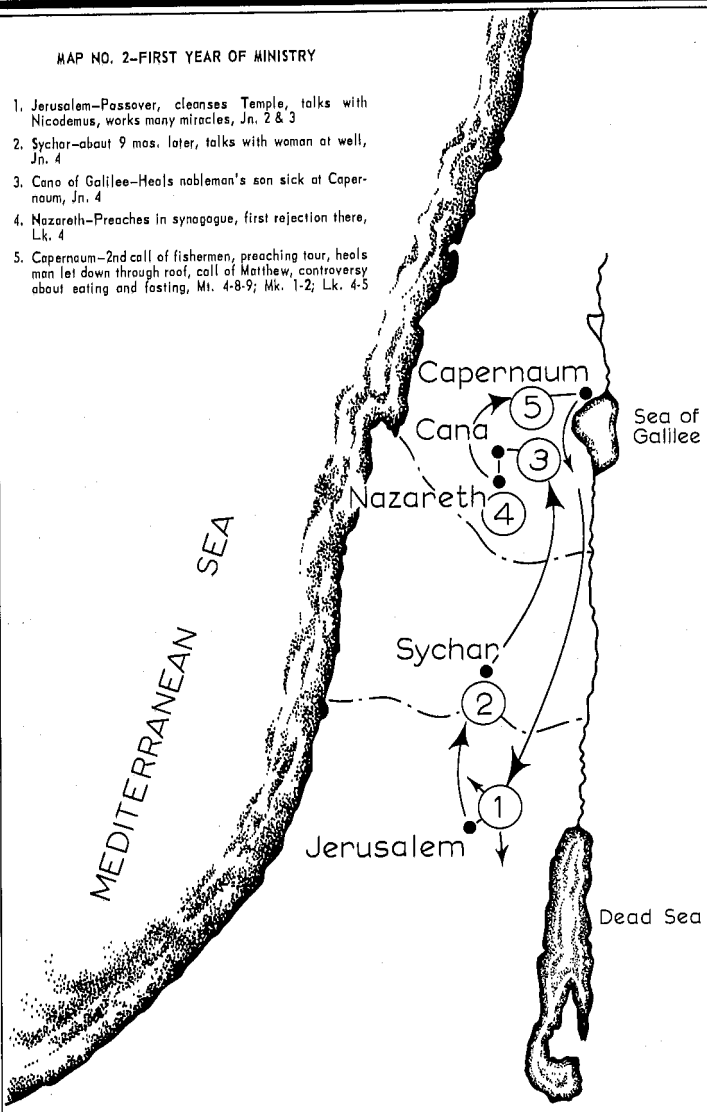



THE TOWN OF BETHLEHEM

himself to Jesus, though some three years would pass before he openly did so, Jn. 19:39.

Jesus, like 2:24-25 says, knew what was in the man who came to Him, so He answered the unspoken question directly. Heb. 4:12-13 states the fact which we see in our text.

Jesus was seemingly surprised that Nicodemus did not understand a basic principle of the Bible, which is that "like produces like" as stated in Gen. 1. He should have known that things material or physical do not produce things spiritual, or vice versa. If one is to become a part of a spiritual kingdom, then a spiritual birth is necessary. God uses the analogy of a physical birth to help explain the process of becoming a new creation.

The analogy of physical birth to spiritual birth is evident, but the question comes: how much is to be considered as being the same in both realms? The reader should know this fact: an analogy proves nothing, it only illustrates. Jesus states one similarity: a birth is needed to become a part of the flesh, and so it is in the realm of the spirit. Nothing else is stated explicitly. Hence, the religious world has argued for centuries over this passage.

Some declare that the *water* and the *spirit* are like a mother and father. But others insist that the "mother" precedes the "father" (water before spirit) and that order in time is not so in the physical realm. The conception must take place before the water is present. For those who argue that the order of words in a passage necessarily proves order in time, consider Acts 20:21.

Some argue that, as the human child has nothing at all to do with its birth, so it is in the spiritual realm. The Holy Spirit moves (works) as He wills, and only those in whom He works are born again. Some who hold this position hold that the word 'water' in the text means 'spirit'. Thus Jesus says, ". . . spirit, even the spirit."

NEW TESTAMENT HISTORY: THE CHRIST

Considering other passages, we conclude that the following is true: 1) man is created as a moral creature. Implied: the right of choice. 2) the spiritual world known as heaven is entered only by choice. 3) The Holy Spirit, through His sword, the Word of God, presents the option of a new birth to all who hear the word. 4) Those who choose to become a part of the spiritual kingdom are considered as new babes in Christ. Consider the following Scripture for each point: 1) and 2) Gen. 1:26; Deut. 30:15-20; Josh. 24:15; II Chron. 7:14; Matt. 7:24-27; Jn. 14:1-3; Acts 26:16-18, 28; Rom. 10:17; Heb. 3:12—4:3; Rev. 20:11-15; 21:6-8; 22:17. 3) Lk. 8:4-15; Acts 2:37-40; 10:34-35; 11:14; 13:38-39; 15:9; Eph. 6:17; I Tim. 4:16; II Tim. 1:10; James 1:21; 4) Eph. 4:11-14; Col. 3:16; Heb. 5:11-14; I Pet. 1:22—2:2.

Jesus teaches that what Nicodemus heard he should believe, since Jesus is the one who came from heaven, v. 13, and thus has the authority to so speak. God had centuries earlier given a type of Christ in the serpent made by Moses. Even as the people had to do, Num. 21:4-9, for physical life, so does the seeker for spiritual life: he must look (an act of the will) to live. Looking is an act of faith, since we can in no way prove we will receive life until we do. Faith does not become sight until we enter the place called heaven. But there is certainly no other system on earth among men that offers either as much reason for 1) faith or 2) hope as the Christian religion. God has seen to that. It is plain enough that all who run may read, Habakkuk 2:2; Acts 10:34-35; nor was it done in a corner, Acts 26:22-26; I Cor. 15:1-11; and it is a more sure word, Heb. 1:1-3; 2:1-4; II Pet. 1:16-21.

To show that Jesus was to be understood that both God and the would-be disciple are involved in the new birth, the first people who ever became Christians as a

result of hearing the Gospel preached are found in Acts 2. Peter preached God's message, and those who were willing to accept the message were told to repent and be immersed, v. 38. Upon doing so, they became a part of the body of Christ, thus "in Christ" and, as such, new creatures. This well illustrates the way to be born again. If not, why did the Spirit direct Peter and the apostles to do and say what they said and did in Acts 2?

Whether Jesus utters 3:16-21 or not (the red letters will not tell you—the Greek text written by the apostle John did not have red ink for Jesus' words) is not important. What is important is the fact that we have a choice, and our life will definitely tell which choice we have made.

The final section in 3:22-36 brings to our attention a dispute about purifying (it was not the last dispute over how a person is purified in God's eyes by any means). Some supposed a rivalry between John and Jesus, but as John plainly shows, it was all in their minds. His whole life was given over to service as God directed. Would that all who read this be able to utter 3:30 as their own philosophy of life.

Again, whether 3:31-36 is an expression by John the immerser or John the writer (and apostle) is impossible to tell. But the text shows why men should accept Jesus: 1) He is from above, 2) He utters God's words, 3) He has the Holy Spirit without measure, and 4) those who accept Him *now possess* eternal life (see II Cor. 1:21-22; Eph. 1:13-14) and those who do not *now have* God's wrath abiding on them. Therefore, everyone who is alive, at any given moment, is either saved or lost. The difference? In Christ or not in Christ!

The reader should note that 4:2 does not say that Jesus immersed only His disciples, or that only His disciples immersed others. 3:22 seems to teach that both

Jesus and His disciples immersed. 4:2 only says that at the time of our text the disciples of Jesus were immersing people who came to hear and believe the message preached.

This ministry consumed some time, and the rest of the 8-9 month period was spent in "making and immersing more learners" than His forerunner, John. But the ungodliness in the godly got the upper hand, and Jesus became unacceptable to (godly?) leaders in Jerusalem and Judea. He leaves and goes to Galilee where he ministers about 4 months (Jn. 4:35 gives a point of time during this year) preceding the second Passover and through all of the second year of ministry.

We ought not to think, though, that Jesus did not minister anymore to this city, even if the accounts of Matthew, Mark and Luke do not record events there until the final week. The texts in Matt. 23:37-39 and Luke 13:34-35 (and implied in Luke 19:41-44) show clearly that Jesus did do so. John's gospel shows some of that ministry.

Noticing the many in the Judean area who were either immersed by Jesus or John, we wonder if the "famous" thief on the cross were not among them. It is often said that he was not immersed, but silence proves nothing. It is just as probable that he had heard Jesus and was immersed. How else would he know about a kingdom Jesus might have? Why did he call Jesus "Lord?" Do not these things show he knew something about Jesus and His ministry?

"They remembered." So John marks the fact that the apostles also recalled what Jesus did at this first Passover (verse 22). Many saw His "signs" and became believers in Him since signs gave clear evidence for the deity in His life. The hearts of many in the city were not changed, however. Like the three cities of Galilee, unbelief marked the city for destruction, Matt. 24, Mk.

13, Lk. 21, which ultimately occurred in the years A.D. 68-70. How few really could catch the spirit of John, whose life was given over to "decreasing" while Jesus "increased." Would that each reader of this historical remark (John 3:30) determine that, whatever others may do, he or she will be like John, rather than the many in that day and time who refused to do God's will (see Lk. 7:29-30; Matt. 21:23-27; Mk. 11:27-33; Lk. 20:1-8).

Sychar in Samaria—John 4:3-42

"Put in the sickle, for the harvest is ripe." Full heads of wheat hanging down! The unmistakable signal to the experienced eye that it is time to roll the combine out. But the eyes of some disciples with Jesus were unseeing when it came to another type of ripe harvest field among a despised culture. Jesus was not blind though! A sharp command issued to these disciples jarred their eyes to seeing, and revival came to the Samaritans of Sychar. The lesson: God sees only a world lost. Reprimand: We, having eyes to see, see not! How else do we answer for the obvious status of 3 billion people . . . lost? Surely God is not willing that they perish, nor is He unable to save them. The other factor in salvation is the human element: us. Do you know a ripe harvest field when you see one?

"The well is deep, and you have no rope." Perhaps the only place which we can surely say was graced by Jesus' presence, and go to it ourselves, is Jacob's well. Four thousand years of history are bound up in a little spot near the base of Mt. Gerizim, some 31 miles north of Jerusalem, and 5 miles southeast of Samaria. It is probably to be identified with the well known today as Bir Ya'Kub. Of course, like many other things in Palestine, it has been glamorized. But when Jacob purchased the land from the

sons of Hamor for the sum of 100 pieces of money, it doubtless was not much for a tourist attraction. Tradition among the Samaritans had Jacob digging it, v. 12. McGarvey suggested that the presence of the well is somewhat of a mystery, since the area seemingly had a copious supply of water otherwise. He posited the reason for the well was that Jacob dug it to be independent of his neighbors. It was then (1879) about 66 feet deep, filled up with rocks, etc., thrown in by visitors (Lands of the Bible, p. 283-284). Today water from the well may still be had to satisfy the thirsty. Some today identify Sychar with Shechem, though others do not.

Two vivid facts, among others, Jesus called to the attention of the women and, as well, to us. One is that God is not restricted to any one culture or time. He is rather the God of all historical times and places. Such is Paul's implication in Acts 14:14-17 and 17:22-31. Another is like unto the passage in John 3:6. We are spirit beings, living in a fleshly tabernacle (note John 1:14 coupled with 4:24 "deity is spirit"; and then Genesis 1:26). This type of being is sought by God to render adoration to Him, v. 23. Never regard yourself as "just" human. That is truly untrue! Any system of philosophy which teaches that man is just flesh is anti-Biblical. Man is not the measure of all things. The many differing philosophies, unless solidly Biblical, offer no absolute from which to reckon. This leaves man no mooring point, no universal, and he is left with only particulars. Hence philosophy is a bag with holes in it. The Christian reckons all things from an absolute (God) which never changes. The universal provides a pattern for all the particulars. Hence, every aspect of life can be fitted into a unit, Rom. 8:28. We are not left with loose ends. Modern jazz, art, literature, theology—all are full of the philosophy that there is no God. With no absolute, it is then no wonder that

FIRST YEAR MINISTRY

modern man tries drugs or Haight-Ashbury, or suicide. It is scriptural to "not consider ourselves better than we should" Rom. 12:16. Yet it is also plainly taught that we ought to live as we are: created in the image of God, and not think of ourselves as only flesh and bones, Col. 3:1ff.; Mk. 8:34-37, and our text.

The Samaritans needed to learn the lesson that their worship needed correction; their views, attitudes, and practices harmonized with God's will. They had problems but so did others. We have problems, but so do others. God has answers for all. Though despised by the Jews as offspring of intermarriages of Jews with Gentile peoples in prior centuries, yet Jesus was interested in their life, and satisfied Himself with service to them. Interestingly enough, they confessed Him as the Savior of the world, a step not even taken yet in their thinking by His disciples (note John 1:41-49; Acts 1:6).

This interview of the woman and Jesus offers a great study in personal evangelism (taking a person where he is and leading him to greater faith), and the psychology of dealing with others. Note also the progression of the woman in her attitude about Jesus: 1) a Jew (an obnoxious culture), 2) a possible help (thirst-quenching water), 3) a prophet, and 4) possible Messiah. The Greek of v. 29b has the woman saying something like "This man can't really be the Messiah, can he?" She expected a negative answer from the villagers, but she might have only expressed herself thusly (when she actually believed Jesus to be the Messiah) to keep from creating prejudice in the minds of the hearers. Consider the response of those who believed in verse 42: their expression indicated that they had concluded this idea, too.

The life of faith in Christ is an ever-abounding one, even like an artesian well. The woman really received a

lasting drink at the well, not only for herself, but many others as well.

This is a good place to remark about Jesus' humanness again. Consider the following references to Him as starters: He was both tired and thirsty here, compassionate Matt. 9:36, obedient Matt. 17:24, hungry Matt. 21:18, sorrowful and desirous of companionship Matt. 26:37, angry Mk. 3:5, amazed Mk. 6:6, indignant Mk. 10:14, loved Mk. 10:21, astonished Lk. 7:9, grieved Jn. 11:33, wept Jn. 11:35, (would be) joyful Jn. 15:11. He did not play at being man!

GALILEAN MINISTRY (1 YEAR, 3-4 MONTHS)

Cana of Galilee—John 4:43-54

Nicodemus was not the only observer of Jesus' miracles at Jerusalem 8 months earlier. Jesus' Galilean countrymen also did. Yet to condition faith only on such is but to be reprimanded by Jesus, v. 48. We (like the nobleman) need to learn that faith does not limit God (Jesus did not need to "come down" to the place where the son was, some 18 miles northeast at Capernaum); and with Jesus, it is not "it may be true" but rather "it must be true." Invariably Jesus takes us where we are and attempts to lead us where we ought to be. When we follow in obedience, we will find that it is even as He has said. Faith is the key that unlocks the door.

Cana of Galilee is generally identified with modern Kefr Kenna, 4 miles NNE of Nazareth. But some, including modern Arabs, hold for a site 9 miles north of Nazareth called Khirbet Kana. Nathanael made his home here, Jn. 21:2, and of course, Jesus had friends here (see Jn. 2).

Nazareth—*Mt.* 4:12-17; *Mk.* 1:14-20; *Lk.* 4:14-30

"Anything good . . . from that city?" Perhaps it was experience that dictated these words, or maybe repeated hearsay—but Nathanael's response, *Jn.* 1:46, was answered by Phillip's reply to "come and see for yourself." An affirmative answer can be given Nathanael, for Jesus came out of Nazareth.

When Jesus arrived in Galilee, under the agency of the Holy Spirit, the people of Nazareth apparently welcomed Him. Time changed that response however. Acclaim became anger, and unbelief asserted itself in attempted murder, ere Jesus left His boyhood home, in the first of two recorded visits there. One is reminded of Isaiah's statement in 65:2, "All day long I have pleaded with a disobedient and contrary people . . . but to no avail."

Prophecied events became historical facts when Jesus ministered in Galilee. Isaiah 9:1-2; 42:7 and 61:1-2, as well as Simeon's words in *Lk.* 2:32 all speak of this general fact about the Galilean ministry. It is appropriate to point out, in view of the current trend of scholarship to apportion the book of Isaiah among several men, in different centuries even, that the Bible statements about this ministry are basically from chapter 9 and 61. Both quotes are attributed to the prophet Isaiah. It seems to us that if someone other than Isaiah himself wrote these passages, then God has surely misinformed every believer for the last 1900 years. We are not inclined to that conclusion. When Jesus spoke in the Nazareth synagogue, it was as if He said, "God promised I would come . . . here I am." A new day dawned in the hearts of some in Galilee of the Gentiles. But for others, prejudice, familiarity, ignorance (who knows?) caused them to miss the light of the world.

How awful to sit in the region and darkness of spiritual death and not avail oneself of light, free for the taking.

Nazareth gave Jesus identification in history: time, place, event. Some in Nazareth gave Him a home in their heart. Most had no room for Him, since He did not fit the place they determined He must fit. An apt reader will take this lesson to heart.

Situated in a high valley in the southern hills of Galilee, just north of the plain of Esdraelon, in what was the portion of Zebulon, Nazareth lay some fifteen miles SSW of Tiberias, and about twenty-two miles SSE of modern Haifa. Some think that the root of the name means 'watch-tower' since the town lay just south of a main road from Ptolemais (just north of modern Haifa) to the Decapolis area. Nazareth overlooked the valley of Esdraelon (Greek form of Jezreel, which name is loosely used oftentimes to designate both the valley of Jezreel and the valley above it to the NW called Esdraelon) which provided an unimpeded passage from the Mediterranean coast to the Jordan. Others suggest the meaning 'shoot' or 'branch'. It is noteworthy that the town does not appear on the pages of the Old Testament.

Capernaum—*Matt.*, chs. 4:18-22; 8:14-17;
Mk. 1:16-34; *Lk.* 4:31-41; 5:1-11

Principles in one area of labor can oftentimes be used advantageously in another area of labor. Jesus challenged James and John, Peter and Andrew, to pursue the art of catching men rather than fish. These four men, who had now known Jesus for at least a year, were called to leave their means of livelihood in fishing to full-time labor in evangelism. It is easy to see why they so readily left their nets to follow Jesus, having been with Him part-time prior to this call. Having witnessed such miracles as per-

formed at Cana, and in Judea, coupled with helping Jesus in evangelism, John 4:2ff., we can readily appreciate their response to His call.

"Depart from me . . . Lord." We, as Simon Peter, need to thank God often that sometimes we are not answered as we have asked. Our experience with Jesus is not different than Peter's: He has something to make us "stand amazed" in His presence every day. It may be an answered prayer, a disguised blessing or countless other things that He knows how to fit into our lives. May we be as discerning as Peter in our awareness of Who Jesus is.

Have you ever heard an echo? Many people in the land around Capernaum did, for the expulsion of the demon for the man in the synagogue was repeatedly told to listening ears. Jesus had authority, and the demons invariably obeyed Him. He never failed to command obedience from them. He never accepted testimony from them, though they knew Who He was, and so testified. May we learn the lessons 1) through Christ we can overcome any and all evil, and 2) never allow ourselves to find comfort in what the devil (or his helpers) might say about us. People might rightly wonder about our relationship to the source!

Some in our day say that such events as this one, recorded as being historically true, are actual lies. Some would say that there are no such things as demons. (The rendering in some translations of the word 'devil' for the Greek word is not correct. There is only one devil, but many demons.) There are three possibilities about Jesus and demons: 1) Jesus knew there was no such thing as a devil (and demons) but went along with the beliefs of the people. We do not think Jesus would implicitly teach an untruth, which is what this would be. In essence, this sort of action would be lying. 2) Jesus Himself was deceived as to their reality. If so, how do we trust Him

for anything He taught? He, Who knew what was in man, deceived? 3) Jesus actually did what the accounts say He did. This is the only valid conclusion. If we deny the accounts because we have not experienced such in our day, or others like ourselves have not, then we make experience the ultimate truth. We throw out then any historical fact contradicting experience (that is, experience which we accept as valid). Again, man becomes the measure of all things. We have little patience with such a philosophy, which implicitly denies that the N.T. writers did record events factually. We accept the Bible accounts to be fact, and true. Let God be found true, and if need be, every man a liar!

The Sabbath day ended at sundown, but too many heard about the day's work in the synagogue. So Jesus "worked" at healing far into the night, for the people kept bringing their sick ones, and people possessed with demons, and Jesus just kept on healing. Truly Jesus spoke through Isaiah and foretold that "He would take (our) infirmities, and bear (our) diseases," 53:4.

We need only to remark that the record shows that Peter was married, I Cor. 9:5. How far astray is the doctrine that teaches that marriage is honorable for all . . . except preachers of the word. God warned that such false teaching would come, I Tim. 4:3, and it did. How much better to believe God rather than obey men. Multitudes in history, as well as in our day, have rejected such doctrine which is taught with all sorts of evil resulting and they have done rightly.

*First Galilean Tour—Matt. 4:23-25; 8:2-4;
Mk. 1:35-39, 40-45; Lk. 4:42-44; 5:12-16*

The echoes of such things as happened in the synagogue soon made Jesus a personality in demand. As the

disciples aptly expressed it, "Everybody is after you," Mk. 1:37. One notes the great crowds everywhere, and the inner compulsion of Jesus to satisfy such demands in this first major tour of an area where both Jews and Gentiles lived. Imagine the many caravans from all points which passed through this small area, almost of necessity (unless they went up the east side of the Jordan in Perea), and the news that greeted their ears about a miracle worker. Few would be disinterested in this.

Many were rather desperately interested. One leper, of many, fell on his face, and beseeching Jesus, asked for cleansing. The leper felt that Jesus held the answer—he was right. We can hardly appreciate his position, for he could not share in family life, or temple worship, or aught of things considered important. We can barely share his joy at being cleansed, restored to family, friends, life. Yet perhaps the leper is not unlike the sinner. The sinner is an outcast from the good life, for only Jesus had life, Col. 3:4. The sinner is dead (Eph. 2:1), so how can he share life?

You may note that Jesus invariably kept the law, and instructed others to do so. The leper was not treated differently, for he was sent to the priest to do as the law prescribed. For those of you who have not yet read the study on leprosy, now is the time to do so.

*First Galilean Tour (2)—Matt. 9:2-17; Mk. 2:1-22;
Lk. 5:17-39*

Another was intensely interested in Jesus: A paralytic who had four friends. So desperate was he that his friends took up a part of a tile roof to place him with Jesus. Jesus, seeing their faith (can't you always *see faith?*), promptly forgave him of his sins, which promptly produced evil thoughts in the minds of some in the room.

Why were the thoughts evil? Was it because they were the same kind of thoughts as those expressed in Matt. 12:22-37? (Are "careless" thoughts of the nature of "evil" thoughts? Would a careless thought be one that did not treat all the known facts honestly and draw a right conclusion from those facts?)

The claims of Jesus were ever for His deity (deity = God). He never claimed to be less than deity, despite some who teach the contrary. This incident (the men rightly thought that only God can forgive sins) and many others (as the one next in John 5) show clearly that He meant for His auditors to draw this conclusion. He never corrected the Jews here, in John 5:17ff., or elsewhere, when they accused Him of claiming deity. He came to bear witness to the truth. So how could He do any differently?

The men might have wondered what forgiving sin would do for the paralytic, but they rightly thought that the only one who could forgive sin was God. The problem in their thinking: Jesus was God, but they would not accept it. So they in thought accused Jesus of blasphemy. That was false and thus wrong, which made the thought evil.

Considering their evil thoughts, Jesus gave them a reason for changing their thinking. Instead of acting in a sphere where no verification could be done, He restored the man's health, and told him to depart. He intended for the men to draw this conclusion: if I can do this healing (which only God could do), I can also forgive his sin, which only God could do. Many were made to think at least, though they were undecided about the paradoxes (Greek word which is translated as 'strange things'—Lk. 5:26) they had seen that day.

Matthew's call is not surprising in some respects. Jesus was well known in the area, and the people most

likely to hear would be those like Matthew the tax collector in his public occupation. Jesus needed his life in a bigger collecting business than material things, and Levi the tax collector was a thing of the past.

One can but admire his next move: he made a great feast and invited all his friends (the ones known as sinners). What better way to introduce them to Jesus, his new-found Master? Jesus demands both a new life and a new leaf! Conversion ought to shake the rugs, throw open the windows and change the linen.

But some could not share in the beginnings of a new way of life. They asked the right question and received a startling answer. Tradition taught that righteous people did not countenance such as Levi. Well, God did not go by tradition—so He did. It would have been better to be sick and have known it, than be sick and not have known it. Such was the case with those who asked about Jesus and His associations. They got an answer like none before, about sickness and mercy, wine and wineskins.

For us, the response of Jesus is clear. He was the bridegroom, and life was to be enjoyed, but under a new system. He came to move the law system out (Matt. 5:17-18) and usher in a new faith system. Jesus was far too big for tradition—and the faith system could not be contained in a law container. A double blunder would be done if the gospel was “tacked” on to the law like a patch, for both would be ruined. A new book was needed, not an amendment!

Consider the wine and wineskins (remember, the wine is the important thing!): it would be dumb to put unfermented wine in old, stretched wineskins. The calf or goat's hide when “green” would stretch with the fermenting wine. But dry, stretched skins would not. So . . . one puts newly-made, unfermented wine in “green” skins, so when the wine expands in the fermentation

process, the skins will s-t-r-e-t-c-h, and both wine and skins will be saved. That is an illustration of why Jesus did not put the gospel in a law container. It just would not work—then or now.

Law, whether expressed as in the Mosaic system or not, can only condemn. It never has the power to make a man righteous. So Paul in Romans 3:20; 4:13-15; 5:20; 7:7; Gal. 3:21-22. Life is not in law, but in the Son, Col. 3:4; I Jn. 5:11-12.

Romans (as Hebrews) is wholly devoted to the thesis that the Mosaic law, though the best expression of God's will to be found, yet was unable to produce rightness with God. The problem was that it was nullified by the flesh, Rom. 8:3, and simply could do aught but condemn. So God used it and other means to introduce us to Christ, Gal. 3:23ff. When we rightly understand that, historically speaking, we have all sinned at a place and time, we will surely echo the cry of Paul in Rom. 7:24, which is the only truthful statement anyone can make under any law system. Add Christ and the cry is changed to "no condemnation," as in Rom. 8:1. With this understanding, we can sincerely say to Christ, "I have always wanted to meet you," and thank God that He has used the law to "lead" us to Jesus.

Jesus was too big to be confined by tradition. He came to fulfill the law (the faith system validates law, Rom. 3:31) and bring a "new way of living," Heb. 10:20. Yet man has never actually lived, unless he lived by faith (see Heb. 2:4; Rom. 1:17). Bible history then is a picture frame for the faithful who had life only through faith, not law (see Heb. 2:4; Rom. 4:1ff.; and Heb. 10:18—13:25. This last passage is quite clear in presenting the "better way: faith.")

So then, one may fast or not, as desired—the gospel does not demand fasting. One may tithe or not, or attend

MAP NO. 3—SECOND YEAR OF MINISTRY

1. Jerusalem—Second Passover, lame man healed at pool, Jn. 5
2. Near Capernaum—plucking grain on Sabbath—heals withered arm in Synagogue on Sabbath, controversy, Mt. 12; Mk. 2-3; Lk. 6
3. Near Capernaum—names 12 disciples, Mk. 3; Lk. 6.
4. Unknown Mountain—Sermon on the Mount, Mt. 5-6-7; Lk. 6; heals centurion's servant, Mt. 8; Lk. 7
5. Nain—Raises widow's dead son, Lk. 7
6. Capernaum—Question from John the Baptist—forgives sinful woman in house of Pharisee, Mt. 11; Lk. 7
7. Galilean tour—Charge of league with Satan—sign of Jonah given—Mother anxious for him—sermon in parables—high cost of discipleship, Mt. 12-13; Mk. 3-4; Lk. 8-9
8. Sea of Galilee—still's tempest, Mt. 8; Mk. 4; Lk. 8
9. Gergesa—Casts demons into swine, Mt. 8; Mk. 5; Lk. 8
10. Capernaum—Heals woman with issue of blood—Raises Jairus' daughter from dead, Mt. 9; Mk. 5; Lk. 8
11. Nazareth—last recorded visit, could not do miracles, unbelief, Mt. 13; Mk. 6
12. Bethsaida Julius—third Passover night—feeding of 5000, Mt. 14; Mk. 6; Lk. 9; Jn. 6

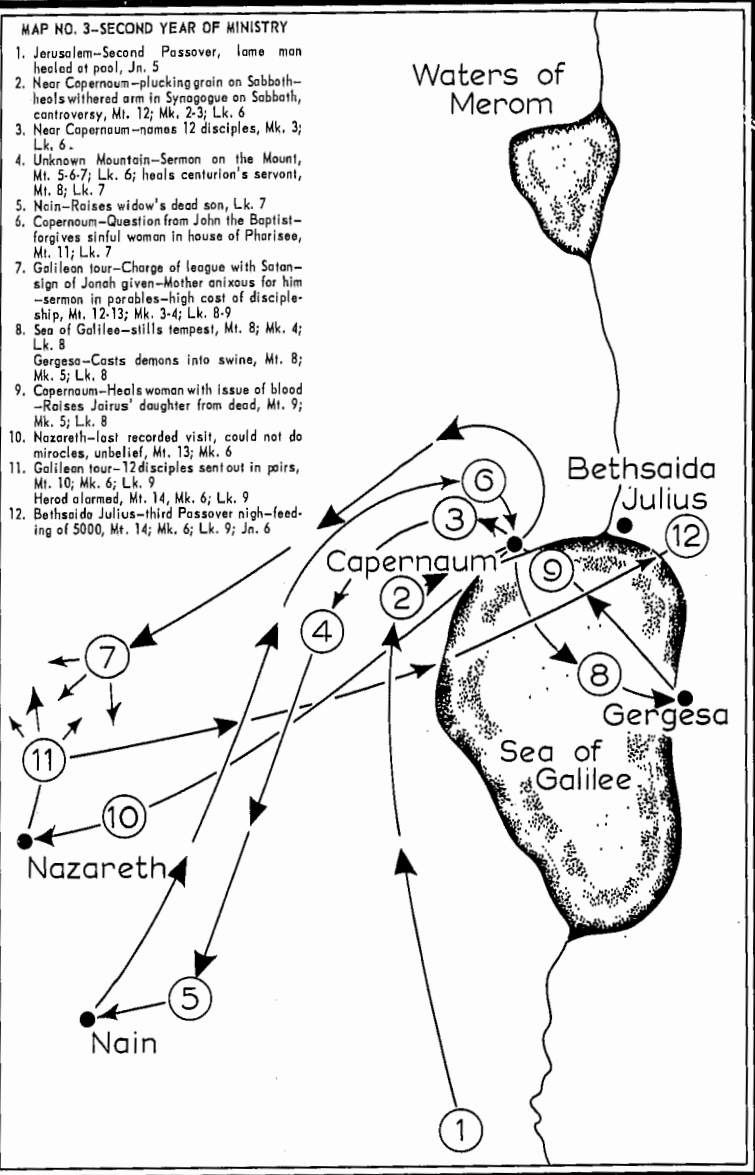



CEDARS OF LEBANON

SECOND YEAR MINISTRY

or not, as far as having any law goes. The gospel does not so demand. Yet, motivated by love, rather than law, how can a Christian, when he comes to maturity in thinking, want to do aught but the most he can? Christianity is wrapped up in love, Col. 3:14, and needs only a suggestion from God to supply direction. Yea, God's every wish is our command.

SECOND YEAR OF MINISTRY

Jerusalem—John 5:1-47

Historically speaking, the feast of John 5 presents several things of importance and most important are the claims of Jesus of Nazareth about His life's history. The problem of what feast this is comprises one other item. What the law of the Sabbath was is another (for which discussion see the next section).

Division about whether this feast is a Passover, or some other feast, is always present. Some feel that it is not, and others argue as forcefully it was. Needless to say, it is not possible to decisively say from this point in time. For those who wish detailed arguments about it, consider Hendrickson, Vol. I, pages 187-189; Wescott, pages 92-94; Turner and Mantey, pages 129, 173-174; Bernard, pages XVII-XX; and Andrews, 189-198. Both external evidence from texts, versions, church fathers and all else that can be cited leaves the issue in doubt. Internal evidence causes some to argue vigorously for a Passover (generally on the basis of too short a time period for the recorded events in Galilee), and others (like Bernard in the old International Critical Commentary) to despair and resort to transposition of Chapters 5 and 6.

Since it devolves upon individual opinion, we choose a Passover. This choice gives another year to the length of Jesus' ministry, and makes it somewhat over 3 years.

The order of Passovers and dates is then John 2:13, A.D. 27; John 4, A.D. 28; John 6:4, A.D. 29; and John 12:1—ch. 20, A.D. 30.

Assuming the sequence of events in John as given, it is rather doubtful that John's account would allow this to be the feast of Pentecost following the Passover of John 2:13. Consider the fact that 4:35 seemingly points to a harvest time. One would hardly call 50 days (from Passover Jn. 2, to Pentecost Jn. 4) 4 months. If the mention of time in 4:35 refers to the beginning of harvest of which normally first-fruits are offered at Passover, then at least 8 months have elapsed since John 2:13. Eight months would take us to a point of time beyond even the Feast of Tabernacles, which comes six months after Passover. If the feast of John 6:4 is the next succeeding Passover from John 2:13, then the only feasts left are those of Dedication in December and Purim in March. Purim was observed in the local synagogue, with Esther being read, and did not necessitate attendance in Jerusalem. The feast of Dedication in late December did not require attendance in Jerusalem or elsewhere. If Jesus were in Galilee in late November (end of John 4), it at least seems doubtful if He would go back to Jerusalem for this feast, necessity not requiring it. The law required attendance at Passover, Pentecost and Tabernacle of all male Jews as per Exodus 23:14-17 and Deut. 16:16-17. Thus as stated we choose the next succeeding Passover (in A.D. 28) from John 2:13 (A.D. 27) as the one in question. If it were the Pentecost feast following (in the year A.D. 28) it would make no essential difference in the total picture.

The other problem in this text is that of the pools in Jerusalem. The better reading in the text is that of Bethzatha, though there is some support for either Bethsaida or Bethesda. Its location is likewise in doubt, with most of the evidence pointing to a pool in the NE part.

SECOND YEAR MINISTRY

The first name, Bethzatha, was applied in a modified form to the portion of the city north of the temple area, and between Stephen's Gate and Herod's Gate. The suggested pool is located near an ancient church building called St. Anne. It has five porches (or arcades) and an ancient fresco with one of the walls showing an angel troubling the pool water. The people (v. 7) thought that the pool water moved or something of the sort, and attributed healing properties to it. The reader will note that God does not say that such occurred (either the water acting curiously or any healings) but simply records the belief. Some have thought that a pool such as the Gihon pool, which has an intermittent action, must be the pool. But aside from the facts already stated, it is rather difficult from our point of time to decide what pool it was, or if the pool is even known, and if known (as the suggested pool) that it had an intermittent flow, whether it seems possible now or not.

Most readers will be aware of the fact that verses 3b-4 are not a part of John's original text. These were doubtless inserted by later copyists to provide a basis for the belief of the people as stated in verse 7. For some who read this, and are unaware of textual problems such as this one, we will remark that we are only interested in what God inspired men (such as the apostle John) to write. We want to know what was written by these men because such writings are alone inspired. Anything added (or taken away) is not inspired, and not God's Word. This position is a must for the Bible believer, for if we believe and accept what uninspired men wrote as being inspired, to that extent we will misteach or disobey God (since to believe is to teach and/or do what is believed).

"Do you wish to be healed?" To such an apparently naive question (why else would a cripple of 38 years be there?) the man answers firmly, if not directly, "yes."

Jesus gives the command and the man goes home whole. Questioned about such apparent law-breaking as pallet-carrying on the Sabbath, he justifies himself by citing Jesus' command. The stage is set for a sermon on His own deity by Jesus. He makes the affirmation in v. 17 about His action and His relationship to God. When the Jews draw the conclusion He is claiming equality with God in v. 18, He stamps His approval on their good logic and preaches a sermon to enforce it.

This Sabbath healing is one of at least seven recorded. They are as follows: 1) A man with a demon, Mk. 1; Lk. 4, 2) Peter's mother-in-law, Matt. 8; Mk. 1; Lk. 4, 3) the paralytic of our text, 4) the man with the right hand withered, Matt. 12; Mk. 3; Lk. 6, 5) the blind man in John 9, 6) a woman bowed double, Lk. 13, and 7) a man with dropsy, Lk. 14.

The sermon teaches that Jesus is unique with God as the giver of physical and spiritual life, the judge and jury of all mankind, and the subject of various witnesses, specifically 1) John the Immerser, vv. 33-35, 2) His works, v. 36, 3) the Father Himself, v. 37, 4) the Scriptures themselves, vv. 38-40, 5) and Moses, vv. 45-57. We believe the word translated "search" in vs. 39 is best understood as a statement of Jesus about what the men were doing, rather than a command to study the Scriptures. He warns the men that they had a poor relationship with God when they refused God's glory displayed in Christ and accepted man's glory, and that their own "fairhaired" boy, even Moses, would accuse them (the Greek word means bring charges against as a district attorney would) of rejecting Him.

Galilee (1) & (2) & (3)—*Matt.* 12:1-21;

Mk. 2:23—3:12; *Lk.* 6:1-11

The Sabbath was a problem in N.T. times, and is yet.

SECOND YEAR MINISTRY

We have those in our time who would make the day something other than what God intended, and the same was true in the ministry of Jesus. The Lord never said so, but it almost seems at times that He intentionally did things on Saturday just to gain attention, to the end that teaching could be done. He tried often to show how God meant for the people to observe the Sabbath in contrast to the ways they did observe it.

Jesus gave five reasons why the Pharisees were wrong in their interpretation (He also corrected false ideas in John 4:22ff.—a good challenge for us to check *our* ideas) about the Sabbath. He declared the disciples broke no law of God, and were “not guilty” in what they were doing by citing a case 1) in history; David, not guilty because of necessity, 2) of exemption: the priests, who actually *worked* harder Saturday than any other day, 3) from prophecy: the correct attitude will do or undo any action, 4) the real intent of the laws about it: it was not meant to be a burden, but a blessing for man’s use, 5) and the real relationship of Jesus to the day. He knew how He meant for the day to be kept, even when He gave it to Moses.

We definitely feel that Jesus had every right to show what constituted keeping the Sabbath laws. After all, if He were equal with God, He was directly responsible for all the O.T., and the Sabbath laws are included. There was really no bad thing in the law, but the interpretation by the Jews was certainly bad. They had falsely taught what constituted “work” on the Sabbath, or, in another sense, how God meant for the day to be kept holy. Granted that God meant for no work to be done on that day, but who defined “work”? Jesus showed that it is lawful to do good on the Sabbath, as in Matt. 12:9-14. So “doing” things did not necessarily constitute breaking the rule against work.

Perhaps this incident can help us see one of the problems with laws: they must be clarified as to what is meant, etc. One law almost demands three others to explain it. Jesus finally came to give us an example of the perfect law-keeper. We are firmly persuaded that He Who came to fulfill all righteousness, Who did no sin, Who was made under the law, Who was tempted in all ways as we yet without sinning, did not break any one of God's laws. To do so would constitute sin. Nor are we persuaded that He put Himself above them, just so He would not have to observe them. What sort of example would that have been for His disciples? or for us? The incident in Matthew 17:24-27 is cited by some to show that Jesus considered Himself free from keeping the law. But the text does not say He intended to avoid paying the tax—just that the men asked Peter whether He paid it or not. You will note that Peter and the questioners were all aware of the law, and as aware of Jesus' relationship to payment of the tax. You may also note that Jesus paid it (though He used it to show Who He really was) to not be a cause of stumbling. Please reread Luke 17:1-2 in this light. Some teach that Jesus did not go up to the Passover at the end of the second year of ministry. But the text does not state that fact. Our conclusion from the above remarks is that He did go, and invariably observed all laws, while exhorting others to do likewise (note the command to the leper in Matthew 8). One teaches by practice quite as much as by speech.

How much are you worth? God taught His disciples that a poor exchange would take place if a man gave his soul for the whole world, Matt. 16:24-26. But men have always degraded themselves, and others like themselves, Romans 1:18-32. (The exclamation of Jesus that a man is worth more than any sheep is intended for those listening—men who had no idea of the worth of a soul.) The

SECOND YEAR MINISTRY

people in our own time who teach that man is simply the result of impersonal matter plus time plus chance are no different. History is replete with men (and women) who so thought, and translated such thinking into mass murder. If such an idea is really true, then why does it matter if bombs are dropped on large cities? or if abortion is allowed? or we "shoot up" with heroin? Does it matter at all if we are only matter? However, if Jesus is right, and man is worth more than a sheep, then everything that is important is wrapped up on each man's individual personality—the unseen world is the real, abiding world, II Cor. 4:16-18. Each man and woman is then worth exactly as much, no more or less, than Jesus, Who died for each. How much, think ye, is that?

Aware of the action being planned by the Pharisees and Herodians, all hard of heart, Jesus left the synagogue, and went into the surrounding area. The gospels record eleven times when Jesus withdrew for some reason, as rest, prayer, or safety. But hardness of heart was not a malady of all, so many people came from everywhere, and Jesus helped them. Seven centuries earlier, God had prophesied through Isaiah that Jesus would come and serve. The promise was kept, and so very wonderfully.

So intense were the seekers that the disciples feared for His life, and kept a boat ready for His safety. And no wonder, for He healed all who came.

As you read the text in Matthew, verses 18-21, meditate upon the description of His ministry. So tender, careful, compassionate with all who came with honest and good hearts. The concern in dealing with each life, some so broken, almost gone, even as the bruised reed and smoldering lamp about out of oil, was so often expressed in His ministry. When Jesus comes, the tempter's power is broken, tears are banished, darkness departs, life begins—for all. Jews, Gentiles, whoever, can hope in the name

that is above every name, and find life in the only name under heaven whereby salvation can be obtained, Acts 4:11-12.

Galilee was not large, as we think of size, being only about thirty miles east to west, and fifty miles north to south. The tour of Jesus in these recent months, plus all the miracles, had generated wide interest. The ministry was growing, and help was now needed. Among those many interested followers Jesus had twelve men who were now ready to be enrolled full time in His peripatetic school.

Galilee (4)—Mk. 3:13-19; Lk. 6:12-16

Prayer through the night was followed by the choice of these twelve, seven of whom we have already known for over a year as being disciples. Now they are to be aided by five others. We include a list to show these. Luke gives two men different names in his accounts in Luke 6 and Acts 1 which we note. Otherwise, all four lists, Matt. 10, Mk. 3, Lk. 6, Acts 1, are essentially the same. Other names are found in various texts, and we give these.

Matthew 10, and Mark 3

Simon Peter	Thomas
Andrew, his brother	Matthew
James, son of Zebedee	James, son of Alphaeus
John, his brother	Thaddaeus
Philip	Simon the Cananaean
Bartholomew	Judas Iscariot

Bartholomew is a patronymic, and is thus like the King James rendering Bar-jona (Matt. 16). The prefix "bar" means "son of" which makes Simon (Peter) the son of John. The word Bartholomew means "son of Tolmai." He likely had another name, and is often identified with Nathanael of John 1. The full name would then be Nathanael Bar Tolmai. Thomas is also identified as the "twin"

SECOND YEAR MINISTRY

(King James—"Didymus") in John 20:24. Matthew is identified by himself as one of the hated tax collectors (called publicans in the King James); and also as Levi the son of Alphaeus (Mark 2:14, Luke 5:27). James is also called "the Less" in Mark 15:40. The other James is identified as "son of Alphaeus." The name "Alphaeus" was a very common name, and in its Hebrew form would be spelled Alphi or Clephi, but as Chalphai in Arimaeon. So, sometimes it is seen in our New Testament in the form Cleophas, or Clopas. We note a Mary, the wife of Clopas in John 19:25 at the cross with other women. (See the chart of these under the discussion of the crucifixion.) It is doubtful if the Cleopas in Luke 24:18 is the same name (and person) as Cleophas (Clopas). It is hard to decide if Mary is the mother of any of the apostles. Thaddaeus is likely the Judas, son of James, Lk. 6. The appellation "the Zealot" is given by Luke in Chapter 6 and Acts 1 for Simon the Cananaean.

Galilee (5)—Matt. 5:1—7:29; Lk. 6:17-49

Having chosen the twelve men who would share with Him the establishment of a new order, Eph. 2:20, Jesus details principles of the disciple's life. The principles are not meant for the world to keep, but the disciple. It is not surprising then that countless men have looked at it and despaired, or declared it "unchristian" and unworkable. Jesus enunciates ideals that are attainable—only in Him. The sermon is not gospel but law. It shows us how things were meant to be, and must be. The state of the one in Christ, the life expected of one in Christ, the relationship of Jesus to the O. T. law (as an expression of God's eternal principles) and the relationship thus expressed of the disciple to Jesus: all are clearly taught in this discourse.

Consider the verses containing the beatitudes. They are certainly other-worldly. The world would not consider happiness from the positions enumerated in these verses. But it all depends on one's point of view—if God is in the picture as in Rom. 8:28, then the abiding state of the disciple is happiness regardless. Read James 1:2-4; I Pet. 4:12-16; Acts 5:41-42; 16:19-34; Matt. 10:24-32 in this light. Please do not miss the tense of the verb: it is present, thus what the disciple now possesses in Christ (See John 3:36a; Rom. 5:1 and 8:37). You should then consider the verses to teach that happiness is a given state, and that state is in Christ. We assume the parallel passage in Luke is but the negative of these verses.

As these verses present what the disciple has through Christ, so vv. 13-16 present what the disciple is to the world. *Salt*: the negative function of preserving from decay, a life secretly, quietly but surely changing the status quo. *Light*: the positive expression of illumination and consequent elimination of darkness. Light's function is shining. So we must. All the darkness in the world can not really put out the smallest candle.

Jesus now explains and clarifies His relationship to the O. T. law. He gave it, and now He both 1) replaces it and 2) explains it. The disciples are treated to the real meaning of certain commandments expressed in the O. T. law, and enjoined to pay strict attention to what Jesus says, else a total collapse of life will result. There are no alternatives—only absolutes (as in 5:19-20), either in the elaboration of the commands or our response to such.

Attitudes about others is the subject of 5:21-26. Nullifying attitudes such as hatred must go. Instead, *we* make every effort to have right(eous) relationships with others, Rom. 14:18. We may undo all we attempt to do in worship to God otherwise, as in 6:14-15.

We will consider marriage and divorce in detail under

point # 64 (4), but consider this: Jesus clearly teaches the real intent of the seventh commandment, and especially as it relates to the tenth commandment. Adultery is uncontrolled desire, which translates into lack of self-control. The disciple who is a man is to add self-control to his faith, II Pet. 1:3-11. Thus he has *no excuse* for such sin. He may blame "Eve" or "Bathsheba" for "their" ungodliness but it is his lack of self-control that is at fault. Men need to hear Nathan say again, "You are the man!" Note that the *excision* is to be done on the one lusting, not the one about whom a man lusts. Who can have a *pure heart* if not the one who wills it? The woman's body was created by God, and is considered *very good*, Gen. 1:31. All vice is but perverted virtue. The body has proper use—but the lustful man can misuse his body (such as his eyes, mind) as well as the woman hers. Do you have any excuse for your sin? Consider II Cor. 10:5 and Titus 1:15 in this regard. Your own will is the key.

5:33-37 speaks of an honesty basic to any Christian. The only reason oaths are necessary is because of evil, as expressed by dishonesty. Are you as good as your word? Expressed contracts are often needful, that all parties concerned may know what is expected of each, but the oath to bind each party to the agreement should not be necessary, at least for the Christian. Laws may require oaths, and this passage does not forbid them if such is true—Jesus only states the "law" for the Christian, what he should do and be in regard to others. He must realize that all he does and says is ultimately related to God.

5:38-42 expresses the idea of retaliation (whether it be physical or judicial) in the Christian life. A parallel passage is Rom. 12:19-21; and Peter reminds us of Jesus in I Pet. 2:21-23. The verse from Ex. 21:24 is in a section (21:18—22:17) that deals with retaliation and restitution in various phases of life. Lev. 21:18-21 and Deut. 19:1-

21 are related texts. The disciple is not to be vindictive. The particular verse in question expressed the *limit* that could be demanded by one wronged. But the one wronged did not need to demand the limit. He could forgive and forget. What do you consider the normal course of action should be for the disciple? Should he be vindictive?

Jesus speaks of the "mile." Any Roman soldier who was in need of help could force anyone around to aid him if circumstances demanded it. But Jesus says that the disciple was not only to go the first mile gladly, but the second mile willingly! How utterly astounding to Jewish ears, for the Romans were despised. But that is the "undertone" of this whole sermon: how God really expects people to live. Question: have you ever considered the "second mile" as your privilege? Do you make the most of any opportunity that comes your way?

5:43-48 concerns being unworldly. We must be "other-worldly" or like God is. God treats all alike in some respects, and we are to be like Him. God treats all alike (even being kind to the ungrateful and selfish, Lk. 6:35), though not from ignorance or indifference. It is just that love always wants to go the second mile. The contrast in our text is between disciples and others (defined as non-disciples). What do ye more than others? Others are going to hell, you know. We are to be different, not in degree but in kind.

Note that the O.T. did not teach that one was to hate enemies. That was an addition by humans. What additions to God's laws do you make to keep from doing those laws? Read again Matt. 15:3-9.

You should be aware of the fact that 6:1-18 is taking up the topic of a godly life which can be expressed in many ways, three of which are mentioned: charity (in our sense of the word), prayer, and fasting. Those of you who use the King James Version must consider that the

SECOND YEAR MINISTRY

word *alms* in verse 1 is a mistranslation. The Greek word is translated as 'righteousness' in such passages as ch. 5:20 and Rom. 1:17. It should be here. Sometimes the word piety is used to express a life of right living. Keep in mind that this sermon is for the disciple of Jesus. As disciples, we do not need or desire the praise of men, but of God. Motives for doing things is the crux of this passage. Why do you help the needy? pray? fast? If it is for aught but the kingdom, it is eternally useless. God will reward us in the next life (the word 'openly' in v. 4, 6, and 18 is not justified at all) if our motives are pure. Pure motives are to be expressed by us in all we do, whether in word or deed, because we are Christ's, Col. 3:17.

God gives many undeserving people sun, rain, life, crops, health, etc. He also helps those who do deserve such things. The disciple can do likewise by means of charitable acts, whether through some agency or not. The important thing: love is the motive, not honor from men.

Prayer is a most wonderful thing—if done for the right reason. If done to receive the praise of men, it is damning. The only motive for prayer is to communicate with God. There may be secondary effects of such, even the praise of men, but such must never be the reason for prayer. You will note that the model for prayer that Jesus gives centers around God, and the disciple's relationship to Him. It is simple, though inclusive. Verbosity is so easily confused with piety, and fluency with devotion! These things are not necessarily equal.

Jesus teaches that in the first two words the disciple has settled things between himself and God, this material world, and others in it. *Our Father* is only for the disciple, who is attempting to 1) live a life honoring (hallowing) God through 2) doing His will here on earth and 3) at-

tempting to get the rest of the people in the world to do it.

The only three states in life anyone can have are past, present and future. The present state is now, with the past gone, the material needs of today are of concern. We need not ask for tomorrow's bread (needs) until tomorrow. Only today's is of importance (note the amplification of this idea in verses 19-34). God will take care, on any given day, of the needs thereof. We need but fully trust Him. So very often we do not even know what we need or do not need. We often ask wrongly, James 4:1-4. To not be unduly anxious over that which does not exist (tomorrow) is our daily thought, Phil. 4:4-7. Too often our present is robbed of its rightful joy because we either carry the past into it, or borrow from a future possibility that is actually non-existent. When you pray, then, do this: 1) pray as a child of God, 2) mean what you pray about your life and God's will. Assume that God hears and answers (the Bible teaches that both are true) your prayers. Now—if He has answered your prayer, even in a way you did not ask, believe that He has brought about the present circumstances in your life exactly as you need them. What is happening is God's will for you. If He knows best, then you should rejoice in what is happening, since it is but the answer to your prayers. Did you read Phil. 4:4 (not 6 or 7, but verse 4)? It is not an easy lesson to learn, admittedly, but it can be done. Paul had *to learn* to be content in any circumstance, Phil. 4:10-13.

Fasting is not demanded of the disciple. It can be practiced if desired. The O. T. only commanded one day of fasting, the day of Atonement. Jewish teachers had various traditions, as in Lk. 18:12, but none were given by God. To make matters worse, many did it to be seen by men for their praise. That motivation undoes all one

SECOND YEAR MINISTRY

can do. Therefore, when a disciple fasts he is to look normal! Fasting is for self only.

6:19-34 points up one basic fact: all the disciple does must be with one goal: pleasing God. Anything that divides such an "aim" is of evil. And such a person, double-minded, is unstable in all ways, James 1:5-8. Jesus, in Heb. 10:7, and Paul, in Phil. 3:12-14, set the right examples. Any other life is a relatively "faithless" life. Worldly care is an evidence of unbelief.

Perhaps 7:1 has been misapplied about as many times as any Bible verse. The verse has nothing to do with the judgment God will render upon everyone, as Acts 17:31 and Heb. 9:27 have in mind. Jesus is forbidding only one thing: a criticism of others that is ungodly. You should note that verse 5 specifically states that help for others is to be given, after the disciple has considered his own deficiency. Appraisal of people is a daily task: how else will we obey verse 6, or II Cor. 6:14ff., just to mention two of many verses? The verse could be translated as "Quit criticising unjustly, for you will be criticised the same way." Note that Romans 2:1 does not forbid judgment of others at all, but rather condemns a person for not applying the same principles of judgment on self.

Please note that Jesus expects us to help others worthy of it; withhold help from those who do not, v. 6. Both involve judgment. Judgment is expected in verses 13-14, and verses 15-20, and verses 21-23, and verses 24-27. What Jesus wants is honest judgment.

Now—how to accomplish it? The answer: ask, seek, knock. God will help us. In fact, much help from God is ours already. It's in the Bible. Will you read Eph. 4:11-16, esp. v. 13; and II Timothy 3:16-17 in this light? Note Heb. 5:11-14 here, too.

7:12 is the climax of 7:1-11. However, it is a basic moral principle as old as God Himself. Consider yourself,

and your needs. Sometimes, if you are honest, you need to be loved, helped, encouraged, etc. Other times you need to be denied, spanked, reprovéd, etc. How do you then apply this principle, based on your own determination of need, to the man who is wronged in 5:21-26? How about the woman in 5:27-31 (or girls, the man in the same text)? If you are able to have your way in life, what would you like for others to mean by their 'yes' or 'no'? What do you mean by yours? How about the text in 5:38-42: suppose you were a person who was greedy, and were always "living off" your friends or relatives. What should love really do: give or deny? Love does not do any evil, Rom. 13:8-10. Would evil possibly be the giving of something, or the withholding of something? Suppose you were a drug addict: what would be good (an act of love) rather than evil—to give you another dose, or refuse to do so? How do you think love acts? Does love ever do wrong? (Did you define 'wrong' from God's absolutes or the world's?) How does 7:12 apply to 7:1-11?

7:13-28 is the conclusion of the sermon. Jesus' authority and way of life are implicit in it. His way is the narrow way, all other ways are from teachers who are blind (Lk. 6:39-40). Consider carefully where a man's doctrine will take you. The fruit a teacher produces is good or bad depending on the ultimate result. Jesus as a teacher will lead you to life. One may teach others Jesus' teaching and they can have life. But false doctrines abound, and the end results of such must be judged. Following the wrong teacher will produce the result in 7:21-23. Lives based on false teaching will collapse totally, vv. 26-27.

Two ways, two foundations, two rewards, neither less nor more. The whole sermon is based on these precepts. Indeed, Jesus' whole life and teaching carry these ideas.

SECOND YEAR MINISTRY

Your life could end on a "minor" note if you take the wrong way, build on the wrong foundation, and gain the wrong reward. Do you really want your house (life) to come crashing down around your ears?

Galilee (6)—Matt. 8:5-13; Lk. 7:1-10

Humanness was a part of Jesus' makeup, though just how we do not know. It is seen when tiredness comes, grief and anger are present, companionship is desired, or when He marvels as is the response to the faith of the centurion. How tragic that Israel (His own people) could not present to Him a faith that matched it.

The centurion's faith is seen in his expression concerning authority. Faith is trust. Trust obeys authority, whether reason for the command is completely understood or not. The Gentile sinner simply shamed the Jewish people, over whom he ruled, by his complete trust in the authority of Jesus to do whatever Jesus wanted (expressed by his belief in Jesus' ability to heal his servant without bothering to go where the servant was). And, as he expected, the servant was healed. Our prayer probably needs to be, as was the disciples', "Lord help us increase our faith," Lk. 17:5. Our centurion, like the one at the cross, Cornelius in Acts 10 and Julius in Acts 27, is a challenge to mimic.

Nain—Luke 7:11-17

Nain is only mentioned in Luke 7:11. It is doubtful if much would be remembered about it by anyone. However, for one widow, name unknown, Jesus made the town live forever in happy memory. Located probably where the modern town of Nein is, Nain was surrounded by Old Testament towns of note. Endor, I Samuel 27, was about two miles west, Shunem about five miles south-

west, II Kings 4, and Jezreel was about seven miles in a southerly direction. Jezreel was the scene of Naboth's tragedy, I Kings 21, the last encampment of King Saul before his death, I Samuel 29, the location where Joram was slain by Jehu, and where wicked Jezebel became dog food, II Kings 9.

Women were supposedly objects of care and concern, even in Old Testament times, at least for the Jews. But practice rarely matched God's expectation. Often the widow who could not find another husband was reduced to beggary or worse. It is heartwarming then to read that Jesus returned a means of livelihood to such a woman. How she must have marveled that Jesus came her way. Though funerals often lasted over one day in respect to mourning (see John 11), yet burial was quite often the day of death. So it was rather unusual that such a meeting took place.

Though touching a dead person meant ceremonial defilement, Numbers 19:11-22, for seven days, we note that when Jesus came, life came. We wonder if Jesus became unclean in touching the beir, or if in touching it, the dead was not dead?

Capernaum—Matt. 11:2-19; Lk. 7:18-35, 36-50

Did you ever try to put a square peg in a round hole so that the two fit? John had some of the same problems we do, and recognized them. He had painted a picture of the 'coming one' but Jesus did not seem to fit it. So he began to doubt—whether himself, or Jesus we know not. Viewing the picture he painted in Matt. 3:11-12, we will also find it hard to match Jesus to it. Many others tried to push Jesus one way or another (as Jesus teaches in our text, v. 12) to make Him fit. Prophets in all times sought to harmonize what they said to what they

SECOND YEAR MINISTRY

knew (see I Peter 1:10-11; and consider Acts 2:39 to Acts 10:1ff.). But so very often prejudice ruled, and Jesus described this under the figure of children who will not to be pleased. People found reasons for refusing John (and thus disobeyed God) and likewise for Jesus (and thus crucified the Lord of glory). A question for you, dear reader: what are your reasons for disobeying God's will?

Perhaps John's continued imprisonment at Machaerus (per Josephus), located on the east side of the Dead Sea, and the realization that Jesus was making no attempt to free him (not to mention the fact that Jesus' ministry did not conform to John's description) resulted in this question. It may be that John thought Jesus had forgotten him (he had been there some time—perhaps 3-4 months, see Mt. 4:13) and just took this method of reminding Jesus of it. These questions would be better with answers, but we have none for them. One thing is for certain: If John could have heard what Jesus said about him, his heart would have glowed.

We do not know his reaction to the statements of Jesus, but we can speculate. John died upholding God's truth, which he had always taught. He was not the type of character that could be bent with any passing breeze of doctrine, or who stood in fear of kings as do the people in a king's court. Is it too much to say that meditation on the work of Jesus reassured this last and perhaps greatest of all (other than his Master) the prophets?

Capernaum (2)—Matt. 11:20-30

In contrast to John's life of trust, the people in Chorazin, Bethsaida and Capernaum were mostly distrustful, and ultimately disowned by God. How wicked they must have been to have Jesus say that even the people of

Sodom would have less accountability (that is, we would more readily excuse them than the people in Jesus' day if we could see both as God does) than they. Opportunity means responsibility—and these cities had much of each because the majority of Jesus' mighty works was done in their streets and houses.

Wisdom is not always godly. Some reject God's wisdom, and the result is arrogance, and a second rejection—by God. We daily must bring every thought into subjection to Jesus and then we will be wise in reality. The wise and understanding are only such when they subject all to God. God only laughs at men who exalt their wisdom and attainments, Psalms 2:1-4. To be laughed at by God is not funny—we had better learn that fear of God is the beginning point of wisdom.

Revealed religion is the message of Matt. 11:27. Grasp also the unique relationship of Jesus (see John 1:18, 14:9) to God the Father. Now if the claim of v. 27 is true, then the words of verses 28-30 naturally follow. This section claims quite as much for Jesus as the oft-cited passage in Matt. 28:18. Jesus had the right to offer what He did and satisfy the taker.

Isaiah 57:20-21 depicts the state of people in sin. Just as accurately drawn is the conclusion of Peter in Acts 15:10 concerning the Jews particularly. Sometimes men were responsible for some of the ceaseless turmoil of people under law, as noted by Jesus in Mt. 23:4.

The poignant cry was for relief! But a yoke is relief? To a knowledgeable person, a yoke smacked of toil, submission . . . anything but relief. And a yoke that did not fit meant shoulder sores, and heightened anguish. The gospel story is made the more vivid by paradoxes. Here is one of those.

Jesus gives rest to all who come. We are free in Christ, Gal. 5:1, to do as we please. Jesus makes the yoke

SECOND YEAR MINISTRY

easy (the Greek word implies agreeable, pleasant, well-fitting), just right for us. Yea, Jesus took (our) burden, and left us with a song. All this . . . and heaven, too.

Capernaum (3)—*Luke* 7:36-50

“Simon: I have something to say to you” (and the rest of us better listen in!). Simon thought that Jesus was not really what He claimed, since He allowed “this . . . sinner” to touch Him. One’s smug complacency and self-sufficiency often shut the door to blessings, though. Jesus had to teach that His mission was to sinners and not to righteous (cf. Matt. 9:12-14), as well as the fact that the attitude of the debtor to the one owed makes the essential difference. Faith is the required attitude, love is the motivated response to forgiveness. Faith makes whole, and love tells the story. Simon’s attitude was like that of those in Lk. 11:52. The woman (not either Mary Magdalene or the Mary in John 12:1ff.) displayed in life what Simon perhaps never dreamed of, or if so, never allowed himself to dream again. It is no wonder that the common people flocked to Jesus, and compassion was forthcoming. Anyone not of the Pharisees seemingly was considered less than equal, and often much less. Note the comments of the Pharisees about Matthew’s guests, Matt. 9:11, and the remark of the Pharisees and scribes in Luke 15:1-2. (See Peter’s evaluation of himself in Luke 5:8.) You also note what they thought about Jesus in John 9:16, and the blind man in 9:34 (note the blind man’s expression in v. 31). These references show that the thought of Simon about the woman, v. 39, does not mean necessarily that she was a harlot, as some suggest. She may simply have been of low estate or one despised by Pharisees. A Jewish saying of the time had the true rabbi thanking God daily that he was not 1) a Gentile,

2) a commoner, or 3) a woman. It is worth remembering that Christianity does more to make men realize common equality of all (Acts 17:26 and Romans 3:29-30), and elevate the position of womanhood than any other system known to man.

Second Galilean Tour (1), (2), (3)—*Matt.* 12:22-45, 46-50; *Mk.* 3:19b-30, 31-35; *Lk.* 8:19-21

Conduct reveals character! A good tree bears good fruit, but how can one speak good when one is evil? Jesus states the reason why He was accused of being allied with Satan in spite of the obvious fact that He was daily working against him. He well points out that Satan is not so stupid that he would undo his own work. Conclusion: Jesus and Satan were at loggerheads! A second plain fact was also evident by the forced eviction of Satan's agents: the one evicting was greater than the one evicted. Pity for the accusers of Jesus would be in order except for the fact that they had little or no excuse for such poor reasoning. Jesus will teach in *Matt.* 13 that people in Israel were willful sinners, especially in rejecting Him.

Words are then not to be uttered lightly. They express what we are inside. They are one area in which we will be held responsible. A tree's fruit reveals its makeup. Our expression does likewise. This is why Jesus speaks of sin—the men recognized a notable deed had been done, but refused to acknowledge the real agency causing it, *Mk.* 3:30. And no one can be neutral in this area.

Continual distortion of evident facts is a sign of an evil make-up. In respect to Jesus, the Holy Spirit's testimony about Him is disregarded, and labeled false. Such action is sin. Maintaining this state means sin is constant,

and not able to be forgiven. Repentance is a change of mind (the antecedent of repentance is faith. Faith presupposes knowledge of God's will and our relationship to that will by which we will find ourselves to be sinners.) resulting in a change of conduct. Only by repentance is forgiveness possible. Continual sinning clearly indicates a life in opposition to the will of God, since God does not desire that such a state be true. Repentance must become a part of such a life, or God cannot forgive (see II Chron. 7:14 in this light).

The preceding paragraph is an introduction to a discussion about the sin of which Jesus speaks, commonly referred to as the unpardonable sin. We must understand the word "pardon" as being exactly equal to the word "forgiveness" in this context. Thus, when we speak of sin which is unpardonable, we mean sin which is unforgiveable. We believe the Bible teaches 1) that a person not in Christ has no sin forgiven him. Many passages plainly teach that forgiveness is only in Jesus. 2) The corollary to this statement is that a person in Christ has every sin forgiven. We have peace, Rom. 5:1, no condemnation, Rom. 8:1, are made righteous, II Cor. 5:21, in Christ, because the sinner is brought nigh by and receives forgiveness (pardon) through His blood, Eph. 2:13; I John 1:7; which all results in each such person possessing eternal life (we have it, present possession) according to John 3:36. Conversely, the person not in Christ has no peace, Isaiah 57:20-21; Eph. 2:14, nor mercy, I Pet. 2:10, nor hope, Eph. 2:12, for we are without God, Eph. 2:12, and separated from Christ, Eph. 2:12. Therefore, God's wrath abides (now) on us, John 3:36.

This position leads to this conclusion: In Christ, any and all sins are forgiven, but out of Christ any and all sins are not forgiven. We believe that this position is the starting point, the universal, the major premise from which

all else is reckoned. A conclusion from this position: Any and all sins are/are not forgivable (pardonable) depending absolutely and directly upon one's relationship to Jesus. Hence, any sin is or could be unforgivable, depending on who you are, Christian or non-Christian. Any sin is or can be forgiven, if we are in Christ.

We then posit this fact: The Bible only treats two states in life: in Christ or not in Christ. If we either do not become Christian or cease being such, this state definitely keeps us from receiving any pardon. The all-important state in life is to be in Jesus for life is in the Son, I John 5:11-12. We get in Christ by a decision of our will, and that is the way we stay there. We get out by a decision of our will, and that is the way we stay there. Therefore, a continuing decision to do every day the will of God is habitual for the Christian. This person may sin during the day, but that is not the aim or intent habitually. If sin occurs, forgiveness is sought, repentance occurs, and pardon is then ours. We rather than willing to habitually sin will to habitually do right. Sin is abhorred, and Christ is loved instead. Sin will then be not habit-forming. For us to live will be for Christ to live. This is the Christian!

The Christian state in life is then a decided (willed) habit, a continual willing to be in Christ regardless of any evil that occurs in our life. If we sin, we recognize it, confess it, (which involves repentance of it) and keep on keeping on in Christ. To state it again, we make a decision for life when we choose Christ, and nothing that happens is going to change our minds about that decision. In this state, we remain justified to God. Not that we do not sin—I John 1:8-9 assumes that we do sin—but we act as a child of God should about it: repent, etc. Do you think that Paul never sinned after he became a Christian? Did he cease being Christian when he did so? If

SECOND YEAR MINISTRY

not, why not? Did Peter never sin after he became a part of Christ? Did he cease being Christian when he did so? If not, why not? If you have answered the first questions with "no" and the second questions likewise, how do you think they remained in Christ? Did they repent, and confess such sin, do you think? If so, could you not do the same, and the identical results accrue to you as to them?

Any other position than the one just stated puts a person under a law system, and not under grace. If each time we sin, we cease being Christian until that sin is forgiven, and we remain in Christ only until we again sin, we do not live under a system of grace, but law. If such were true, how could Paul ever call the people in the church at Corinth "saints" when they were such sinners? Was Peter out of Christ when Paul had to correct him in Antioch (see Gal. 2) ?

The secret then of the Christian life is aptly stated by Paul in Philippians 3:13-14. It is called the life of faith, which includes Abraham with his sin, Jacob with his, Paul and Peter with theirs. We are justified through faith, and we possess peace (which is essentially a word describing a right relationship with God, not necessarily the absence of conflict or trouble in one's life) through Christ who is the means of our justification and reconciliation, Rom. 5:1; 4:25; 5:11.

Now for the statement of Jesus in our text. From the foregoing discussion we believe that Jesus is spelling out the state of the men in our text who were asserting that He was of the devil. They were rejecting the testimony of the miracle as to the personage of Jesus. Such testimony rejected means that these men had refused the only hope they had. They were definitely not doing God's will. In fact, Jesus and John were both rejected by some, and in so doing, they refused God's will for them, Luke

7:29-30. We believe this because the Bible teaches that Jesus was and is the only way to have forgiveness of sins.

The relationship of the Holy Spirit to Jesus has an important bearing here. We believe the Bible teaches that Jesus' earthly life was under the direction of the Holy Spirit, as Luke 4:1, 14 would indicate. The Holy Spirit was also the means through which the apostles and others wrote the New Testament, John 16:7-14, etc. Now, if we reject the Holy Spirit's testimony to Christ, we essentially reject Christ. We hence cast aside the only means of forgiveness man has. Such refusal puts us into the state where no sins are pardoned. As long as we continue in that state, we have no forgiveness. Hebrews 10:26 teaches that fact, as do other passages. The men opposing Jesus were either in such state or of such a bent of will that they were going to be there. This is why Jesus charges them in vv. 33-37 to rightly judge, and not be prejudiced against Him. He points out in vv. 38-42 that their rejection of Him was worse than they thought.

Others with less testimony accepted the means to forgiveness, or simply realized God's presence in a life (the men of Nineveh, the queen of Sheba) and a greater than either Jonah or Solomon stood in their presence. The peril of continuing in the state of mind these men possessed is then pointed out in vv. 43-45. The devil will have the life at last that rejects the One Who is life.

This is the state in life of the one described in Hebrews 6:4-6. The continued set of mind against Jesus means the person in question cannot be brought to a state of repentance. For those of you who do not read Greek, infinitives and participles in the present tense describe a habitual state. The Greek participles (conveying the ideas of crucifying Christ and contemptuously holding Him up to public display) in verse 6 are both in the present tense, depicting the fact that the person in view wills for the

SECOND YEAR MINISTRY

state to continue. These form the key to understanding the "impossible" idea presented in verse 4. If one leaves Christ, the state in which pardon is available, and refuses to return, (such refusal results in futility for any renewal efforts), quite obviously repentance is not willed. Continuance of this willed state will provide the devil with an empty house to occupy. We can not remain neutral in life, Matt. 12:30. Consider then the peril of the empty life, not filled with Christ! My (only) hope is in Christ. Where is yours?

Summarizing the discussion we posit:

- 1) —Any and all sin can be forgiven (pardoned) if a person is in Christ. Otherwise, no sin of any kind is forgiven (pardoned). The key then is being in Christ.
- 2) —Repentance expressed in confession, a request for forgiveness and a change of conduct is prerequisite to forgiveness.
- 3) —The person in Christ is always justified since he has fulfilled the condition in # 2. He will habitually be in this frame of mind.
- 4) —Habitual abode in Christ is sufficient to present one spotless before the throne of God regardless of any particular sin committed.
- 5) —Habitual sinning, indicating a change of mind in reference to Christ, will put one into a state where forgiveness is not possible (since only in Christ is forgiveness available).

Comment has already been made about the brothers and sisters of Jesus. Sufficient is the remark that Jesus pinpoints the necessity of willing to become related to and joint-heirs with Him.

Second Galilean Tour (4) & (5)—*Matt.* 13:1-52;
8:18-22; *Mk.* 4:1-34; *Lk.* 8:4-18; 9:57-62

Utilizing the natural amphitheatre formed by the lake-shore, Jesus presents the coming kingdom by means of parables, each of which illuminates a given aspect of the kingdom. Used frequently by other Jewish teachers, and in Jewish writings, Jesus capitalizes upon this method to draw interest in the kingdom. Most people enjoy teaching that is plain, neither too simple nor too hard. Style often discourages listening, and any good teacher endeavors to keep interest at a high level. A parable disarms rather than immediately alienating. A story is a seed bed for new truth. The enduring worth of these is well illustrated in a man's experience in World War II. Harold Dixon and two other men crashed into the Pacific Ocean. A thousand miles from land, left with nothing but a raft eight feet by four feet, they began to drift, and thirty-four days they drifted until land appeared. During those days, Dixon remembered some of these stories he had been taught during childhood in Bible School. He recounts that every evening he would tell one story. It served to snap them out of their depressed mood, and stimulate lively discussion. By such as this, they retained their sanity. A story is indeed a seed bed for new and exciting ideas. Parabolic teaching will, if the lesson is caught, be easily remembered. Jesus implies that their worth, as instruments of teaching, lies in their being a test of character, since they reveal seekers for truth. They also help clarify an obscure point by relating it to something known and understood. The common sight of a sower, a woman kneading bread, a draught of fish—all can be used to teach.

What if earth
Be but the shadow of Heaven, and things therein
Each to the other like, more than on earth is thought?
(Milton, *Paradise Lost*.)

The lakeside parables form the first major occasion of teaching with this means. In subsequent days, other aspects of the kingdom will be spotlighted by these "earthly stories."

The reader will soon note that Matthew and Luke record the major part of the parables. Mark has some. John has a few or none, depending upon definition. This last thought also determines just how many parables are given. Some list 27, 30, 34 and up to 50.

Interpretation of them is a major problem, since a few agree upon what is to be considered as mere drapery, or intended for comparison. The only sure interpretation is by the author, whether Jesus or someone else. A second important point is that parables may clarify issues, but should not be used for establishing doctrine. A parable, as any figure of speech, is intended only to illustrate.

A parable then is a means of light, and not intended for a mystery. Jesus intended to challenge people into thinking—people of His day. He doubtless did not give them so clever people twenty centuries later could finally discern the point, while all who had gone before could not do so.

The eight parables uttered on this occasion aptly illustrate facts of the kingdom, and its subjects. The sower and the soil—each an important part of farm life, and of the kingdom. The features of this parable would be easily imagined—the man going out from the village to a hillside with its varied soil; here shallow, there rich and deep. Thorns, weeds, a bridle path, birds attendant. Such is the audience almost any time the gospel is preached. Ex-

perience will teach this to the preacher. Yet God has so made man, and the gospel that though the start is small (the mustard seed, the leaven) and the growth rather seen than understood (Mark's seed), yet the result is sometimes one hundred fold, whether of the kingdom or individually. So the sower must not despair.

Hearing is decisive of results, too! So Jesus pinpoints the other side: how each person determines what his life will be. We can let worldly cares, desire for riches and multifarious other things turn us into no-account soil. Likewise, we can put all we have into procurement of the best over the better (the pearl, and the hid treasure), secure in the knowledge that such is right. We may not know how evil arrived, but rather than spend time seeking to find that answer, we will let our light shine, and leave that problem in the good hands of Jesus (the lamp, and the tares) while we sow seed. In the end of the age, the Son of man, even Jesus the coming Judge, Acts 17:30, 31, will separate good from bad, and justice will triumph. A final parting shot: a wise householder will learn to value what is true and good, whether old or new. The old is not bad because it is old, for it was new once. The new is not inherently good because it is new. Wisdom will treat both with due respect. So the kingdom and its inclusion in one's life is a job life-long, at once good news and a surprise package as yet unopened.

The kingdom is free to all, yet it demands all from any. We then can not be an impulsive disciple, or a casual one, nor have a divided mind about it. Conversely, resolve, abiding interest and a single eye (cf. Matt. 6:22-23) should be the possession of every disciple. The men who offered excuses in substitute for obedience got what they deserved—a reprimand. Jesus describes Himself as the "Son of man" (over eighty times in the Gospels) and He knew that these men could do differently. True

SECOND YEAR MINISTRY

greatness does not consist in possessions but in person, not collateral but character. Respect for obligations is mandatory; but we must have the right priorities. Yea: first things first! Nothing and no one must have a hold upon us that prohibits service to Christ. Any farm boy surely knows that a straight furrow is not possible if one is *always* looking back (the force of the Greek participle) rather than concentrating ahead (cf. Philippians 3:13-14). We must look ahead, which in this context means to put Christ first—always.

Sea of Galilee—Matt. 8:23-27; Mk. 4:35-41;
Lk. 8:22-25

“The sea is the shape of a harp—so we will call it Chinnereth,” Num. 34:11; Deut. 3:17; Josh. 13:27; or “Chinneroth” Josh. 12:3, I Kings 15:20. Perhaps this is the way the people gave what we know as the Sea of Galilee a name. A town by this name was on the north-west shore of the sea, Josh. 19:35. Also known as the Sea of Gennesaret, Lk. 5:1, and of Tiberias, John 6:1, 21:1, the Sea of Galilee is located some sixty miles north of Jerusalem on the Jordan River. Some 685 feet below sea level, with hills on all sides, it has a warm climate that produces some tropical vegetation, such as fig trees, palms, etc. Jewish rabbis are reported to have said that God had created seven seas, but the Sea of Gennesaret was His delight.

With Mt. Hermon (visible to the north) and the high country to the north of it, and other physical features like its below-sea-level depth, cold air currents from the northern plateaus sweep down to the small lake (about thirteen miles long and eight miles wide—though varying dimensions are given for it) and meet warm air coming up from the Jordan below (which is still falling,

dropping some 590 feet more to the Dead Sea) causing sudden violent storms such as our text describes (see also Matt: 14).

Around the lake were many cities of importance in Jesus' day—Capernaum, Chorazin, Bethsaida, on the north and to the west of the Jordan; while Magdala and Tiberias farther down on the west side (the latter built by Herod Antipater in honor of the Roman ruler) completed this section. Bethsaida Julias (the capital of Philip the tetrarch, and named for a daughter of Augustus named Julia) on the east side of the Jordan near the north entrance, and Gergesa complete the cities of note on the east side in Jesus' day.

Unbelief brings fear, doubt and despair. The cry of "We are perishing, do you not care, Master?" was a cry of unbelief. It was the idea of the disciples, not of Jesus, that they were perishing. Jesus gave the command to cross the sea, and the disciples, and the other people in their own boats, should have trusted Him for a safe arrival. But the element of distrust produces the wrong sort of question to God. Rightly, they were rebuked. Their faith had long since grabbed a life preserver and flung itself overboard. Oh men of little faith!

For us—is there any essential difference in their faith-lapse and our lives? Do we fear that God can not keep us if He sends us somewhere? whether in a boat or 180 feet on the land below the boat?

Gergesa—Matt. 8:28—9:1; Mk. 5:1-20; Lk. 8:26-39

This city has always had problems! Among others is the fact that its name is variously spelled Gergesa, Gerasa, or sometimes changed to Gadara; and that two of its citizens (so I assume) were demon-possessed. The last factor doubtless was rather embarrassing to the towns-

people, since they could not forge chains strong enough to hold them (or at least one of the two). Perhaps the man was so demonized that they were afraid to attempt to chain him after several failures. The men had left the town, and were dwelling in some tombs near it.

Jesus met these two men, one of whom was apparently the more outstanding, and the demons so controlled the one man that at times he spoke and then they spoke. First worshipping Jesus, and then giving vent to the question of the demons, the men were pitiable to behold. At Jesus' command, the men were released of the demons. At their request (their utterance in v. 28a is the same idea, in almost identical Greek expressions, as Jesus expressed to His mother in John 2:4) and with Jesus' permission, the demons entered into some two thousand swine (the text offers no reason why they asked this nor why Jesus permitted them to so do) nearby and caused them to rush violently down a steep cliff and perish in the Sea of Galilee. The men were left in their right mind, and sent to the cities around the Decapolis (which meant ten cities) area including Gergesa. Man's extremity is truly God's opportunity.

"Please . . . leave."—and Jesus left the area of Gergesa, recrossing the sea to Capernaum. He will return to the Decapolis area not many months hence, but now is not the time to minister there.

Capernaum—*Matt.* 9:18-26; *Mk.* 5:21-43;
Lk. 8:40-56

Numberless songs have found their impulse from the Bible, and not a few sayings. One of the last finds its source in our text. The "hem of the garment" is this one. The woman of our text, her living spent and the affliction unchecked, had despaired of being healed. But

as God would have it, an entirely unrelated circumstance occurred, and the chance of a lifetime materialized. Faith reached out and found the power of God could do what man could not. Need we say more?

Man can do many things today—we marvel at transplanted hearts, and then pay them scant notice. We sit glued to the sight of men walking on the moon, and then cease even to bother with the next launch. But death still offers a challenge. It seems to have always been so.

Jairus, his daughter at the point of death, thought Jesus was the last and ultimate solution to his problem. How right he was! But one can imagine his annoyed expression as the woman caused Jesus to stop and waste precious time, for the twelve-year old was near death. If he were annoyed, it surely turned to grief when a messenger from his house informed him that his efforts were in vain. The girl was dead—but dead to whom?

Jesus quickly assured him that the situation was not changed—and proved it. The mourners were treated to drama in real life: they had never seen it this way before (and so laughed at Jesus, when He told them their tears were vain). But Jairus laughed last and best. Mourning as the world does is not needed when Jesus is around, I Thess. 4:13-18. He had remarked in John 5:28 that those whom we call dead would hear His voice and come forth. The son of the widow at Nain and this young girl are evidence that they (whom we call dead) are quite alive to God. (Further remarks about the "dead" will be found in the discussion under point 72 (6), as well as John 11.)

Though success and consequent fame were evident nearly everywhere in Jesus' ministry, as seen in the healing of the two blind men and the dumb demoniac at the last of Matt. 9, some did not share in these. The reason: they did not wish it to be so.

Nazareth—Matt. 13:53-58; Mk. 6:1-6

The immediate text chronicles probably the final visit of Jesus in His boyhood home. He had appeared here before (point # 23) but with little success, barely escaping with His life. This visit is hardly an improvement. They again found early associations of Jesus a problem for their acceptance of Him. Like the people of John 6, they refused to consider all the facts involved, and so found Jesus a "hard saying." He could do but few miracles because both opportunity and reason to do so were absent. Jesus had earlier marveled at the faith of the centurion, Matt. 8:5-13, (who would have been considered a Gentile sinner by people of Nazareth) and now He marvels at the unbelief of home town people. How true the proverb was about honor. Familiarity breeds contempt sometimes, and the gospel writers record two events where it was so (here and John 4:43-45). Yet one can not help but wonder why they disbelieved so greatly.

We have remarked under point # 7 about Jesus' brothers and sisters. We again remind you that the context identifies Jesus with Mary, and so too with the four men mentioned as His brothers. Perhaps James is most prominent (Acts 15; and perhaps I Cor. 15:8, and likely the author of James), though Judas may be Jude, author of the book Jude. We remark in passing that the word "carpenter" is not the only possible translation of the Greek Word. It also describes any worker of metal, stone or wood.

*Third Galilean Tour—Matt. 9:35-38; 10:1-42;
Mk. 6:7-13; Lk. 9:1-6*

The harvest: great—the harvesters: few. The close of chapter nine in Matthew recorded this observation by Jesus. The lost sheep of Israel were scattered, having no

shepherd, and in need of compassion from someone. Jesus was that one. He taught the disciples, and also us to pray to the harvest Lord . . . and then plan to answer that prayer. It was as if He said, "You are the finger of God . . . don't you see?" Jesus never taught that we should expect some other person to do what God has for us to do. Practicing what He preached, the twelve were called together, given both instructions and the necessary power, and then sent out among those scattered sheep.

The tenth chapter of Matthew is valuable for us today, especially in respect to any mission endeavor or prospective mission worker. In it Jesus points out 1) the urgent need to both preach and respond to preaching. The kingdom of Heaven was at hand then. The church and our association with it bear the same imperative today. He reminds the disciples that the evangelist must not waste time with those who do not wish to hear. Other people (in places akin to Macedonia) are waiting for someone to come. 2) The Lord will adequately provide. Therefore, make no more provision than absolutely necessary. Every laborer is worth the support he gets, and people properly taught this will respond. He teaches that they received without charge, so give without charge. Yet God would provide for them, and they were to expect Him to do so through those to whom they preached. We are then, as servants of the most high God, neither to trust self only, nor leave everything up to God. He is our partner, true, but He has no mind but ours to use in planning what is needed. 3) We must preach the good news regardless of the consequences. Again, the immense cost of rejecting God's message is spelled out. The gospel is only good news if accepted! Resistance is the norm, He says, even to family groups. But He did not come to make everyone feel righteous and needing nothing (Cf. Rev. 3:14ff.). Often He will warn His disciples of

SECOND YEAR MINISTRY

coming opposition (note John 15:18—16:4). Our relationship to Him will guarantee opposition for us. Therefore: "gird your armor on, stand firm everyone." Yet, "be not dismayed what e'er betide, God will take care of you." We are not greater than our Master. Besides, God sees and knows all. He is the One Who will rightly judge. If we remain true, we shall be saved. Only those who fail to fear God will be sorry, for He will cast them into hell. 4) The high cost of serving Him. But as just remarked, the cost is greater for refusing to serve Him. We must therefore get our priorities right, even about our immediate family. It is a case of losing to find, of keeping by giving, and living by dying. With this sort of attitude, everything we do is of eternal consequence. Jesus often points out the little things of importance: the idle word, Matt. 12:37, the widow's gift, Mk. 12, the one pound, Lk. 19:20, the hair on your head, and the fallen sparrow. Here: the cup of cold water. Life is made up of years, but years of minutes. If we are not trustworthy in smaller things. . . (Lk. 16:10)?

Is it not interesting that Jesus always tries to lift our eyes to God—through the mundane things of life—never to treat the world and all that is in it as if it were not there. But neither to think that it is all there is, either. Both positions are damning. The disciple will use all wisely, whether body, or material possessions, or family. It is of interest that Jesus teaches that the only enduring thing is the relationship to Him. In this light think about your attachment to family, the blood ties you have. Then consider what Jesus teaches in this text, 10:34-37, and in Matt. 12:46-50. Does He ever tell you that you are to love blood relatives more than you are to love relatives through Christ? Which relationship will last longest? The old saying that "blood is thicker than water" has never been true and still is not true, nor will it be. Christian

baptism puts a person into an eternal relationship, unless the person severs it himself. May we set our minds on things above (that is: get the important things in life straight!). Consider how much the New Testament teaches us about how to consider and treat Christian brothers and sisters. Compare this with the teaching spent on blood relationships. The Bible teaches us to keep both in their place. The same Greek words are used of the relationships in Christ, as are used for fleshly ties. But the spiritual ties are the only ones eternal in nature. Hence, we will do well to consider earthly relationships in the light of the New Testament.

*Third Galilean Tour—Matt. 14:1-12;
Mk. 6:14-29; Lk. 9:7-9*

Our attention is drawn now to one of the tragedies of life: the killing of God's messenger because he told the truth. The warning of Jesus in Matt. 10 about whom to fear (see also Lk. 12:1ff.) is ever timely. John told the truth to Herod Antipater (Antipas) and it ultimately cost him his physical life. How much better though to lose what we can not keep to gain what we can not lose!

The killing of John through the subtleness of Herodias, the shamelessness of Salome, and the spinelessness of Herod has always brought to mind facts like 1) God's Word is the same for all, and 2) God expects His messengers to trust Him, not regardless of the evidence, but regardless of the consequences. How brightly John shines in this regard! No marvel that Jesus said, "None greater has been born by woman."

John was not the first nor the last man to lose his head over a dance. History is made ugly oftentimes by just such scenes as our text records. The Greek word describing the dance of Salome means she stooped to the

SECOND YEAR MINISTRY

level of a common prostitute. Herod, with no backbone and doubtless drunken, was no match for this nor the clever Herodias. Modern day parallels abound. As this is written, the current Reader's Digest contains the story of a French government representative who through a woman fell into the clutches of the Russian government. How sad! We only comment about Herod that he should have broken an oath that would cause him to do wrong. No oath should be made or kept that ultimately proves sinful. Such is our thinking also about Jephthah's vow in Judges 11:29-40. Regardless of what actually occurred in respect to his daughter, he should have changed his vow if it finally conflicted with a law of God. We should make no vows except as we recognize that they ultimately relate to God (Matt. 5:33-37; James 5:12).

Bethsaida Julias—Matt. 14:13-23b; Mk. 6:30-46;
Lk. 9:10-17; Jn. 6:1-17

“. . . to a lonely place apart.” John had been killed and when Jesus was informed of it, He desired solitude. He had feelings too, and as before remarked, was not less human than we. Nor was He less divine, we believe, because of them. Mark's account relates that the withdrawal was also for the sake of the disciples. They had been on tour and having returned needed the rest and quietness. They needed to “come apart . . . before they came apart.” Even God knows we have physical limitations. Relaxation may be done many ways, but the physical body demands it somehow. Perhaps this is why God created us to do the natural thing called sleep. We may not have enough sense to relax any other way. However, we conclude that to our own Master we stand or not. May each of us consider our own life's stewardship in this matter. We must not condemn others whose desire to

NEW TESTAMENT HISTORY: THE CHRIST

serve God perhaps surpasses ours, but whose ideas about relaxation are, to us, different at best or seemingly wasteful at worst.

Yet life goes on and, as in Phoenicia not long after, Jesus could not be hid. The year's labors, the preaching tour, the death of John the favorite of the people: all combined to result in a great throng following Christ.

The large crowd was doubtless composed of many from nearby areas. But Passover time was near (note John 6:4; and Mark's "green grass" in verse 39) and many pilgrims on their way to Jerusalem may have been part of the crowd. Perhaps some were there (as is implied in John 6:15) because since John was dead they now turned to Jesus as their hope for a leader against Rome. Remember that one of Jesus' disciples was a former member of the Zealots, a group actively working for overthrow of Roman rule. One can only marvel that a riot did not occur. Probably the action of Jesus in sending His disciples away (were they for the crowning of Jesus?) before the dismissal of the crowds kept such from taking place.

Jesus, the disciples, and the large throng were apparently on the high hills east of the Sea of Galilee near the area known as Bashan. This area was cattle country especially, and cities were not so numerous. Thus we read that when it came time for the evening meal, the scarcity of food was a problem. Or at least it was to the disciples. Jesus had no problem for He had already anticipated the next major incident. He asks Philip about bread for the group. Philip quickly reckons that the crowd is so great that two hundred day's wages (see Matt. 20:2) would not suffice to buy even enough bread so that everyone would have some to eat. The only thing sufficient was Jesus. He caused the people to sit down in orderly groups (which helps us see how the size of the

SECOND YEAR MINISTRY

multitude was known to some extent) so that they might be fed. The blessing of the food was followed by the miraculous feast. We think it is rather superficial to suggest that Jesus shamed the crowd into bringing out their own lunches and sharing with others by telling them about the little boy's example. In fact, such explanation amounts to unbelief. The text plainly declares (as does Matt. 16:5-12) that Jesus miraculously fed the crowd here, and in Perea some three to four months later. The warning Jesus gives in Matt. 16 about the leaven of false teachers needs *our* attention.

The multitude fed, the disciples were ordered to "pick up the pieces." Jesus had *kept giving* (the meaning of the Greek word) bread to the disciples until all were satisfied. Now the remnants were not to be wasted. The broken pieces left amounted to a total equal to twelve baskets. These particular baskets were the size used to carry Levitically-clean food. The baskets in the feeding of the 4,000 were larger. In fact, they would hold a man! For one of these was Paul's means of escape in Damascus (Acts 9:25).

The disciples, their task of clean-up accomplished, immediately were told to get in the boat and leave. Then Jesus dismissed the crowds Himself and struck off into the hills avoiding the rush—the rush, that is, to force Him to become their king. Satan does not miss a trick, does he? How tempting to have said "yes" to the unspoken (?) request of the crowd. They had no shepherd at all now since John was dead. Would Jesus become their leader? Consider the thing from the viewpoint of the crowd. John had been their spokesman. Many were disciples of John, and had been for sometime. John was even thought to be like the Messiah, if not the Messiah, Lk. 3. Now he was dead. But Jesus was also popular, had many disciples, and could work miracles (such as the one in our

text) coupled with the ability to even raise dead people. What more could you want, if you were in their place? The "great society" was but an affirmative answer away!

THIRD YEAR OF MINISTRY

RETIREMENTS AND TRAVEL WITH THE TWELVE (about 6 months)

Sea of Galilee—Matt. 14:22-33; Mk. 6:45-52;
Jn. 6:15-21

Toward morning Jesus returned to the disciples for they had a problem. The tempestuous wind and sea had completely thwarted their efforts (though they were probably used to boats) to arrive at land. Walking toward them on the water, Jesus brought to light again their unbelief. They had been *tormented* by the wind and waves (the Greek word conveys the idea of tortured like slaves) but at the sight of Jesus they became completely undone. So afraid were they that He had to speak to them that their fear might be overcome.

Peter provides the example of a man whose mind is divided. James reminds us that such a man is unstable in all his ways, 1:6-8. The point is that indecision in one area of life if continually practiced soon permeates all our thought processes, and we become as a tossed wave: subject to the elements about us, and no longer in control of self. Jesus gave Peter the privilege of walking on water, but Peter could not keep his mind as it was when he first stepped overboard. So he began to take on some water, and shouted for help. Jesus pointed out that his doubt caused the water to give way under his feet. Mark records that the hard hearts of them all caused their fear. They simply refused to admit what the feeding of the 5,000 really proved about Jesus!

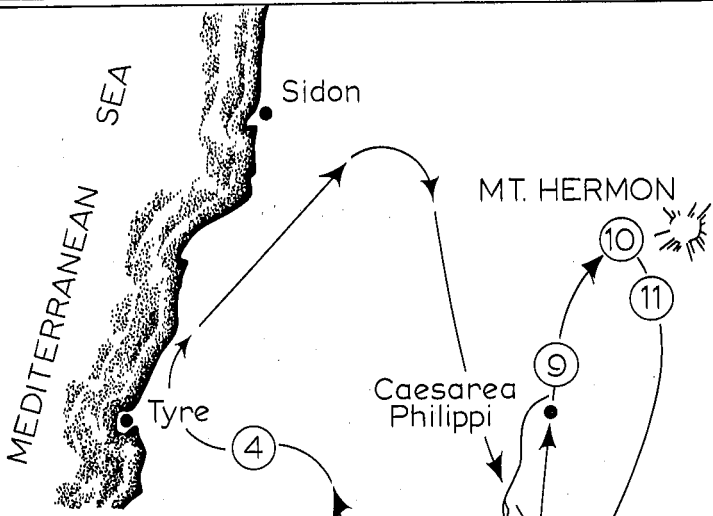

MAP NO. 4—LATER GALILEAN MINISTRY
THIRD YEAR

1. Bethsaida Julius—walks on water of Sea—still's tempest, Mt. 14; Mk. 6; Jn. 6
2. Plain of Genezaret—many miracles, Mt. 14; Mk. 6
3. Capernaum—Sermon on Bread of Life—questions on washings, Mt. 15; Mk. 7; Jn. 6
4. Phoenicia—Retires—heals Syro—Phoenician woman's daughter, Mt. 15; Mk. 7
5. Decapolis—preaches and heals, Mt. 15; Mk. 7
6. Near Sea of Galilee—feeding of 4000, Mt. 15; Mk. 8
7. Magadan—Jews demand sign—no sign given but of Jonah, Mt. 15; Mk. 8
8. Crossing Sea—warns against leaven of Jewish leaders, Mt. 16; Mk. 8
9. Caesarea Philippi—Jesus's identity, Peter's confession, Jesus predicts His death, Mt. 16; Mk. 8; Lk. 9
10. High Mountain (Hermon?)—The Transfiguration, Mt. 17; Mk. 9; Lk. 9
11. Heals epileptic boy, Mt. 17; Mk. 9; Lk. 9
12. Capernaum—Peter & temple tax, Mt. 17; Discussion as to who is greatest, Mt. 18; Mk. 9; Lk. 9
13. Unknown miracle worker, Mk. 9; Lk. 9; Discussion of stumbling blocks, forgiveness; Mt. 18; Mk. 9; Advice of His brethren, Jn. 7
13. Samaria—on way to Feast of Tabernacles Samaritans reject Jesus—Sons of Thunder would call down fire from heaven, Lk. 9

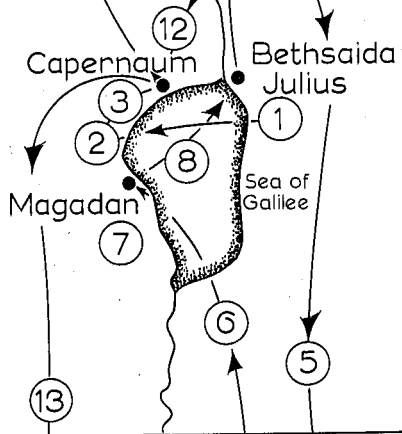



MOUNT CARMEL

THIRD YEAR MINISTRY

What does this episode mean to you? If Jesus bid you to come to Him on water, would you grab a life preserver, just in case? Let us learn at least these lessons from the feeding and the events surrounding it: 1) Jesus is not limited necessarily by our inadequacy. 2) He has absolute dominion over all things. 3) Our troubles are often caused by our unbelief. Doubt brings disaster! 4) Unwillingness to accept the facts about Jesus and grow in faith causes hearts to become hard. The disciples refused to acknowledge Jesus' deity displayed in the miracle. God can and does feed many more than that every day, but the *way He did it* that one day should have produced different results than it did in the disciples' lives.

Gennesaret—Matt. 14:34-36; Mk. 6:53-56

This land is not named by John, but we assume the text in 6:21 speaks of the same place as Matt. 14:34, Mk. 6:53. Jesus constantly helped those who honestly desired it, and it was so here. Mark's account seemingly describes a general tour, though of what length we know not. However, this small area around the northwest side of the Sea of Galilee would bring them close to Magadan, and other small towns there, as well as upper Galilee in general. Perhaps this would get the immediate attention of the people in that area who would already know Jesus.

Capernaum (1)—Jn. 6:22-71

John's gospel has provided some information about Jesus' ministry since the feeding of the 5,000, which was the first time that all four accounts treated the same subject. Generally the Synoptics describe ministry in Galilee or other places than Jerusalem and Judea.. Luke's account though will soon take us back to Judea, and will also describe (almost exclusively in respect to the other three

accounts, chapters 10-18) work done there and in Perea. John's account centers in Judea, with chapters 12-20 given over to events in the last week around Jerusalem. The sixth chapter gives us the only lengthy account by John of ministry away from Judea prior to Jesus' death. It recounts for us a major address in Capernaum by Jesus, and the subsequent unfavorable reaction of most of His auditors. As John 5 had recorded the rejection of Jesus by people in Judea, so John 6 recorded a rejection of Jesus in Galilee.

The second year of ministry was marked by great crowds, and is often called the year of popularity. This third year of ministry is often termed the year of opposition. We would generally agree with these thoughts. However, let us point out that *opposition* has already been noticed several times, even beginning in John 2. Luke's account will definitely describe *large crowds* following Jesus. The text in 12:1 says the people were so "thick" they stepped on one another. Consider also the "large multitudes" of 14:25. This six months of private ministry and/or the whole year was anything but private, and/or without following. Within the six months (possibly three or four) Jesus will feed 4,000 men plus women and children. Jesus always had people around Him who wanted to hear.

Everyone who heard was not always pleased however. We might label Chapter 6 of John, "The Mistaken Search." The people thought the teaching was hard, v. 60. So disappointed in what Jesus said were they that they left Him. Only the disciples (expressed in Peter's response) considered that the teaching of Jesus was the word of life. Jesus called Himself the "Bread of Life." As you read this sermon, ask yourself, "For what do I hunger? Is it after righteousness?" (Matt. 5:16). Those who turned away hungered only for physical things. I John 2:17 says

THIRD YEAR MINISTRY

that things of a material nature perish with the using. As you finish reading it, ask in first person, "Will I also go away?" How we need to heed Jesus' injunction in v. 27, "Quit laboring for the things that perish. Instead, labor for the eternal things."

Works cannot save us! Repeatedly one reads that in current commentaries. Ephesians 2:8-10 is quickly cited to prove the affirmation. If one asks those who proclaim this to define "work" they will often reply with "baptism is a work; therefore, baptism cannot save." Other than citing I Peter 3:21 which affirms rather plain that baptism does save (who am I to argue with an inspired apostle?), we agree in part. However if asked if they think that faith saves, almost invariably the answer is affirmative. In this light read verses 28-29 of John 6. The people asked what they could do to "work God's works." Jesus Himself replied that the work God wants is to believe in Jesus. The conclusion seems clear enough, and Jesus says it, that faith is a work. Now, does faith save or does it not? Do works save or do they not? Peter remarks in Acts 2:41 that we are to save ourselves. Paul writes in Gal. 5:6 that faith works. We have never read a text where God calls baptism a work. Have you? We must speak as the Bible speaks, or we speak in error.

The feeding of 5,000 plus might have sent people away with full stomachs, but it seemingly did as little for their thinking as it did for the disciples'. These people wanted to see a sign! As if feeding a multitude were not a sign! They wanted to see something done like Moses giving the manna in the wilderness, Ex. 16. It took only a moment for Jesus to tell them than everyone died who ate that bread. Besides, Jesus pointed out that God gave it, not Moses. Then He taught that He is to spiritual life what bread is to physical life. God's will is that all who

continually seek such a "fare" will always have life that lasts time eternal in heaven.

The listening crowd then discussed among themselves how Jesus could say this, since they knew both Joseph (and Mary). (By the way, does this teach anything about Joseph still being alive? Has the Scripture ever told us Joseph had died?) Their conclusion: "Jesus, your claim is false!" They measured by human standards though, and disregarded other truth that was given. They were wrong. May we ever consider all the truth, and not cut ourselves off from that which would produce life eternal in us if we accept it. The teaching of Jesus is to a spiritual end unto life, v. 63. Participation in Christ will bring a quality of life ever satisfying, v. 51, 58. He is to be considered from a different perspective than flesh (or bread) and its inevitable decease. What He teaches is from a "spirit" point of view, with "life" the end in view, v. 63.

This conclusion is based upon the fact that to believe on Him is to have the true bread, the true "Moses," the true source of life, and the true word of life. Jesus shows how important He is to all who come to Him, vv. 37-40 (acceptance, security, and resurrection), who come through being taught, vv. 44-46, and who find the imperatives for spiritual life, vv. 49-58. In connection with this whole text, note Col. 3:4; Gal. 5:16ff.; Heb. 10:20; I Pet. 2:2; Rom. 8:1-16; Isa. 55:1-11.

We are persuaded that this text has nothing to do with communion at all. It directly and specifically teaches that Jesus is the means of life, for life is in the Son, I John 5. One might enhance his spiritual life during communion, but it would not necessarily come about because of the emblems taken into the body. If those who teach such doctrine really believed that it was so, they should make every effort to have every child of God partake every Sunday (why not every day, since it is quite possible

THIRD YEAR MINISTRY

that Acts 2:46 teaches a daily communion was practiced in the early church), even to those who do not come to services. Otherwise, as some teach, those who do not partake have no life in them—until they do. This really becomes a law system, quite unlike a faith system. It actually boils down to a week-by-week in Christ or out of Christ for everyone who claims to be a Christian. That the Bible does not so teach the faith-life is our persuasion.

Capernaum—Matt. 15:1-20; Mk. 7:1-23

While at Capernaum, the confrontation of Jesus with some Pharisees and scribes took place, Matt. 15; Mk. 7. These men had actually found ways of circumventing the command with promise (the fifth) by use of tradition. Jesus taught that such misuse of tradition actually voided God's word which they were ostensibly upholding. Such "doings" were defiling to a man, Matt. vv. 18-19, and were rather to be avoided than what was being taught as important (like washing one's hands before eating), which was not defiling.

Are we so busy holding on to tradition that we actually let go of God's Word? We might paraphrase verse 9 of Mark's gospel thus: "It is really wonderful to see how you set aside God's laws for the sake of your own." How ironical! Jesus taught that we became defiled by such action as this. What cesspools our minds can become once we begin to lead double lives, Matt. vv. 7-9. We are the "thing unclean" rather than some other thing. Immorality always defiles! and that is a grave issue!

Jesus had little patience with people who knew God's will but refused to do it. He had no patience at all with tradition—one could take it or leave it. Much of our "worship services" is but tradition. You will not find any order of service in the N.T. Such things as the

invitation hymn are non-biblical, as well as church boards and revival meetings. Do these things become a law in themselves? If they do, they are wrong. The only thing that honors (is blasphemy the opposite of honor?) God is a pure motive and obedience to His will. Anything else makes us a subject of Isaiah 29:13.

The issue then is, as hinted at above, the thing(s) we do and our motives for so doing. There is nothing wrong with *thought*, but wrong thought is evil. Society has the right to enforce justice even to the death penalty, but taking the law in one's own hands and killing someone is wrong. Sex relationships between husband and wife are ordained of God, Heb. 13:4, but any others are wrong. These are ways we defile self: by making "rules" where God has not. When we keep what we think is right (our rules) and ignore God's, we become defiled and are wrong. We are the only moral creation God made. Therefore we alone can be morally defiled, in the making of wrong choices. As stated in Mk. 7:19, nothing is unclean in itself in a religious sense, but its misuse can make the user unclean. See Romans 14:14, 20. The only true religion is from God: get it and keep it!

Phoenicia—Matt. 15:21-28; Mk. 7:24-30

This country was along the coast, beginning at the Gulf of Acco, just north of Mt. Carmel, and probably extending some two hundred miles north to Ras Shamra-Ugaret. The Lebanon Mountains on the east, and the Mediterranean Sea on the west completed its boundaries.

The peoples were likely Semites who came during the second millenium B.C. These people were also known as Canaanites, and were probably originally descendants of Ham, Gen. 10:6-20.

The people could not sustain themselves easily on the

THIRD YEAR MINISTRY

small amount of land available, and as good harbors were available, the nation became sea-faring, and grew to be a nation known for its sailing ships and sailors. The nation became associated with its cities (as Greek cities were) rather than any definite area of land. Tyre and Sidon especially appear in ancient records as notable, with Acco and Dor less often mentioned.

The Egyptians under Thutmose III conquered the land around 1471 B.C. Egyptian influence waxed and waned for the next several hundred years. During David's reign (1010-970 B.C.), an alliance developed which continued and included trade during the days of Solomon. When the kingdom split under Rehoboam, Phoenicia sided with Israel. So it is not strange that Ahab took Jezebel to wife, and the prophets of Baal along with her.

We are then introduced to worship of Baal and Ash-toroth in the nation of Israel, and subsequently to Elijah's contest with priests of Baal in I Kings 17.

The centuries that followed saw the land invaded by such as Ashurnasirpal (884-860 B.C.), Tiglathpileser III (745-727 B.C.), Sennacherib (705-681 B.C.) and Nebuchadnezzar (604-552 B.C.). Finally, the Greeks under Alexander took the land (ca. 330 B.C.) and fulfilled the prophecy of Ezekiel 26-28.

The division of Alexander's kingdom at his death saw the land first under the Ptolemies, and after 197 B.C., under the Seleucids of Syria. The reference in our text to the woman's nationality (Canaanite woman, Matt. v. 22, a Greek, a Syrophenician by birth, Mk. v. 26) reflects a century and a half of Syrian rule.

Why Jesus went to this country is but a guess. It was apparently the only time He left the land of Palestine (as we think of it) during His ministry, though the journey to Caesarea Philippi during this same six month span should be noted.

As usual, Jesus could not be hidden. People from this area had probably been to hear Him before, Matt. 4:24, and this doubtless brought Him to their attention.

Faith is invariably rewarded, especially when motivated by love. The woman who captures our attention exhibits both. The disciples tried to thwart her efforts, and Jesus even seemed to refuse her request for help. But she did not turn loose (cf. Jacob in Genesis 32) and the "crumbs" were hers! May we observe that whatever the tragedy in our life, faith and love yet should be manifest to all who see us.

Decapolis—Matt. 15:29-39; Mk. 7:31—8:10

Leaving Phoenicia, the group journeyed to the Decapolis area east of the Jordan identified as Transjordan. Continuance of the healing ministry by Jesus brought great crowds again, and glorification of "the God of Israel" was the result. Might our ministry, whatever we are, whatever we do, be aimed at the same result. We, like these people, need to see Jesus as the One Who "has done everything well," and tell others so.

The crowds stayed with Jesus, and on one occasion as day two passed into day three, Jesus decided to provide for their physical needs. We can hardly imagine the reply of the disciples (Mk. v. 4) after thousands had been miraculously fed some three to four months earlier, yet they are aghast at the suggestion of Jesus. The place was not close to any inhabited area (the word "desert" in the Bible means a place uninhabited by people, but not in the sense of arid, barren, etc.) and they seemed not to recall the past. But Jesus soon displayed His compassion and all were fed. Seven large baskets were gathered of the broken pieces remaining. Compare the discussion under point 36 for other information about the baskets.

THIRD YEAR MINISTRY

Magadan—Matt. 16:1-4; Mk. 8:11-13

This region (also known as Dalmanutha) on the northwest side of the Sea of Galilee has been visited before by Jesus, with some ministry there. This time, however, Pharisees and Sadducees (what strange bed-fellows these people are! But Jesus was a common object of their hate) came to ask for a sign. They were not unlike others (cf. John 2, 6). Undoubtedly, when Jesus finished with them, they wished they had never bothered to ask. He detected a false motive (Mark's gospel, v. 11, uses a Greek word which means 'to dispute') and rebuked them by showing they were adept enough at "seeing" some things. The same discerning ability could have been used to perceive the lessons from other signs He had done. Jesus refused to be put on trial, though He again spoke about the greatest sign of all to be given later (ref. Matt. 12).

Sea of Galilee—Matt. 16:5-12; Mk. 8:14-21

Under the discussion of points # 36, 37 and also John 6, we pointed out that the disciples did not grasp the significance of the miracle in the feeding of the 5,000. They did not even after Jesus pointed out their unbelief. Now they again are so materialistic in thinking that they give evidence of the same kind of unbelief as among Israel in general. Jesus asked rather pointed questions to get their thoughts back on the track—like "are you guilty of a hard heart, too?" and "why do you not yet understand?" (Mk. v. 17, 21).

Perhaps it is as true with us as with them! How very often we do not think God's thoughts, or express the life of godliness. Paul had to admonish Christians to "Think like your Lord," Phil. 2:1-11, and, "Be ever conscious of heavenly things," Col. 2:20—3:4. The reason:

Christ is our source of life, and none else, Col. 3:4. We must ever watch for the corrupting influence of false teachers. Leaven is a fitting symbol for anything (whether good or bad) that gradually but surely affects other things.

False teaching will as surely lead us astray as true teaching leads us to Christ. Neither teaching will do it in a moment, but either will ultimately produce, if we provide a place for the "leaven" to work, or (to change metaphors) a seedbed for the seed. Do we understand that the danger in life is not from starvation physically but starvation spiritually? If we listen to false teachers, we will inevitably separate ourselves from the only source of life: Jesus, the bread of life. We too could listen to "Pharisees" in our day, who promote a facsimile of religion (Lk. 12:1) but deny the power of it, or "Sadducees" who make this life the sum total of existence.

Bethsaida—Mk. 8:22-26

"Jesus never fails!" says the song writer. "And the blind came seeing" aptly describes the text at hand. The man had apparently lost his sight, but not his friends. They brought him to Jesus for help. The healing provides an interesting variation to the way Jesus normally healed. Why He chose to heal the man by stages is not stated, and speculation is useless. The man was healed, and that is definite. We cannot decide why Jesus forbid him to go into Bethsaida (Julias). Perhaps Jesus did not want any more attention at the moment.

*Caesarea Philippi—Matt. 16:13-28; Mk. 8:27—9:1;
Lk. 9:18-27*

Caesar! I believe that . . . ! First among equals!
Mystery disclosed! Such are among the interesting items

THIRD YEAR MINISTRY

brought to our attention by this text. These four items are chosen out of others (that definitely might be helpful) because of space.

Caesarea Philippi was in a district called Paneas in N.T. times. It is at the north end of the Jordan Valley some 1,150 feet above sea level. Mt. Hermon towers above it at 9,100 feet. In O.T. times, it may have been the Baal-gad of Joshua 12:7. For centuries, it was the place of worship of the heathen god "Pan," whence its name. It is known as Banias today. The eastern most source of the Jordan River flows out of a cave nearby, with a second source some two miles west near the ancient city of Dan, Judges 18:20; Ezek. 27:19; I Sam. 3:20; I Kings 12.

Caesar Augustus had presented this whole area to Herod the Great, who built a temple there in Caesar's honor. The area became the inheritance of Philip (the tetrarch) of Iturea who married Salome, his grandniece, born of Herodias (who had first been married to Herod Philip, a half-brother) and Herod Antipas (half-brother to Philip and Herod Philip and an uncle to Herodias). Herod Antipas (Antipater) was called the "fox" by Jesus, Lk. 13:32, and the one to whom Jesus refused to speak, Lk. 23:6-12. He and Herodias together killed John (see point # 35). Philip was seemingly unlike his father, or some of his brothers, and his reign was much different. He beautified the town of Paneas, renamed it *Caesarea* in honor of Tiberius, and *Philippi* for himself. The city later came under the rule of Herod Agrippa I (who died in A.D. 44, Acts 12) and his son, Herod Agrippa II (Acts 25 and 26), who changed the name of Caesarea Philippi to Neronias, in honor of Nero.

"I believe that You are the Messiah (Christ) the Son of the living God." "Peter, you are correct. This truth will be the authority for founding a new age, the age springing from a new covenant from God with people.

The fact of Who I Am precludes any defeat of the church, whether by powers, or things present or death or whatever (cf. Rom. 8:29-39). It has been revealed to you even from my Father."

Thus it seems to us is the gist of Peter's "confession" and the reply of Jesus to it. The confession is most important in many respects, because it spells out exactly what must be believed by a "would-be" follower of Jesus. It will not do to think of Jesus as being anyone (or anything) else. A prophet will not do for our sins. We must have a perfect sacrifice (Heb. 10:1ff.). Jesus is that sacrifice. Again, to suggest that Jesus was but a prophet is to miss the whole emphasis of the N.T., and to avoid what Jesus considered indispensable. We must get these two facts together, and believe it is so, that 1) Jesus of Nazareth is 2) the Christ, the Son of God. Nothing else will suffice. No one else can save us from our sins or has the authority to say and do what Jesus said and did.

This confession is so easy to say, but it takes a lifetime to comprehend. A Christian is forever learning what that simple statement means. The whole Bible is the background for understanding it. The exact and full comprehension of how God became flesh (Phil. 2, John 1, etc.) has eluded the greatest of thinkers, and yet does. Yet this fact of who Jesus is must be the point which we try to impress upon unbelievers. This they must believe before being able to change their mind (for acceptance of Jesus' authority as Lord is a requisite to bring a change of will and life, i.e., repentance), and be immersed into Him. Otherwise, immersion is a farce. We are not persuaded that this fact needs to be stated before immersion, though that is all right, but it surely must be believed. The believer's life is a continual "confession" of this truth about Jesus, Matt. 10:32.

THIRD YEAR MINISTRY

First among equals! Jesus taught many things, and the Holy Spirit came to teach many more things, John 16:7-15, etc., but you will read in vain for a scripture that says Peter was considered first among equals. The Catholics teach this, but not because they find it in their Bibles. The rest of the disciples did not understand Jesus to say this, in our text, or any place else. Consider to what purpose would the disciples argue who was greatest among them (Matt. 18:1ff.; 20:20ff.; Lk. 22:24ff.; and note I Cor. 3:7; Gal. 3:1-21, etc.) if Jesus had so spoken? If Peter were first, why did Jesus not say so in Mt. 18 when they were discussing it? Jesus was speaking to Peter here, but consider the texts in Matt. 18:15ff., and John 20:23. All are told about their personal relationship between God and sinful men. The relationship is identical for each of them. Truly, these men (and us, too!) were the "missing link" between Jesus and sinners.

The religion we know as Christianity is *a mystery revealed* as Jesus teaches many times, as in Matt. 11:25ff.; our text; I Cor. 2; Gal. 1:6-9, etc. We do not have a religion dreamed up, or experienced and told, but a God-given covenant, Heb. 8:8-13; Jude 3. We have no power to alter it, nor do aught but proclaim it, for the message brings salvation, I Cor. 1:18ff.; 15:1ff.; Rom. 1:16-17; 10:17; etc. This is one reason we must adhere to the written word, since anything else is man's idea. God spoke to us through His Son, Heb. 1:1ff., and He has the words of eternal life, Matt. 7:24-29; John 6:68-69. The religion is a propositional religion, in that it presents something to be accepted or rejected. The basic proposition is, of course, that which Jesus asked of the disciples: "Who do you say I am?" It is thus a system of truth (implying other systems are false.) Jesus is the truth, so no one else is, for all are imposters. He is the way, and implied is that all others are not. Life is only found in Him, and

all others bring only death. Christianity is thus a system built upon antithesis: right-wrong, truth-error, good-evil, Jesus-imposters, God-no god, etc. It is a religion of rationality, not irrationality. Peter (and everyone else) had to hear facts, come to understand their relationships to Jesus, and conclude that Jesus of Nazareth is the Christ, the Son of God. He accepted this as *the truth*. All other systems were false. So it is with us. We act on faith, the trust we have in Jesus, about Whom we have learned. We reject all other religions as being wrong, as error, evil, etc.

Many religions of our day are non-rational, such as any existential religion. Simply put, they teach that when one "feels" like one is saved, one is. The Bible never states that one time as being so. Rather, facts about Jesus proclaimed, and accepted as true, then acted upon make one a Christian. Nothing else does.

Verse 19 teaches a revealed religion. The words of Jesus should be understood as follows: God will direct your preaching, so that His will for men is expressed by you. Whatever God decides is binding, you will bind upon men. Whatever He decides should be freed, you will indicate the same to men. The result will be that men will know exactly what God wants of them, and they will know it through your proclamation of it.

The point is this: some take the verse (note Mt. 18:18-19; and see Jn. 20:23) to say that whatever the apostles preached to men, God was obligated to honor. That idea is exactly opposite of the truth. Many times the apostles made mention of the fact (as did Jesus) that what they taught was God's Word and the message had not originated with them. (See Jn. 12:44-50; Acts 26:22-23; I Thess. 2:13; Heb. 1:1-2; 2:1-4, etc.)

We note that Jesus yet had few who believed in His deity, though many would acknowledge God's presence

THIRD YEAR MINISTRY

in His life (cf. Mt. 21:9-11; Mk. 7:37; Lk. 7:16; Jn. 3:2). An immense difference exists though between asserting what Peter did (and what we must) and what "some" others were (and are today). The difference is heaven or hell. Such has God revealed.

Peter was not different than many others. When Jesus began to speak about His forthcoming mistreatment and death, Peter attempted to order things differently as expressed in Mt. 16:21-23. His ideas surely did not agree with God's. In fact, they expressed Satan's. But God's ways are best. So Jesus rebuked Peter promptly, not only to show that man's thinking is only good insofar as it reflects God's, but to reject a subtle temptation from the devil. Certainly the cross was not a *logical* necessity. God doubtless could have saved sinners other ways. But He had determined to do it by the cross. So Jesus' death was a *moral* necessity, Lk. 12:50; Heb. 10:7; I Pet. 1:11.

So a leader to the rear! This is always a problem in the church. Note Paul's advice to Timothy, 1:3-11; and John's remarks about Diotrephes, III John vv. 9-11. To counteract such in our lives, we must decide to follow Jesus *daily*, denying self *daily*, being proud and not ashamed of Jesus and His teaching *daily*. In this way we can avoid "giving orders" and be willing to take them.

*A Mountain Unknown—Matt. 17:1-20;
Mk. 9:2-32; Lk. 9:28-45*

Our attention has been held by the picture of Jesus, a remarkable picture drawn of Him by Peter and then by Himself, as God's Son, coming in glory and triumph in the kingdom. How marvelous are the things God did for Peter and the disciples. But a greater event yet: the verification of what they believed to be true about Jesus.

The transfiguration of Jesus surely was the climax of all, and how timely in view of what it taught about Jesus' relationship to God. Jesus transformed in their presence, the obvious lesson in Moses and Elijah, God's voice in acclaim and command: all these served to validate the truth in the confession they had just made. God does things up right!

The location of the high mountain is unknown, but it is possibly Mt. Hermon. However, it may have been another mountain of the area.

Why Jesus only took Peter, James and John along is also unknown. Seemingly the presence of the group was known, since a crowd gathered where the other disciples were, though perhaps they might have gone into a village where people would become conscious of their presence.

"Born to die" is the word about Jesus. Moses and Elijah, perhaps symbolic of the law and prophets, spoke with Jesus, not about His birth, or boyhood, or pre-incarnate glory, but about His "exodus" soon to be made. Certainly Jesus' death occupies a prominent place for these men to be conversing about it! But how far-fetched and unthinkable for the listening disciples. They could not picture a "suffering servant" being the promised Messiah. How very often they avoided the truth or rejected it. See the reaction again in Mt. 16:21ff., and here in 17:9; in 17:22-23; and Lk. 18:31-34. The fact was also presented in Lk. 17:25 and Mt. 26:1-2, even before the events of the last supper and the prediction there. Lk. 24:13ff. depicts clearly how little of His teaching His followers really understood or accepted. The expression of Peter in our text is typical. Do we ever get above the world in which we live?

Law and prophecy became grace. This is a good way to understand what the whole event portrayed—and why

THIRD YEAR MINISTRY

the suggestion to build three tabernacles was out of place. Moses and Elijah are not equal to Jesus (cf. Heb. 3:1-6; I Pet. 1:11-12; Heb. 11:39-40; then 12:1-2). We are to "keep hearing God's Son (only)." The law and the prophets fulfilled their purpose, Gal. 3:24ff.; John 1:45; Lk. 24:44-46; Rom. 3:21; as did John, Mal. 3:1; 4:4-6; John 5:33-36a; Mt. 17:10-13. Jesus is our theme now!

Jesus came to serve, not to be served. The text of Mt. 17:14-20 concerning the healing of the demonized epileptic boy, and the assurance given to his father is a thrilling display of this truth. The nine disciples could not perform the task. The reason: lack of faith (in God). They did not ask God's help. They were perverted (turned from God) was the reason they did not ask. We may be sure of a complete failure when faith grows small. We are never static in respect to God.

The boy, possessed by a deaf and dumb spirit (demon), was promptly healed in answer to his father's request. We like the thought expressed by Jesus in verse 23, "If I can?" As with the leper in Mt. 8:2, the issue is not dependent on God (or Christ), but on us. We need to be like Paul in Phil. 4:13. Let us have a "sense of the possible!" The man's statement in verse 24b is so human—how well he expresses what is so often true of our lives. We have so very little to commend God's help. But God wants to do for us, so let us ask!

Consider in passing that the boy, who was the one healed, was not asked by Jesus to have faith. He may not even have known what was taking place. Those who always blame a "healing failure" on the faithlessness of the person involved are not like Jesus. He blamed the disciples who should have been able to heal the boy. The subject of demons has been discussed under point # 24 (2).

Capernaum—*Matt.* 17:22—18:35; *Mk.* 9:33-50;
Lk. 9:46-50; *Jn.* 7:1-9

"Let's go fishing!" Many times that expression had been uttered by Peter, we suppose, but one fishing trip, as recounted in our text, undoubtedly was unique. Of all the fish he had ever caught, probably none of them was like the fish this time—for it had money in its mouth, a shekel (Greek 'stater', equal to a shekel) to be exact. One can not help but wonder what sort of a "fish story" he told—or if he told it at all. (Who would believe such a story?)

It all started over a discussion by Peter and the collectors for the temple tax. They ask him if Jesus paid it. Every Jew over twenty years of age was to pay this as stated in Exodus 30:11-16. Joash had enforced it after the death of Athaliah for the rebuilding and refurnishing of the temple, as recorded in II Chron. 24:5-14. Peter had answered in the affirmative. Jesus, with His ability to know all, asked Peter a seemingly unrelated question, or at least a question without explaining why it was asked. To Peter's reply, Jesus drew a logical conclusion that taxes were only exacted from subjects of kings. The obvious implication: Jesus was God's son, and not liable for taxation. But as in all of His life, Jesus subjected Himself to the law, if not for any other reason, just to set a godly example.

"Childlike, not childish!" Discipleship is a many-splendored thing, and ever a challenge. The men who followed Jesus vividly illustrate the "dos" and "don'ts" of being a learner in the school of Jesus.

As stated under point # 45, the disciples did not understand Jesus to have designated Peter "first among equals." Therefore, they found occasion to discuss the subject of relative greatness on the way from Caesarea

THIRD YEAR MINISTRY

Philippi to Capernaum. Seemingly, Jesus did not hear (they did not want Him to hear) the discussion, but upon arriving in "the" house (Mark v. 33—more than likely Jesus' house, as the Greek article is sometimes used like our possessive "his"), He asked them about the discussion. No answer was forthcoming (they were ashamed). Jesus gave them the illustration of true greatness: a child. The follower of Jesus is not to mimic all of a child's traits, but some are of value. Humility is one of these. In contrast to adults, children are "insignificant." The disciple must consider himself with *true standards* of measure (Rom. 12:3 "soberly") and not *over-evaluate* as the disciples were doing. James 2:1-13 and Luke 22:24-27 point our thinking in the proper channel in this regard. We must see things from God's point of view, Mark v. 37. Any other action might result in being a stumblingblock (see discussion under point # 61 (4)) and the consequences of that are "worse" than being drowned in the sea.

One can draw the "circle of fellowship" too tightly, and eliminate some who are *for* the same goals. Perhaps the cause of such drawing is thinking of self too highly. The disciples were guilty of this. Jesus had to point out that all the facts must be considered before fellowship is determined. The end result of a work is the criterion for inclusion. Even a small cup of water is to be considered.

One should then be careful not to despise (it means to 'think around' or 'ignore') those whom God accepts. Drastic measures should be taken if one tends to do these things. The disciple of Jesus must be the example that preserves the right attitude among brethren especially and the world in general. No one else is salt! God has sought and found many *lost sheep*: the disciple does not dare be the cause of the sheep becoming lost again.

Hence, every effort must be made to keep the group intact—especially in the area of forgiveness of others (see Mt. 6:14-15). The disciple then must forgive even as God does—God does not “keep track” of times forgiven. Love does not *add up* evil, I Cor. 13:5b (the Greek word means ‘reckon up’ or ‘keep track of’). Only after diligent steps are taken is a person to be “written out.” A personal effort, alone and then with others, and a third attempt—all are to be done in an effort not to be a stumbling block or to wrongly act against another *brother* (or *sister*). The reason? the brother is to be gained, if at all possible. He is the object of concern. Our forgiveness must be unlimited if repentance is forthcoming. Again, God is our model.

The last section of text brings the advice of the brothers of Jesus to our attention. They thought like most worldly people: greatness is accomplished by much acclaim—so go where you can be noticed by many. God’s ways are not man’s ways (remember Mt. 4:5-7?), so Jesus did not follow their advice. They seem to have at least misunderstood Him so much as to not be believers in Him until after the resurrection, Acts 1:14. Perhaps this is the reason at the cross Jesus committed his mother to John, His cousin and her nephew. He apparently waited to go up to the Feast of Tabernacles until they had gone.

Samaria—Lk. 9:51-56

Paradoxes are considered by some to be akin to a “charley horse” between the ears. Be that as it may, Luke’s brief account about a night’s lodging denied for Jesus and His disciples certainly presents a paradox in the “sons of thunder.” One seldom thinks of John as anything but a man lovely and loved, kind, concerned, helpful. Yet in our text, he would have cheerfully (?) destroyed a whole

THIRD YEAR MINISTRY

village of people, simply because they were born on the "wrong side of the tracks." How ceaselessly interesting it is to behold the change in someone through allegiance to Jesus. Bruce's *The Training of the Twelve* shows how Jesus molded and made His followers into new men, not physically, but mentally. Jesus and Satan are ever in conflict for control of the mind—because a man's thinking determines his action. Convince a man he is but an animal, and he will act like one. Get him to believe that he is of a superior race, he may want to destroy a city. The Bible does not speak idly about believing the truth or believing a lie, II Thess. 2:11-12. John changed, and became the apostle of love. Jesus brought about that change—have you tried Him? He never fails, if you are willing.

LATER JUDEAN MINISTRY (about 3 months)

Jerusalem—John 7:10—10:21

(1) and (2). God made man by nature gregarious. Fellowship is thus a major interest in man's thinking and especially of God's people. He gave the Israelites three major feasts to help keep the nation of the Jews aware of each other. Notice how quickly Jeroboam changed feasts and locations when he became king over the ten northern tribes, I Kings 12:25-33. Fellowship and consequent strengthening of ties with those in the south had to go! One can hardly suppose the word "fellowship" in Acts 2:42 speaks of the union all believers had in Christ. There is no point in mentioning such an idea in the context of things believers do, such as prayer. The thing in question was association together, as in the worship and preaching, etc. See Heb. 10:25 for this idea.

The Feast of Tabernacles was held in the fall at the conclusion of the harvest season. It was a feast of thanks-

MAP NO. 5—THIRD YEAR, LATER JUDEAN MINISTRY (about 3 months)

1. Temple; Feast of Tabernacles; Sermons on Light of World; Freedom; Abraham's Children; Man born blind healed; Good Shepherd; 70 sent out to evangelize, Jn. 7-8-9-10 & Lk. 10
2. Bethany; Jesus, Mary & Martha, Lk. 11
3. Place of Prayer; Discourse on Prayer, Lk. 11
4. Place unknown; charged with being in league with Satan, Lk. 11
5. Dining in Pharisee's home; denounces Pharisaism, Lk. 11
6. Before multitudes of 1000's Great evangelistic appeals on Hypocrisy, Anxiety, Covetousness, Lk. 12-13
7. In a Synagogue; heals woman bowed double; ~~controversy~~ controversy over healing on the Sabbath, Lk. 13
8. Feast of Dedication (December); Jews seek to kill Jesus, Jn. 10

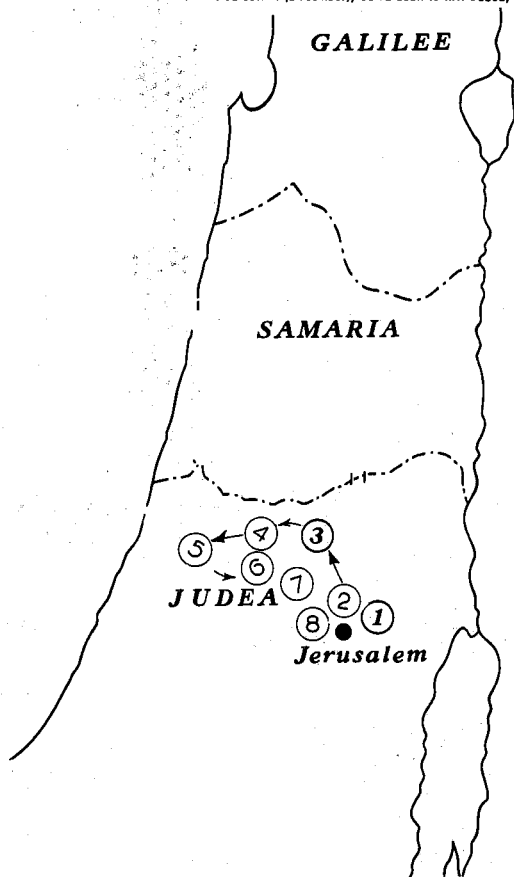



THE SEA OF GALILEE

giving and remembrance, held in a sort of "country fair" style. Jesus, as all other male Jews of age, was required to attend. Upon arrival, one of the most illustrative discussions of Jesus' ministry occurred. Note the different thoughts expressed *about Jesus* during this feast: 7:12 a good man, a seducer, v. 15 puzzlingly knowledgeable, v. 20 deluded and demonized, v. 26, 31 perhaps equal to the Messiah, v. 40 the prophet, v. 41, the Messiah, v. 46 unique; 8:13 self-exalting, v. 49 demonized and a Samaritan, v. 53 not as great as Abraham, v. 59 a blasphemer; 9:11 a man called Jesus, v. 16 some: not from God for a sinning Sabbath breaker, others: if so, how could He do such a miracle, v. 17 a prophet, v. 22 association with Jesus deemed sufficient reason for excommunication, v. 24 a sinner, v. 29 not as great as Moses, and origin unknown, v. 33 obviously from God.

Not less significant are the claims of Jesus *about Himself*. Actually, considering the whole section, He makes more varied and explicit statements concerning His relationship to God and people than in any other public discussion. It is no great wonder that plans to kill Him were brought into action, 7:32, and the reaction to the raising of Lazarus so violent, 11:50, 53, 57, 12:10-11; and the offer of betrayal by Judas so welcome, Lk. 22:3-6. Note too the disconsolate Pharisees in John 12:19, the frenzied efforts of the leaders as in John 19:6, 15, and their insolence, Mt. 27:39-40. The two disciples on the way to Emmaus remark about their actions, Lk. 24:20.

During the Feast of Tabernacles, the priests brought water from Siloam to the temple, and the temple courts were lit at night with torches. Consider how Jesus uses these ideas to teach about Himself, 7:37-39, 8:12ff. and 9:5. He claims God as His teacher 7:16 and 8:28, to have been sent by Him 7:28-29 and 8:42, 56, as a co-witness 8:18, as glorifying Him 8:50, known and loved

THIRD YEAR MINISTRY

by Him 10:15, 17, returning to Him 7:33, and a Son, 8:36. So obvious should be this relationship that anyone desiring to know it can, 7:17. Ever in the background is the idea of His sacrifice 8:28, 10:11, 15-18; and judgment intrusted to Him 8:26, 9:39. The idea of ultimate destiny based upon accepting or rejecting Him keeps popping up, as in 8:24, 34-36, 51-52, 9:39-41. In this connection, the reference to the evil actions of people and the ultimate source of such is made plain in 8:39ff. Anyone who claims to be a descendent of Abraham will give evidence of it by right living, 8:39. The life of faith does not reject God or His messengers.

The claim in connection with Abraham, 8:56-58, brings to mind the obvious parallel in Exodus 3:13-14. This claim for equality with God is implicit throughout the whole sermon, though, and is thus not surprising.

Chapter ten clearly sums up the whole discussion by presenting the idea that He alone is the true shepherd to be followed, and only those who do so are the "sheep" who will have "pasture" and "shelter."

(3) Chapter nine presents as good a test case about Jesus as any incident in history. The searching inquiries by the Jewish council could hardly be improved upon today. Everything a modern court could do was done, such as examination of the "defendant," and other witnesses who could verify the pertinent facts about him. The facts in the case were readily available, and as the healed man finally concluded, pointed out Jesus as being from God. Admiration is surely due the man for he gave up all that had been important to him for the man rejected by his erstwhile leaders. A complete break with one's past is always required, though, for naught else is acceptable. If honest appraisal is given Jesus, the person so doing will progress down the same road of faith as

did this man, from the man Jesus, v. 12, to God's spokesman v. 17, (triumphantly) to the Lord, v. 38.

His steadfast and growing admiration of Jesus is also seen in the give and take with the council.

The Pharisees had reasoned thusly:

(All who keep the Sabbath are alone from God),
This man does not keep the Sabbath,
(therefore) he is not from God.

But he reasoned that:

(All who can open blinded eyes are at least prophets
of God,
This man opened my blinded eyes,
therefore) he is a prophet of God.

They replied:

(All Sabbath breakers are not men used of God)
This man is a Sabbath breaker,
(therefore God did not use him to heal you.)

And since this is so,

(All who are healed should give God, who alone can
heal, praise,
You are obviously healed,
therefore) give God praise, (not this (deceiver and)
sinner.)

Undaunted by their "know," he replied, in effect, that he might not have been among those who knew what Jesus was or was not, but he was among those who knew about his own life, and he knew that he was formerly a blind man now able to see. He then presented the argument that a blind man with his cane could see clearly that:

THIRD YEAR MINISTRY

Only a man in touch with God is capable of opening eyes of people born blind, since no mere man has ever done it,

I, born blind, now see through this man,
hence, he is of God (even if you blind men can not see it!)

Could all of us who consider this marvelous miracle be as willing to ascertain the facts and act upon them as did the man healed.

Perhaps it is worthy of our time to consider the "I ams" of Jesus found in John's gospel, as well as the idea of Jesus' consciousness of time. References to assertions by Jesus in reference to His identity are, besides the I am of 8:58; I am the Messiah 4:26; I am the bread of life 6:35, 48; I am the light of the world 8:12; I am the door of the sheep 10:7, 9; I am the good shepherd 10:11, 14; I am in the Father 10:38; I am the resurrection and the life 11:25; I am the way, the truth, and the life 14:6; I am the true vine 15:1, 5. Note also the several "I ams" of chapter 17.

Jesus was "God-conscious" all of His life, and this is evident many ways. One of those ways is His frequent mention of time in relationship to His life. Consider then the following references to time: Jn. 2:4; 4:23; 5:17, 25; 7:38; 8:20, 56; 9:4; 11:4; 12:23, 27; 13:1, 31; 16:25, 32; 17:1; Mt. 26:45.

Perhaps a brief discussion of the passage contained in some versions, 7:53-8:11, merits our attention. As remarked in the comments on John 5, we are only interested in what has been written by inspired men. The Greek text from which we translate our English New Testaments is a composite of at least the following sources, 1) Greek manuscripts (abbreviated Gr. MSS) which are copies of other Greek MSS and, of course, ultimately of

the original autographs, 2) copies of the Gr. MSS in other languages, such as Latin, Syriac, etc., and 3) quotations in early commentaries and such like by Christian writers (or even non-Christian writers). The reader may peruse the article in the special studies for more details. The lack of evidence for the inclusion of the text in question far exceeds the evidence for it. The question is: did the apostle John record such an event. The best available evidence is that he did not. The exclusion of this text makes no difference to the text, for it makes as good a sense without it as with it. As it stands, one wonders why the men did not bring the male accomplice along with the woman, since the law required both to be stoned, Lev. 20:10; Deut. 22:22. If the text is not included, no doctrine is lost. If one wishes a text like this from which to preach, there is a similar text in Luke 7. Personally, we think it is much better not to use texts that are of such questionable nature as this one.

(4) John 10:1-21 perhaps is the conclusion to the day's discussion with the man and his religious leaders. We think of the words to the song, "Amazing grace, how sweet the sound, that saved a wretch like me; I once was lost, but now am found, was blind but now I see." How tragic, though, to have seen (or now see) the difference Jesus made in the life of one man, and refuse to allow the same Jesus to work in one's own life—seeing but blind!

Perhaps the reason many were in such state then, and even now, is that they were unaware of the good shepherd, and followed another shepherd, going through the wrong door. Such was the case with the ones who tried the blind man, and were found wanting . . . sheep lost and straying. And the pity of it all is that the shepherd they claimed (Moses) had pointed them to the good shepherd (Jesus) and they refused to follow! It is not a wonder that Israel was sinful so many times, if all their

shepherds were like these men. Ezekiel 34:11-16 condemns men of this sort in any day.

Jesus offered abundant pasture, adequate protection and a personal allegiance to His own—seemingly a bargain to anyone. Yet many considered Him “out of his mind” and demonized, though others rightly argued that demons only put eyes out and add to a person’s woes. They might be more excusable then because they were so close to it all and found it hard to see what Jesus actually meant by His words. But we, in historical perspective, can see that He really did love the sheep enough to give His life for them, that He was no hireling who leaves the wolf with a free meal (see the ideas Jesus gives in Jn. 14:18; 15:13; and Mt. 28:20). Such love ought to constrain us to be a part of one flock, following freely the great shepherd of the sheep (Heb. 13:20; I Pet. 5:4) Who knows each by name. It is no wonder that the Father loved Him in consideration of His selfless sacrifice on behalf of the sheep. Jesus did not lose His life—He gave it! It is a marvel that so many of the sheep do not likewise love Him Who was not a victim of circumstances but a victor through love.

(5) The Seventy sent out—Luke 10:1-23. Some eight months prior to the time of our text, Jesus had sent out the twelve, with instructions to go only to the Jews. Their mission apparently was a success, as they utilized the power Jesus gave them to minister to the people. The mission of the seventy was not different in the regard, so the two accounts sound much alike in respect to the instructions Jesus gave them. The need was still the same, for preachers of the message of the kingdom, and for ministry in other respects.

Their mission was not an easy road, v. 3, but Jesus encouraged them to think of their labor as being for the Lord of harvest, v. 2. He would provide if they would

believe. Some would not listen, vv. 10-12, but others would be interested, vv. 6-7, and helpful. So courtesy and service, vv. 8-9, were to be hallmarks of the mission. The urgency of the mission, v. 9b, and the gravity of the message, v. 16, would be motivation enough if they so willed. The kingdom that can not be shaken, Heb. 12:25, and the good news of its king would be the gist of their preaching. Judgment to come would add impetus to every meeting held and conversation shared.

Faithfulness is ever rewarded and often in ways undreamed of. The commission given by Jesus did not include power over demons, at least in the part recorded, but v. 17 indicates the fact was so. If Satan is Lucifer of old, how interesting that his dazzling brilliance was overcome by the Light of the World! Yet, the seventy were not to find a cause of rejoicing in such things, but rather that each of their names was written down in heaven. Perhaps the only reason to rejoice over the fall of Satan is that someone else had been released from his power and another new name written down in glory.

Jesus' prayer in vv. 21-22 perhaps was prompted by the Holy Spirit, or because of the Holy Spirit in the lives of the seventy—but we, with Christ, can rejoice that God is not dependent upon human intellect for that which He does. The religion of the kingdom is a revealed, authoritative religion—and its possession is both a privilege and opportunity, vv. 23-24. So often we who can share fail to really appreciate what we possess (see Heb. 11:40 and I Pet. 1:10).

(6) The question of the lawyer as recorded in our text of Luke 10:25-37 might have been for self-protection or self-justification or even from unbelief, or maybe in response to a statement something like that in v. 24. When Jesus answered his question with one, he quoted Deut. 6:3 and Lev. 19:18, as He did on a later occasion. We

THIRD YEAR MINISTRY

wonder if he understood that loving God was fulfilled only as he kept the law, Rom. 13:10, or if he realized that the verses he quoted demanded active, not passive, living. The question of v. 29 may indicate that he did not so realize. The basis for all the law and the prophets was and still is the precept: practice (active) for others that which you want them to practice for you. The illustration Jesus gave drives home this point.

Opportunity beckoned to do the law when the thieves left the man yet alive. The thieves were not unlike countless others: they were the ones who hurt others for their own benefit. Parents who fail to rear their children as God wants, dope pushers, self-willed blind men—all such fall into the same category.

The illustration gets closer to home, for the man who was hurt (like many in every generation, unloved, unwanted, mistreated, ignored) could have expected help from the religious people of his day, could he not? But he was doomed to disappointment. Both the priest and the Levite had been to Jerusalem to serve in the temple where they were to teach others what God required of the godly life. Yet religion was but a cloak over hypocritical lives, for they did not translate what they taught into life—and passed by on the other side. Did you find yourself in the picture—the heedless Christian?

One least suspect (by the lawyer) is painted by Jesus within this miniature world of 4 people as being the one who helps, who exemplifies the person keeping the law. The Samaritan was the real lover (and law keeper) as he refused to dodge the living issue before him. He was the neighbor to mimic—willing to put himself out for others unable to help themselves. Prejudices laid aside, duties delayed—but the law observed. So Jesus said, "Go, and so practice."

Bethany—Luke 10:38-42

This small village of today (about 1,000 pop.) located SE of Jerusalem about $1\frac{5}{8}$ miles and situated on the eastern slope of Mt. Olivet is a familiar name to Bible students. Jesus stayed here often, especially during the last week. It does not appear on the pages of the O.T., unless the reference in Neh. 11:32 to Ananiah be its former name. The derivation of the name is uncertain, and may possibly mean the house of Ananiah, or maybe the house of the poor (or afflicted). The prefix "beth" means 'house of' in names such as this one.

Several incidents in the gospels other than our text are memorialized by various religious groups within or around the town of Bethany, including one for Lazarus. The Muslim inhabitants have identified a spot as the crypt of Lazarus, calling it el-'Aziriyeh. Whether we could identify with any accuracy such spots is very doubtful now, though the events and people themselves were very real. Other than our text, the events of John 11; the anointing of Jesus by Mary, Matt. 26, Mark 14, Jn. 12; the beginning of the triumphal entry; and the ascension was near here, Luke 24, Acts 1.

A song writer has captured the spirit of the relationship described in our text by the words, "a home Jesus loved." He also loved those in the home. Jesus may have often found rest and encouragement here, and perhaps even the food necessary for sustaining physical life as well.

Martha might have been aware of this physical need because she was busy with the provision for such needs. She allowed priorities to get out of line though, and became troubled and distracted. The thing Jesus forbid, Math. 6, became a part of her life. She went to Jesus and rather insistently asked Him to have her sister Mary

“take hold” with her (Rom. 8:26 uses this same Greek word for the help of the Holy Spirit). Eternal things must be first, Jesus replied, and Mary’s attitude was therefore the correct one. The preparation for physical needs was not wrong—but the attitude about it might be, and Martha’s was. She was indeed “over-occupied” about less important things, and sincerely mistaken. May we all learn the lesson she learned. We honor Christ only when we put first things first. The world and all that is in it passes away as it is used, but the one doing God’s will remains forever, I John 2:17. May God grant to each of us the opportunities to show that we believe it.

Place of Prayer—Luke 11:1-13

Jesus was doubtless asked many things, but the request of the disciples surely was welcomed for the opportunity to teach about prayer. Why the disciples asked for such, though, is thought-provoking. Was it because they did not know how to pray at all? Or because they wanted a new method of prayer? Many O.T. examples of prayer and prayerful people were available to them, such as many of the Psalms, Moses and Elijah, or I Chronicles 1, and 6. John’s disciples apparently prayed, Luke 5:33.

The answer given by Jesus may indicate some things. For instance, there is little that is really Jewish about it, yet it centers about the disciple’s relationship to God as reflected in his daily life. It was intended to show that disciples that a holy life is the best answer to such a prayer, though such life is often better caught than taught. Jesus’ example in prayer seemingly was the starter for the request.

The prayer itself, whether used as a pattern or actually uttered as given, did not indicate any specific time

to pray. "When" was vague in this respect: anytime, anyplace!

"Father" was non-Jewish for certain. Most Jews so revered the name (and person) of God that they would not utter it. The word "lord" became a substitute for the Hebrew names of God (note then the use of the word by Thomas, Paul, Peter, and others, for Jesus with this idea in mind). Jesus taught that the disciple was to have a personal relationship with God and though God and His name which represents Him (Psalms 9:10) was to be honored and held in respect (Psalms 111:9) yet they were to consider that He was not unlike their earthly father—interested, and approachable, and that willingly so. To "hallow" God then would be to treat Him as He desired, and let each life display the same sort of character as His life. Consider Lev. 19:2; Col. 1:22; Tit. 1:8; I Pet. 1:15 and Rev. 22:11 in this light.

The word "kingdom" carried various ideas to different people. To the initial hearers of this expression, perhaps the mental image of a great procession with trumpets blowing and banners waving, rich trappings and golden crowns came to mind. But the word also implied the principle of ruler and ruled, of king over subjects, of laws and obedience. It may be that your mental image is helped by Jesus' statement in Luke 17:21 that the kingdom is "among" (or within, as translated in Matt. 23:26) rather than outward and external. Yet, Jesus never specifically defined the word, and we can not quote any verse that specifically tells us how the Master intended for either His hearers or us to understand it. Considering the pictures drawn by Revelation, and other passages, the concepts of king, subjects, and rule are likely in mind, though other facts and ideas absent may need to be considered.

THIRD YEAR MINISTRY

The Bible always insists that God will provide every need as He views the disciple's individual situation. If the disciple would trust God to do this, then the request about bread for each day was quite appropo. The bread for tomorrow was not needed, Jesus implied, and the disciples did not need bread for yesterday, either. Daily provision should be considered all that is needed, then. But God's idea of need, not that of the disciples', was what determined His answer to each prayer. Jesus taught daily prayer for daily bread if for naught else than to remind each disciple to depend on God. Trust was the key to life, for in a very real way the righteous by trust lived.

Forgiveness is so much needed by every human, psychologically, or any other way, for the anguish that inhabits the soul which is unforgiven is devastating. No greater affliction nor sweeter balm than the lack of or possession of forgiveness from God: could each disciple but recognize the truthfulness of this fact! Psalms 32 is a good testimonial to this thought. God may bless all in many ways, Matt. 5:45, and this blessing is one of those ways, but unlike some of the others, only available to those who petition God for it.

Arguments over conditional forgiveness are brought to mind by this prayer. Perhaps the idea of repentance carries with it the aspect of righted wrongs. Certainly the person who asks God for forgiveness ought to desire to be godlike. If such is to be the case, then each disciple must stand ready to forgive in respect to relationships with others. Why is it, though, that God is expected to forgive any and all sin, but many persons consider themselves better than God since some people will not forgive sin in others, even when it is asked? Many people are like Peter in this regard, Matt. 18:21ff.

"Lead us . . ." should be the constant request to God, whether it be away from sin or into righteousness. Perhaps this petition is a bit difficult in connection with James 1:13 but an effort must be made to understand both in respect to each other. Perhaps a daily dependence on God is the end product of such a phrase, together with a request to God for the wisdom that will enable the "way out" to be seen which God has promised to provide. That God will lead wherever He deems best, keeping each disciple safe from harm and providing strength in every test so that the trusting soul may come forth as gold, Prov. 23:10b, is the idea.

The noun and the verb translated "temptation" occur often in the New Testament. Matt. 16:1; 19:3; 22:18, 35; Luke 4:13; 8:13; 22:28; Acts 15:10; 20:19; I Cor. 7:5; 10:13; I Thess. 3:5; Heb. 2:18; 3:8; 4:15; James 1:12; I Peter 1:6 and 4:12 are examples of its appearance, and provide help in understanding more exactly the idea it has.

Jesus taught that the disciple must not be ashamed to state a need, or even to ask for the best gift of all: God's spirit! Vv. 5-13 present the idea that constant prayer, to a Father Who is better than any we have known, should be present at each prayer time. Shameless requests to God are expected and no need to be afraid that useless or dangerous gifts would be given is to be felt. To ask, seek, and knock develops faith, makes each disciple do his own part, as well as examine why and what is being asked.

Place Unknown—Luke 11:14-36

"You are a wicked generation!" No wonder Jesus made this remark as we consider our text. Wonder turns into amazement and then to contempt as the scene in

our text impresses itself on our senses. Once again Jesus had performed a good deed, relieving a man of a demon and making it possible for him to lead a normal life. Yet some were so hardhearted that they asserted Jesus' power came from somewhere else than God. How frightening is the thought that we can become as willfully blind as these!

Again Jesus warned of the consequences of such a mind condition, and painted the awful picture of such persons. And when His mother was praised for His birth, He pointed out that blessedness was actually a reality only for doers of God's will. All others, though seemingly blessed, were anything but. One could not be neutral in life, even if one tried.

Signs and Judgment of This Generation

Sign seekers and unbelievers abounded as the text in 11:29-36 shows. But with such states of mind as were evident, no sign would do the job. The people here in Judea were not measurably different than those in Galilee, John 6 or Matt. 16. He reminded them of the familiar Old Testament notables and indicated that He was more to be sought and the cause for repentance than either Solomon or Jonah.

What the candle (light) is to a room and the eye to the body, is the mind to the spirit and spiritual. But if the mind is filled only by darkness, how tragic is the state of the spirit! The disciples needed to "look for" and "see" the right things in order to avoid this result, as He had pointed out in John 7:24. Note the sad state of affairs in the lives of some Gentiles because of this very thing in Eph. 4:17-19. To the one whose mind is set on following Jesus, his life can be full of light, John 8:12.

Pharisee's House—Luke 11:37-54

Perhaps it was a trap in waiting, or a mark of social status, or a good conversation piece—we know not, but despite the oft expressed attitude of Jesus about Pharisees in general, one yet asked Him to dine. But Jesus did not perform the usual rite of bathing (immersing) Himself before the meal to remove any possible defilement, and the Pharisee did the wrong thing—he allowed himself to consider such an act, and conclude it was a bad omission.

Jesus picked up the cue and revealed the real defilement that was to be feared: that of the soul. Practice and pretense were two different things, as the Pharisee well knew. Jesus taught those present that motives make the real difference. Though actions may be hiding something from others part of the time; the true self will ultimately "out." But many will be the worse for a chance meeting with such a person, for defilement is almost inevitable.

Translated into our life, it means this: we cannot fail to influence those around us, even if they are influencing us at the same time. If we are not daily conscious of our inner self, maintaining a "clean container," we will defile others, even if they are initially unaware of it. You see, graves were a means of defilement, as the law stated that whatever was touched by a dead person was also defiling in the same way the dead person was. The grave was one of those things. The living relatives or friends were supposed to mark the grave in some way so that unsuspecting persons might not be defiled by it. But a container of a spiritually dead person is harder to spot, and this was the issue about which Jesus warned.

When one of the listeners protested, He enlarged the idea, and described just how they defiled others. Jesus

knew some would think He was "insulting" (the meaning of the Greek term), but they needed a rude awakening, because they were standing under the judgment of God. Those whom Jesus described evidenced the same sort of attitude that their fathers had, who had killed others who were God's messengers. Jesus revealed that He knew of God's plan to test the generation then living, even as those before them (Abel to Zechariah probably represented the major portion of history, stretching from Gen. 4 through II Chron. 24), and the decreed punishment that was coming. And it did! He would warn of it again in Luke 19:41-44 and Matt. 23:37-39, and the Roman army would ultimately carry out the sentence in A.D. 68-70. The last verses, 53-54, penned by Luke clearly show the state of the men's hearts—no marvel that Jesus said what He did in verse 52.

Before a Multitude of Thousands—Luke 12, 13

A houseful—and then some! And time to warn about the influence of such as the Pharisees as well as to challenge those in earshot about trust in God. This great sermon which Luke records might be considered this way: 1-12, live for God; 13-34, and the right things; 35-53, and the right way; 54-59 now choose!

Living for God rather than men was a general appeal made specific by mention of the Pharisee's leaven, the knowledge of God and the issue of Himself.

One can but question why Jesus mentioned the leaven—was it because of the Pharisees' law-keeping? Their attitude? What did it do that caused Jesus to bring it up again (cf. Mt. 16:1 ff.)? Perhaps it was the fact that the practice and theory of the Pharisees differed and everything produces after its kind.

A judgment was coming in which all would be re-

vealed. The people needed to be ready for such an occasion. The self-righteous attitude must be avoided, as the inner/outer differences the hypocritical leaders had.

Fear of God must override fear of men. The man in John 9 is evidence that some feared God more than men and Jn. 12:42-43 shows the opposite. People must decide that it was better to be put out of the synagogue than heaven!

Awareness that God is a "God of little things" would fortify such a decision, so Jesus provided such by mentioning the insignificant sparrows, and the unnumbered hair on one's head. The physical body may seem mighty real when danger of death is present, but Jesus warned that eternal hell is the reality to consider! And the confession in life of one's allegiance to Jesus or men would be the crucial issue with God. Read the similar passage and identical import in Matt. 10:32-33. These passages did not pertain to a verbal confession before baptism but to a vivid profession in life, all of life. They encompassed not only what one said, but what one did—all day, every day. We too need such a challenge, that men cannot really harm us, but God has such power. Hence we matter to Him (I Peter 5:7) more than many unimportant sparrows, and with the mediation of Jesus and the guidance of the Holy Spirit, we have every reason to decide for God. Note the connection between verse 10 and 12. If one, speaking by the guidance of the Holy Spirit, was rejected as to his message, then the offer of forgiveness by means of Christ was likewise refused, since the Holy Spirit came to testify of Christ; John 16:13-14.

Living for the right things came next, and the question of the man highlighted the issue. The man really did not ask for any arbitration, but for a decision in his favor. Life did not "hang together" by what one possessed was the lesson for him . . . and us, verse 15. Covetous-

THIRD YEAR MINISTRY

ness was both foolish and hurtful, I Timothy 6:9-10, 17-19, and would blind eyes to the real treasure of God's favor. The rich fool had many things in his favor, for God was prospering him, but he was unthankful and disrespectful—and eternally sorrowful. God's idea of ownership and his did not "jibe"—to his eternal doom. He might have been successful, honorable, upright, virtuous, and many other things. But he knew death was coming for it then, as now, was 100% effective for all. Things were for him like drinking seawater—the more he had, the more he wanted. God reminded him that he had only prepared things and did not really possess them—timely, eh?

So Jesus warned again about anxious people who needed to substitute peace at the expense of material things. The rich fool could not add one bit to his life, v. 25, nor can we. Contentment with raiment and food is probably conspicuous by its absence in most of the lives of those who read this, but Paul reminds us that such should be our mental state, I Tim. 6:8, and that as we came into this world, so we shall depart, I Tim. 6:7. Most of the world then was not so minded, verse 30, and so it is today. The exhortation in Romans 12:2 is ever timely, is it not?

Verses 31-34 then encouraged the listeners to let their faith lead them, and eliminate everything that stood between them and God. Life was really a case of attraction—love would come if they would!

Therefore, living in the right attitude was a must, verses 35-53. Vigilance about the Lord's coming, both certain and uncertain, was to be the consuming passion of life. Jesus will come, His reward with Him, expecting to find every person with task finished, at peace with others and Him. Happiness was the possession of those who are ever ready for such a time. As ever, the time

of His return was cloaked in secrecy, the more to motivate watchfulness.

Peter's question really did not change the course of the sermon, and Jesus simply drew another picture to allow Peter (and us) to find himself in it. He, like others, must see that though the reckoning might be postponed, it was yet sure, and that God's time schedule was not identical with man's. Accountability was according to responsibility, verse 48, and all were punished accordingly! Though the verses in 49-53 present problems, the sum total is probably this: Jesus' life, as His coming, meant decisions must be made, for at His next coming, divisions will occur. It may then be the better part of wisdom to choose Him here, even if it causes division. His statement in verse 50 is enigmatic, and may mean that His life kindled a fire, as it were; the next act was impending, and anticipation on His part was present.

Decide now! To live for God regardless of men, material or mission. So Jesus concluded the sermon, urging people to realize they could decide (as evidenced by daily choices) and the issue was both plain enough and important enough to merit, yea, demand, an immediate, affirmative decision. Men at best had a "bad" case, and with a "storm" coming, should be urgently endeavoring to settle the issue while the time was right. If too late, there was no possible way to pay. Punishment was inevitable and in full (the Greek term mentioned was the smallest unit of money used, and equaled $1/16$ of $1/8$ of a day's wage. See Luke 21). He who has ears to hear, let him be listening!

As if some who read the sermon might wonder what decision needs to be made, Luke records the incident as found in 13:1-9. Repentance is the right decision, and thank God for the "gospel of the second chance."

Many of Jesus' day, as Job's friends, thought that

THIRD YEAR MINISTRY

calamities in life bespoke of sins (note Jn. 9:2 again). But Jesus said it was not so—and then proceeded to enforce the point with two well-known incidents in Jewish life. Thus, the lesson was given that life was uncertain and ceasation of life just as certain. God might be long-suffering, but the last chance will come for one and all. Uselessness preceded disaster as surely as God was alive. The unrepentant will suffer loss of well-being just as certainly. Can you discern the signs of the time?

In a Synagogue—Luke 13:10-17

An ox for a woman! Few would, in Jesus' day or even now, really have been willing to say an ox was actually of more value than a woman, yet when closely examined, some thought so even if they would not admit it.

Our text presents some people who fall into such a category—as we shall see, Jesus pointed out that some men would water an ox on a Sabbath day, but would not allow a woman to be healed. The problem stemmed from interpretation of a Sabbath law, which they had falsely construed. Perhaps the men would have been more excusable, but when their fallacious thinking was exposed, rather than rejoicing in the new freedom Jesus offered, they reacted adversely.

The woman had a long standing problem, and Luke used an old medical term for curvature of the spine to describe her trouble. She apparently could not straighten herself up. Jesus, in effect, considered her deplorable state and freed her from it, much as a man might free an ox from a stall to permit the ox to be watered. While she was praising God, others did not share her joy: the ruler of the synagogue specifically. He became in much pain

(the meaning of the Greek term) and addressed those present, expressing his personal dislike regarding the act, as if the woman had come to be healed, and Jesus had done so, expressly to "break the Sabbath." Jesus knew the remark was made for His benefit, so He responded with the idea that no one felt the Sabbath was being broken by doing necessary things, even for a dumb animal. If this was so, how much more ought a person loved of God be relieved of Satan's bonds. The conclusion drawn by some was this: God's command about the Sabbath is important but our interpretation and application of it is wrong. God meant for the Sabbath to be a blessing to us, not a burden. He (Jesus) is trying to show us God's design for it. Praise God! And they thought rightly. God meant it to be used in regard to what was best for body and soul, and "rest" was not the main point at all. However, others were simply chagrined and not convinced. Thus it ever was. One can see why Jesus was rather plain spoken, as in Matt. 15, Mark 7. So many needed a spiritual "loosing" and so few who would even step aside so that those who desired could enter into freedom, 11:52 and Matt. 23:4.

The parables of the kingdom, the mustard and the leaven follow in the next verses through 21. It is difficult to tell whether Jesus just tacked these on because of the healing or if the healing interrupted the discussion which included these. The two familiar parables (Matt. 13) described the spread of the kingdom as to its great potential, and the power of the kingdom, so quiet and secret, yet so surely and ultimately noticeable.

Feast of Dedication—John 10:22-39

The close of this three month period found Jesus late in December at Jerusalem. The Feast of Dedication

drew some people into the city, and perhaps some of these were among those who pressed the issue about His identity, v. 22. These were not different than those in Luke 12:54-57 in that they could discern the signs of everything except the ones Jesus was working. Had they been observant, the works done by Jesus would have told them the answer to the question they asked. The gist of their trouble: a bias of mind with a veil over the truth. They were not following and volitionally so. Jesus explained that His identity was plain to those who willed to keep listening and following Him, and to all such, He Himself gave eternal life. Not only so, but they would enjoy the protection of both Himself and His father. The implication of this was that He and the Father were equal, and working together. (Note Jn. 17:11, 22, 23 for texts on the idea of "oneness"—the Greek texts are the same.)

His auditors immediately drew the conclusion that He was claiming deity. As before pointed out, rather than correcting their impression, He reinforced it. He pointed out that their law (Psalms is thus a part of that subscribed as law) had labeled others (judges whom God had appointed) as god(s) and they did not object. Why should they object if He also claimed to work with and for God? And if He was, then let the chips fall where they may. The issue: either deny the works, or believe.

So the issue was closed, as He evaded the arrest attempt and left for three intensely active months in the Perea area across the Jordan, away from Judea and Jerusalem. When He returned to Jerusalem to stay, they would crucify Him within a week, and mankind's degradation would be indelibly etched in space and time in the crucifixion of the Lord of Glory. The real-life drama was rapidly drawing to a close.

LATER PEREAN MINISTRY

Perea—John 10:40-42

This brief note by John causes us to switch our attention to the east side of the Jordan, which was less densely populated and more of cattle country, Num. 32:1-5. Jesus relieved some of the pressure as just experienced in Jn. 10 by going there, and also placed the next three months of ministry somewhat in the land over which Herod's son, Phillip, ruled. Phillip was not as troublesome as others were, and Jesus' ministry hindered less. Hence, it was so that many followed Him, and some were willing to accept John's testimony concerning Him. John had not lived or died in vain!

Cities and Villages in Perea—Luke 13:22-35

"Who's saved" has ever been, we suppose, a piquant subject. Doubtless many had wanted to ask Jesus this question, and Luke treats us to His answer for it. Not unusually, He allowed the auditors to draw their own conclusions. The door is too narrow, He remarked, for some who would attempt to enter it. The indifferent, unworthy, and half-hearted could not get in. No unregenerate or unsundered would make it, we venture to guess. If one desired to enter, there was no time like the present, for the door was (and is) open. But it would shut some day, and opportunity closed. Quality was important—one must agonize (it required death of self to enter then, and now) to get in. God, like the householder, had His stated requirements for those who entered. Feasting, the common Jewish concept of the kingdom, was the order of the day for all who qualified.

Those who failed—what brought about their rejection? Apparently fellowship was not enough to provide

MAP NO. 6—THIRD YEAR, LATER PEREAN MINISTRY (about 3 months)

1. Feast of Dedication, Jerusalem; attempts to kill Jesus; retires to Bethabara (place of His baptism), Jn. 10
2. Perea; journey through cities and villages; few saved, Jn. 10
3. Home of a Pharisee; rules for feasting, Lk. 14
4. Place unknown; parables of lost sheep; lost coin; lost son; Lazarus and Rich man; Lawyer's question, Lk. 15 & 16
5. Receives call to come to Bethony; raises Lazarus; Jews seek to kill both, Jn. 11
6. Retirement to Ephraim with 12 disciples, Jn. 11
7. Journey through borders of Samaria; Galilee, Perea; heals ten lepers, Lk. 17
8. Sermon on time of Kingdom; teaching on Divorce; little children; Pharisee and publican; rich young ruler; parable of laborers in vineyard; plainest prediction of crucifixion; James & John seek chief honors, Mt. 19-20, Mk. 10, Lk. 17-18
9. Jericho; two blind men healed; Zacchaeus, Lk. 19
10. Parable of Pounds near Jerusalem; 4th Passover night, Lk. 19

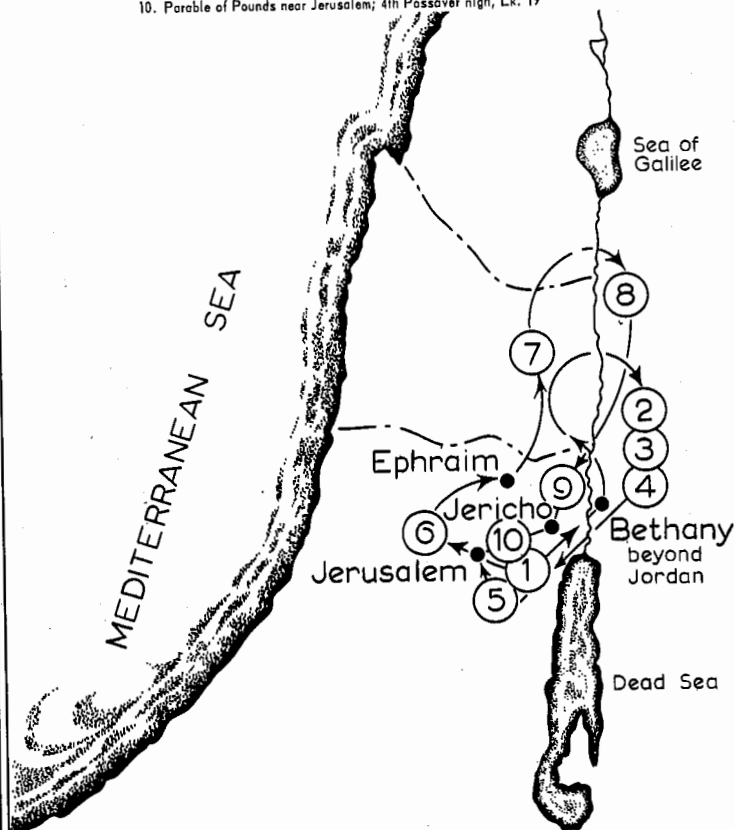



NEW JERUSALEM -- as rebuilt

THIRD YEAR MINISTRY

the ticket. God did not love the world enough to save it in its sinful state then or now, but demanded compliance of any or all.

Jesus apparently shared with them (and us) the idea that faithfulness was a vital quality, as He lists those who were sure to be there: Abraham and others. He also noted that some would expect to enter and would not, v. 30 (note our comments on a like expression under Matt. 19:30). For those who so thought, intense sorrow would be part and parcel of their existence subsequent to rejection. No annihilation for those refused!

Concern was manifested on the part of some Pharisees for Jesus as they brought news of Herod's design on His life. In response to their warning, Jesus gave a rather enigmatic (hard to understand) answer. He knew that Herod was treacherous and sly, caring only for himself (see ch. 23:6-12). But the following remarks about His ministry are the difficult ones. The expression "three days" had varied usages then as now. It might have meant literally three days, or an indefinite time, a long time or a short time, depending on the context in which it was used. It seemingly means a rather definitely indefinite time, known to Jesus. Therefore, He was not too concerned that Herod sought His life, as He knew the course of the future. For that matter, Herod was not the only one seeking His life. As He pointed out, somewhat in irony, but nevertheless truthfully, Jerusalem was to have the "honor" of taking His life, even as it had done to others in the past. The reference was not to be taken as accurate, but, as stated, was said in irony, for John the Baptist had perished outside of Jerusalem. The likely intent of what Jesus said is that the people, typically represented by Jerusalem (see Gal. 4:21ff. as an example), had a sad record of refusing God's messengers and bringing about their death. So it was to be in His case also, and

He knew it. And this despite the oft repeated efforts to change their hearts, not only by Him, but others. Hence, no longer would He shower His blessings exclusively on them, but would include any or all who so desired. Thus "seeing" would henceforth be dependent on "saying."

The reader might note that the synoptics do not record any such ministry by Jesus in Jerusalem as this text implies. The value of John's gospel is made clearer by such references as this. The same sort of idea was noted in the reference of Jesus to His ministry in Chorazin, Bethsaida and Capernaum—and the same results, too! Reference point 29.

Home of a Pharisee—Luke 14:1-24

"He took our infirmities"—how often Jesus fulfilled this prophecy, Isa. 53:4 (see Matt. 8:17). The recipient of His compassion was suffering from some condition better identified by its effects than its cause. Dropsy is descriptive of a person whose body retained excess fluid because of a condition that might indicate a disease of the heart, liver, kidneys or brain. It comes from a word derived from the Greek word for water. The condition was cured by curing the cause.

"Is it lawful?" "Yes, it is!" So one more Sabbath was highlighted in the ministry of Jesus because of a miracle worked (see list of Sabbath miracles under John 5). Jesus repeated His contrast of the ox versus a human being, and gave again the answer that a man was worth more. How very often self-interest determined attitudes! It made much difference, anytime, "whose ox was gored." Could the people of Jesus' day see where their interest ought to lie by Jesus' example? Can we?

Continuing the lesson, Jesus had noted how the people who attended the meal had reckoned up (meaning of

THIRD YEAR MINISTRY

Greek term) the place they chose to recline (no one sat in chairs in that culture, but rather reclined on mats or something of like nature). Some had apparently considered themselves worthy of the best seats, because that got the emphasis from Jesus. The better thinking, He said, was to consider oneself unworthy of any but the lowest, least ostentatious mat. If then the host wished to elevate one in the "social standing" of his home, the person so honored would be glad of his initial choice. But should the reverse action take place, how chagrined one would be. Solomon must have encountered such problems in his society, too, for he wrote, in effect, that pride would precede shame and disgrace, but humbleness of mind evidenced right thinking, 11:2, 16:18. Especially was it true where God was concerned, and even as the hypothetical host, each would be rewarded according to merit, v. 10-11.

Lastly, Jesus said, the host who was really with it would invite those who could not return the favor, v. 12-14, for God would repay such a man later. Perhaps the text in Matt. 5:44-48 should be reread at this point.

The thoughts that such teaching started in motion were doubtless varied, but the statement of the man in v. 15 might give evidence that he expected to be at the banquet in the kingdom. If so, he was duly treated to an account that should have awakened him to the distinct possibility that all who thought they were going to be in the kingdom might not be.

Jesus spoke of a certain man whose banquet table was prepared. To those who had previously been informed that a feast was in the offing (such was the common oriental custom of the day) the man sent his servants to inform such that the time had arrived, come to the feast. Much to his surprise, excuses amounting to insults were proffered, and the summons refused. Rebuffed, the host

directed his servants to fill the feast with others who were willing, and the insolent erstwhile guests got ignored.

The insulted host represented God. The first guests the Jewish nation. The excuses were really that. The field and the land would have waited, and the Jewish law made a newly-married man pretty much free to accept such invitations with his wife, Deut. 24:5. Such were the caliber of reasons God was getting for His kingdom table. Once again Jesus left His auditors with a brain teaser, attempting to challenge their thinking in respect to God. Diligent efforts were to be made that God's invitation might be honored. How costly excuses might become if God were turned down!

*Before a Great Multitude, the Cost of Discipleship—
Luke 14:25-35*

In the same vein, because many had reason to evaluate themselves, Jesus issued a clear-cut description of those who would be classed as His disciples. Much was in store for those who chose to follow, but the cost was proportionate. It cost all, renouncement of life and everything in it, verses 26, 33 (as in Matt. 16:24-26; Phil. 3:1-14). No other quality of character was worth even fooling with, v. 34-35.

Essentially, discipleship involves two distinct phases, each separate and yet intertwined. There is the mandatory process of *counting the cost* of it versus the cost of anything else. Is choosing something other than discipleship worth the cost? Then, the equally important consideration in *planning to finish* what one starts, lest the initial action be a monumental catastrophe. It is not less important to finish than to start in respect to discipleship. God will be genuinely unhappy with any or all who start and become disenchanted along the way. Thus the Scrip-

THIRD YEAR MINISTRY

ture often warns, as in Luke 9:57-62; Heb. 10:37-38. For the person who so lives, he is as detestable as salt no longer NaCL, (chloride of sodium).

Place Unknown—Luke 15, 16 and 17:1-10

Sharing the success of another without some jealousy is a difficult thing for most people. Seemingly it was so in respect to Jesus and the Pharisee/scribe combinations in His day. As the Perea tour saw great numbers of people attracted to Jesus, they cast aspersions on His character by downgrading the company He kept. Such attitudes produced one of the loveliest passages in the Bible depicting the love of God for people, even those who were lost, then continuing with the only commendable thing in life, the way to avoid being "found," and a real life illustration of the ultimate end of both the righteous and unrighteous.

Luke's Chapter 15 is the section of the sermon that portrays in various ways God's love for the lost. The shepherd is God, unwilling that even one be lost, though many others are not. The woman is God, unsatisfied with less than a "clean sweep" in the attempt to find the lost. The father is God, unable to cease caring and waiting for the return of anyone lost. Many are like the younger son who felt that he had the right to do his own thing. The world has ever seen this type of individual, beginning with Adam and Eve. The attitude that God is not needed in life is the prevailing one at any given moment in history, we suppose. Yet, as with the father, the son was allowed to make his own choice. Nothing else would permit a human to remain that, since if that possibility is removed, the ability to choose for God is likewise gone. The elder son, however, is the other leading character in this part of the sermon. The younger son symbolized the publicans

(tax collectors) and sinners in whom Jesus showed interest. The older brother symbolized the Pharisees and scribes who resented any concern for anyone but "righteous" people like themselves. One recalls the remark of Jesus in Matt. 9:10-13 on another occasion similar to this one. He not only did not care about his brother, he did not care about his father either! How very much unlike his father he was. I John 4:19-21 flashes into view as we meditate on his thought process. If we do not love the lost, how are we like our heavenly Father? Why was it that the older brother refused to share in the feasting, verses 25, 32 and the joy, verses 7, 10, that surely could have been his? Do God's children today ever manifest the same sort of indifferent attitude this man did, even when another of God's children "comes to himself," and returns in body and mind in repentance to the heavenly Father?

Point two of the sermon finds Jesus relating an illustration of a certain man who had one feature Jesus expects to find in everyone. That feature was the virtue of using the present to prepare for the future, or, stated a different way, preparing in this life for eternity. The rest of the illustration was only to highlight this aspect. The unstated but obvious reference was to the publicans and sinners who actually were trying to find the way to life eternal (note here Luke 12 and Matt. 21:28-32), versus the Pharisees and scribes who were not.

In fact, the next verses, 10-18, are descriptive of these last mentioned. They were not faithful in their use of what God had given them, the "unrighteous" (the Greek term probably implies no inherent value of its own) mammon. Since this was the case, God was not going to entrust them with anything of real (the true riches) worth. Right to form, those to whom this particular point applied scoffed, which immediately revealed that He had accurately appraised them. He completed the indict-

THIRD YEAR MINISTRY

ment with the statement in verse 15. The remarks about the kingdom and divorce seemingly developed the thought that such men as these had been attempting to handle God's kingdom to suit themselves, and, as a specific illustration, had disobeyed God's will in the matter of marriage, divorcing and marrying as if God had revealed nothing along this line at all. We can not but wonder if those listening realized that Jesus had just informed them of ways to get lost: all of which could be described as disregarding the future by disregarding the present.

Conclusion: your choice in this world determines your reward in the next world. The reality of the present is only understood accurately when compared with its relationship to the future. Then Jesus finished this sermon by underscoring the following: 1) the future world is real, 2) how we live here (our environment is not the deciding issue at all) determines how we live hereafter, 3) which existence is eternal in respect to everyone, 4) the future existence is every bit as actual as this one, as consciousness in all of its facets will be ours. To state it another way, personality never ceases (which is saying that all live forever). Further remarks about this specific point are made in discussion of # 72 (6).

Note that the rich man evidently failed to heed God's will for him, and his physical death ended his chance for heaven (do you understand better the meaning of John 3:36 now?). Another lesson taught is that God expects any or all to obey His revealed will for them (note here Romans 1:31-32; 2:14-15) and will not do anything special for anyone. Some have taught through the centuries that unless God in some way activates a person, he will not want to become a Christian. That is how the devilish doctrine of the mourner's bench and "praying through" came into existence. God alone knows how many people are in hell because someone told them they

could not accept Christ until they had had an emotional experience from God, and because they never could get such, they became discouraged and turned back to sin. Abraham had his facts straight when he remarked that the brothers yet on earth had enough of God's will to make the right choice. Christ died for everyone, and left the New Testament to tell men how to accept His death. That is God's part. Our part is to accept Christ. It is just that simple. It is pertinent to remark that a resurrection does not necessarily convince anyone of anything. Note the text in John 11:45-53 and Matt. 28:11-15.

Luke 17:1-10 presents one of the most interesting texts in the Bible. Jesus taught some very basic lessons about the nature of man, relationships to others and about the faith life.

Consider the first sentence: Causes of stumbling are inevitable. This expression has meaning only against the backdrop of man's power to choose. Such characteristic, in relationship to the subject of sin, makes man a moral being, and unique of all God's creation in this respect. All else that God created acts without the moral realm, hence sin is no factor in any existence but man's. Obviously, the ability to choose (ability, power, right—all of these or any other words of similar impact stem from the basic idea of freedom to choose. In the text in John 1:12 and Matt. 28:18, the word translated power or authority basically carries the idea of freedom, thus right, power, etc.) would presuppose something to choose. The failure to so live in due respect of such responsibility results in sin. Therefore, anything God created should be considered in this light: here is something that may either be used or misused (the chance to "stumble" is present).

If such be true, then the explicit relationships of one Christian to another in the text must be considered with this in mind: If opportunities to sin are ever present, then,

THIRD YEAR MINISTRY

1) each Christian must ever be alert to forgive or ask forgiveness, as sin is likely to occur, and 2) each Christian must treat others as they wish to be treated, Matt. 7:12. Too, since one of the basic facts of the disciple's existence in relationship to others will be that one might seemingly urge the wrong rather than the right in some way, each must always allow faith to lead, and minimize any such possibility. This is so, not only because of the hinted-at punishment in verse 2, but because each knows the possible destiny of people who die in the wrong relationship with God. Each disciple must constantly avoid the sin of causing others to sin! To this extent each becomes a "brother's keeper," Gen. 4; Romans 14:1—15:13; I Cor. 8:1—11:1.

Verses 3 and 4 highlighted the duty of forgiveness. The disciples were admonished to take heed in regard to self, and also to their brother. If sin occurred in a brother's life, the consequent responsibility was to rebuke him for it. It will be worth the space to ask you, dear reader, what your idea of the word "sin" is. As Jesus used it in this context, what frame of reference did He have? Whose idea of sin did He mean: anybody's or as God defined it? Note next that if repentance was produced (which was the *object* of the rebuke, as in Matt. 18:15) then each disciple must forgive the brother who sinned when he asked for it. If they did not do so, what sort of Christian would they have been? Would they, unwilling to forgive, have become an occasion for stumbling? By the way, was sin the transgression of a command? If so, did Jesus command them to forgive? In this connection, verse 4 instructed them to the effect that they might have to forgive more than once (Jesus implied without limit in Matt. 18:21-35).

How is your faith by now? Any inclination to give up and get out? If so, what sort of occasion to stumbling

would that be? Perhaps the same reaction that was the apostle's is yours: I need more faith (than I have)! Sorry, no relief in sight. Jesus promptly taught that even a minute amount of faith could do seemingly impossible things, verses 5-6. And to keep the pressure on, He then reminded them that even if they did all that had been commanded, they were only doing what they were supposed to do, and had no ground to request something special. Such was ever the faith life.

Bethany—John 11:1-53

"Time waits for no one, it passes you by; It's just like a river, flowing out to the sea." Thus did the song writer describe what happens to all finite things. Time tests everything, and the inevitable occurs: decay, disintegration, breakage, death. Yet, so often people treat such facts as did the rich fool of Luke 12—as if they did not exist. What fools we mortals be!

The preceding paragraph was intended to do this: help each one realize that Christ in one's life changes death from a tragedy to a triumph. As evidenced in the rich man of Luke 16, death does not change character at all, nor destiny hinged on that character. What we are at death, we remain, insofar as our relationship with God is concerned. God may or may not permit the prolongation of our earthly life, but demise is yet certain. Man is appointed to death, God has decreed.

Whether anyone ever died or not in the presence of Him who was life we do not know. But at least one whom Jesus loved died. His name: Lazarus. While Jesus was yet in Perea, Lazarus became ill (whether of a disease or old age, we know not) and his sisters sent word to Jesus. He remarked, upon learning of it, that the illness was not in the direction of death, but in behalf of the

THIRD YEAR MINISTRY

glory of God, verse 4. We call this statement to your attention because of the use of the word "death" by Jesus. The reader should call to mind what that word means to him in its common usage. Having done so, pursue its meaning on the lips of Jesus, especially in this text; Luke 7; Matt. 9, Mark 5 and Luke 8; and Matt. 22, Mark 12 and Luke 20. Note, in addition, that death (Lazarus did actually die, as we understand the word) could be a means to honor God.

"Jesus loved . . . but He stayed." The ways of God are often paradoxical. Did Jesus tarry in Perea two days after the reception of the message because He had less love than the sisters thought? or because He had something better in mind?

However, He decided to go, and announced it to His disciples. They were understandably upset at this, because the intent to kill Him was well known, and rather strong, building up even from the first Passover, John 2. Responding to their question in verse 8, He remarked in verses 9-10 about one walking in the day, and the confidence possessed in the sunlight hours. This seems a bit enigmatic (the meaning is rather obscure), but we understand Jesus to be saying that He was like the man: He knew what he was doing because He was able "to see."

However, the remark in verse 11 was just as obscure, and the puzzled disciples so indicated. "Why walk all those miles just to awake Lazarus? (They were thinking: He will awaken long before we get there, so what gives?) For the reader, what use of the word "sleep" did Jesus make here? Was it equal to the meaning of the word "death" and vice versa? The disciples then were told that Lazarus was, in their language, dead. They thought the trip to Bethany was so dangerous that Lazarus would not be alone in death, but their courage was not lacking, even if their understanding was.

Pausing just a moment to remark on this section, we posit the following idea about the use of the word *sleep*, leaving the major discussion of the state of the dead until # 72 (6) and the section of Selected Studies. We believe that Jesus' use of the word means that our whole understanding of death is wrong. Man has seemingly never really understood the concept of what he himself is: a spirit being living in a mortal, fleshly container. This container, subject to the laws of all finite things, wears out, if other circumstances do not happen to shorten life. God has so ordained a plan for human beings that when such time occurs, the real being, the spirit being (the real you) goes back to God Who gave it, the body to the dust from whence it came. Hence, to God, the person never ceases to exist as personality.

For us, the description of a personality in sleep means they are very much alive, simply in a particular state of life we call sleep. Such is the real case, then, with death. To God the personality we call "dead" is not so at all. Note that Jesus addressed the widow of Nain's son, Jairus' daughter and Lazarus as if they could hear him without any problem at all, which they could and did. To God, they were not dead. We need to consider God's usage of the term "death" and its derivatives and adjust ours accordingly.

Arriving at the town of Bethany, the party learned that Lazarus had been dead four days, probably having been buried on the day of death if possible. As was the custom, the family was still in mourning, perhaps with professional mourners yet present.

Learning of the arrival of Jesus, Martha went to meet Jesus, and the ensuing conversation is both thrilling and enigmatic. Martha's expression in verse 21 is one of the last. Did she think, as did the official in John 4 and Jairus that Jesus' power ended at death? Verse 22 is much the

same. Is she dropping a hint that perhaps the prayer of Jesus would avail something for Lazarus?

When Jesus replied with a statement that could be understood at least two ways, she responded with her understanding of how it was to be in the future with Lazarus. It is pertinent to remark that the Old Testament taught but little in the way of resurrection. However, we do not know how much the people understand about the future life, nor how much they might have been taught, by others or Jesus Himself. Much is implied in John's preaching as recorded in Matt. 3:7-12, and it was a cardinal doctrine of the Pharisees, Acts 23:6-8. Jesus taught considerable about the future life, and the sisters had doubtless heard some of that.

The expression of Jesus in verses 25-26 is certainly one of the most familiar of any Bible text, and truly one of the most cheering. However, does verse 26 repeat verse 25 in slightly different form, referring exclusively to the spirit of man rather than the body as in verse 25, or are the two verses to be understood in slightly different ways? Does verse 25 teach that the cessation of life in the physical body is but for a time, while verse 26 refers to the status of the personality who trusts himself to Jesus, and receives as a reward the quality known as eternal life?

Jesus plainly taught that His relationship to life was such that He was life; that the whole idea of the resurrection was from Him insomuch that He was the resurrection. John's gospel often records similar ideas, not only that Jesus was the giver of life, as in 1:3-4; 5:21, 24-29; but that He was the water, the bread, the truth, the way, etc. Such realities are aspects of Jesus, Who is our wisdom, righteousness, sanctification and redemption, I Cor. 1:30.

We should not pass over the importance of the tenses Jesus used here. The values to be obtained in and through Him are contingent upon a continued life of trust, espe-

cially as is promised in verse 26. Note the same sort of conditional idea in 3:36 as both the expressions "the one who believes" and "the one disobeying," (or "believeth not" as in the King James Version) translate present participles, implying a continual state of affairs. 5:24 is another sample of the same thing, and so is 10:27 where the Greek verbs translated "hearing" and "following" carry the idea of habitual discipleship. There is no life but in the Son, I John 5:11-12, and anyone must habitually be in Christ even until the point of death, Revelation 2:10b, to procure what Jesus has to give.

Whether Martha understood all that Jesus said or not is doubtful, but she knew whatever He did would be right. Might all who read this be likeminded. Her confession in verse 27 was made under more trying circumstances than Peter's some three months earlier, and is equal to it in every way. The "coming one" was the subject of prophecy (Matthew 4:1) and she believed it had been fulfilled. The Greek expression is the same as in John 1:27 and Matthew 11:2, "the one coming."

Martha departed to bring Mary, intending to do so without others following along apparently. But when those with Mary saw her leave, they followed, and were treated to the miracle of the resurrection of Lazarus.

Mary repeated Martha's expression of verse 21, and Jesus began to more fully share their sorrow as well as expressing His own feelings over the incident. All who read this ought to be aware of the fact that God can understand the deepest sorrow. Yes, He understands, and cares, doubtless even more than we do.

Whether the Greek terms of verse 34 describing the feelings of Jesus can be fully understood by us or not, they surely indicate that Christ was more than just a passive onlooker. Those who observed Him weeping rightly interpreted His tears as a sign of His concern. Some, as

others, had not forgotten another cure (John 9) some six months earlier, and so remarked about it, though sharing the common view that His power to help was ended by death.

When Jesus arrived at the tomb, He directed the stone to be rolled away in preparation for the next act: resurrecting Lazarus. From the description of the tomb and the fact that Lazarus was able to come out, we assume a tomb of such a nature as to permit movement by people inside of it, though whether the tomb was in a hillside or cave is impossible to decide. The tomb in which Jesus was buried was large enough for people to go inside of it.

Martha's faith was strong, but so was the reality of her dead brother. She did not think beyond the corpse, as her remark indicates. But Jesus was not hindered by her unbelief. In fact, the miracle did not depend on anyone except Jesus Himself, as His prayer indicates. Having audibly expressed His thankfulness to His Father, Lazarus was commanded to come out. Having obeyed, the clothes which bound him were removed (did they contain spices as the common custom was?) and Lazarus was a part of Bethany again. The fact that we have no record of his experiences while "dead" is at once remarkable and intriguing. The explanation of Paul about his experience in II Corinthians 12:2-4 is not any more helpful. The only real glimpse of the affairs in the next life, other than what can be gleaned in Revelation, is that of Luke 16:19-31.

That Jesus knew the whole affair from beginning to end is evident from verse 15. We hence conclude He also knew about the results, even the one prophesied in verses 50-51.

As remarked on Luke 16:19-31, a resurrection does not necessarily make anyone a believer, though it adds to their opportunities and also to their culpableness. Some went away believing in Jesus. Others went away planning

not only to put Lazarus to death again, 12:10-11, but also Jesus 11:46-53, Who raised him from the dead, simply because, as Pilate observed in Mark 15:10, the men were envious of Jesus.

As John wrote the remarks of the council for us to read, one can not help but note the false ideas of the kingdom they held, verse 48, nor the selfishness they manifested, such as in the ironical statement of Caiaphas, who had held his position eighteen years, about Jesus, Who would be offered that fateful year as the one real sacrifice for sin. He was critical of the council because they did not "reckon up" (meaning of the Greek term) the total picture correctly. However, Caiaphas became a prophet for God quite unknowingly, as John shows.

Ephraim—John 11:54-57

Jesus immediately departed from there because of such thinking. He apparently did not go back to Perea, at least for a little while.

The Passover being near, those coming for purification talked among themselves about the definite possibility (to them) that Jesus would not even attend the feast. How little they really understood Him.

Purification was needed for several things, such as contact with the dead, Numbers 19:11-22; leprosy, Leviticus 13, 14; birth, chs. 12, 15; contact with unclean animals, ch. 11, Deuteronomy 14; or even physical faults, or murder, as in Leviticus 21 and Deuteronomy 21.

A Trip Through Samaria, Galilee and Perea to Jerusalem—Matthew 19, 20; Mark 10; Luke 17, 18

This extended tour will bring to our attention several subjects of interest, among these leprosy, prayer, marriage and divorce. At the close of the tour, Jesus will

still have many followers, and will arrive at Jericho to begin the twenty mile walk to Jerusalem where He will be crucified.

"Unclean" "Unclean"—the cry was often heard by people of that day, because those who had any of the variety of skin diseases labeled by the general term "leprosy" were required to so notify anyone within earshot. As with Matthew 8, we will advise the reader to peruse the special study on leprosy. We would note in passing that the term used in the Bible does not mean the same thing as we use it to mean today at all. Read Leviticus 13, 14 for yourself. Even garments, 13:47ff., and houses, 14:33ff., could be afflicted with "leprosy" as the Bible uses the term.

The ten men had in some way contracted any of several surface afflictions of the skin known as leprosy. The common procedure was to isolate such a person from the community, with the person wearing a torn garment, bare head and wearing a cloth over the lower part of the face. Whether all did this or not is unknown to us. Sometimes the skin affliction was seemingly incurable, but sometimes cleared up itself. If the person became completely covered, he was pronounced clean, Leviticus 13:13. See Leviticus 14:1ff. for the cleansing ritual lepers were to follow.

"Mercy!" "Have mercy on us!" Just what the men might have meant by the term "mercy" in another context is unknown, but they knew what they meant here, and so did Jesus. As usual, He directed the men to obey the law, and show themselves to the priest. This command is all the more interesting since one of the men was not acceptable to a Jewish priest, as he was a Samaritan. As the men obeyed, and went their way, the leprosy left them. Such healing is instructive in that the men did not question the command, but in their obedience

were healed. In this sense, obedience equaled faith, as it normally does in the Bible.

Whether the men proceeded on to the temple in Jerusalem or not is unknown, but one of them, the Samaritan, returned to give thanks to Jesus. Christ knew that all ten had been healed, and makes a point of telling others about it. We can but remark that such was typical of the whole Jewish nation, and had been for centuries. They were personifications of thanklessness and ingratitude. Note the following texts, out of many, which bespeak of their general attitude: Matthew 3:7-10; 15:24; 21:33-41; Luke 11:29-32; and Romans 10:18-21.

(2) The sermon about the kingdom in Luke 17:20-37 is instructive in several ways. Jesus seemed to pass by the question asked and gave some detailed facts about His second coming. He remarked about the nature of the kingdom that it was not a revolution outwardly, but a relation inwardly. The remark about being able "to observe" signs translates a Greek term used in the medical world, in respect to watching for symptoms of a disease. The essential nature of the kingdom was internal not external. We know the church (equal to the kingdom) is like that: a relationship to Jesus that is only outward in some ways, and is essentially a spiritual kingdom, since its king and subjects are spirit personalities.

Let us consider what Jesus did say in response to the question:

1. He will not come when desired, v. 22
2. What way He will not come, v. 23
3. What way He will come, v. 24
4. What must happen first, v. 25
5. World conditions at the time, vv. 26-30
6. Correct attitudes about things of the world, vv. 31-33

THIRD YEAR MINISTRY

7. Things that will happen at the time of judgment, vv. 34-36
8. The time of His coming and judgment, v. 37

Notice the fact that God has set the time, v. 37, and nothing will change it. So the *fact* of the coming is certain, though the *time* and *circumstances* largely unknown. The major emphasis then would be about the personal reckoning at that time, and the imperative to be ready.

Two items of interest: one is that the historicity of Noah and the flood is certain, as is that of Lot and the destruction of Sodom and Gomorrah with the other two cities of the plain. Secondly, the Greek term translated "eagles" in most versions would be better translated "vultures" as eagles are not birds of carrion while vultures are. (Note the similar discussion in Matthew 24-25; Mark 13 and Luke 21.)

(3) The teaching on prayer and the two parables told in connection with it are perhaps more familiar to most people than the text in Luke 17. The emphasis is on the one imperative in life: faith in God. Trust that God will do the right thing at the right time. To state it a different way, trust in the total character of God is the basis for prayer, or any other facet of the believer's life.

The parable teaches that we are to be always prayerful, in the sense that we never fail to ask our heavenly Father for that which we need, and never doubt that His answer will not only be forthcoming but will also be the right one. Such an attitude of prayer will not count any supposed delay as indifference or ignorance, but rather will assume that God really cares for His own (in contrast to the judge who cared nothing for the woman, or anyone else either, v. 2, 4-5) and the "delay" is for our own good. His very character "holds Him in line"

whereas the judge had no such restraining influence. He will always do the very best for His loved ones.

Perhaps a word or two used in the parable is of interest. The word "vindicate" used in most versions in v. 3 is hard to understand. Did she mean "protect me" or "right the wrong?" It occurs in such texts as Romans 12:19; II Corinthians 10:6; Revelation 6:10 and 19:2. The idea of "always prayerful," or whatever your version uses in v. 1, is a translation of a Greek construction underscoring the idea of the vital necessity to pray. The idea of "wear out" or "weary" in v. 5b translates the same word Paul used in I Corinthians 9:27 as he described his efforts to keep control of himself.

The Pharisee and the publican are the next examples of prayer life, two clear photographs of the attitude about self in relationship to God, whereas the first parable concerned the attitude about God Himself.

Treating others as nothing is the actual end of despising them, and this sort of thinking is ungodly, as is the companion idea of self-righteousness. Neither make answered prayer a very great possibility.

The Pharisee did not exactly say so, but his underlying idea is that God would have been destitute of servants if he had not been alive. His utterance expressed thankfulness, though not for mercy (did he think he really needed any?) but rather that his life was equal to the law's demands. He reels off a list of people he is unlike, such as extortioners, Luke 3:13; unjust, Matthew 23:13-15; adulterers, Luke 7:36-50; or (climax of all iniquity!) *this tax-collector*. One can but wonder, as the prayer goes on, if he thought God owed him something! The law required only one day of fasting per year, the day of Atonement, but the Pharisees added two per week between the feasts of Passover and Pentecost, Tabernacles and Dedication. Do you see better why Jesus talked

about fasting in Matthew 6:16-18? Needless to say, his sort are sometimes noticed in the church as surely as the fact is true that grace does not produce such characters!

"Justified!" This was the verdict of God that day—however it was not a description of the Pharisee (do you remember Luke 12:1?), but of the forgiven publican. So Jesus passed the sentence on two types of lives, one to abhor and the other to mimic. The fruit of each life was glimpsed in the prayers uttered. The publican did not brag, nor preach, nor do aught except confess his need of God's grace. He got it. He stood afar off, perhaps not even in the outside edge of the men's court, but in the court of women or even farther away in the court of the Gentiles. He had eyes only for himself, and expressed the idea that he was *the* sinner, if ever there was one. His request was only for mercy, which God graciously gave. Success!

One remark about a Greek term used by the publican. It is a bit hard to translate in the verb form which is in our text, but is found in such passages as Romans 3:25; Hebrews 2:17; 9:5; I John 2:2 and 4:10 in the idea of propitiation. The idea involved is that of making the relationship between himself and God right again.

(4) The text now at hand is found in Matthew 19 and Mark 10. The opening verses of these two chapters indicate movement sometime prior to our texts of 19:3-12 and 10:2-12. The texts in Matthew 5:31-32; Luke 16:18; Romans 7:1-6; I Corinthians 7:1-16; Ephesians 5:22-33; Hebrews 13:4; and I Peter 3:1-7 are to be considered in relationship to this text.

Whether the Pharisees had sinister motives in their "test" question or not, Jesus gives the most elaborate answer about marriage in the Gospels. He first pointed out that He, as a part of the Godhead, had intended that from the beginning of time the marriage state was to be

the normal state of male and female adults. Anyone who wished could make himself or herself as a eunuch in behalf of the kingdom, vv. 10-12, but this was by free choice, not command. Paul notes as much in I Corinthians 9:5. Thus He does not command divorce at any time, only permitting it (and that permission was only necessary because men's hearts were obstinate to God's will in the matter, as v. 8 and Ephesians 4:17-19 show). As He notes, the only command He gave Moses was in respect to a bill (writing) of divorcement, not to promote divorce. Forgiveness is to take place in a marriage problem, rather than divorce, which is simply a means of running away from the demands of marriage rather than facing those demands. The texts in 18:21-35 and Luke 17:1-10 are important in this respect.

Hence, the question of the Pharisees really did not get to the crux of the matter. The issue really was, not is it lawful, but rather is it godly (what God would do)? The question also pointed out another age-old idea, that of divorce for any cause. Some of the Jewish rabbis taught that unchastity was the only reason for separation (such as Shammai) while others (like Hillel) taught that almost anything could be considered as an "indecent thing" (or an "uncleanness," Deuteronomy 24:1ff.), thus a reason to divorce. Had these men been more observant, they would have been aware that God had always hated divorce, Malachi 2:15-16. The Hebrew prophets had used the idea of marriage to represent the relationship of Israel to God. The unfaithfulness in this marriage relationship even as in the physical realm was a sorry mark on Israel's character throughout their whole history.

To summarize: God always intended marriage at the proper time in life, and likewise intended that such marriage be for life. He (as part of the Godhead) had not changed His plans. Hence, when divorce is considered,

THIRD YEAR MINISTRY

no way out of problems that people get into by divorce was (or is) given (except that of forgiveness) because God never intended for the problem to exist. Hence, questions are asked countless times about such, and those asked (whether preachers, teachers or whoever) have no Bible answer to give, because the Bible does not give any. Sin always creates problems. Hence, we are commanded to abstain from it, over and over again, so that we will not have such problems.

Matthew's phrase, "except for adultery," 5:32 and 19:9 provides the only reason for divorce given. We submit that Jesus did not say that divorce is to occur if such happens, only that divorce may occur (is permitted). The better part is for both parties (husband and wife) to act like Luke 17:1-10 expects them to act, forgive and/or repent, and remain married.

But the reader can easily see that such as we just stated is a matter of opinion over which differences occur. We readily agree, granting that no interpretation is of any authority except as we agree that it is the one intended by the original author. Since Jesus is not here to ask, we have to permit others to do as we want them to do for us (Matthew 7:12 again) and adhere to the best interpretation possible. Whatever we consider the right view of a passage is that to which we are bound. We are not bound to that one view forever, if someone's view, considered at a later date, is thought more correct than the one we hold. We may change our view to suit. We are thus obligated to study God's word to discern the original intent of the author, admit any difficulties or problems that make a firm decision impossible, and obey that which we believe (sometimes we use the words "feel" or "think" as synonyms for believe) is the correct interpretation. We have taken the space to write this, because good honest men have differed over this whole

subject of marriage and divorce for centuries. There is no way to get an authoritative interpretation at this junction of history (the idea of studying a text and asking God for an interpretation is productive of only one thing: making God the author of confusion).

We then can only pose questions for the remainder of the text. For the sake of clarity, we will number the characters involved as follows: husband No. 1, and wife No. 2, a man not her husband as No. 3, a woman not the wife as No. 4.

In 19:9, if No. 1 marries No. 4, is No. 1 the one who sins? Some ancient texts insert the clause that is found in Luke 16:18b. Whether it is to be in Matthew's text or not is questionable, but answer this: if No. 3 marries No. 2, is No. 3 alone guilty of sin? No. 2 is not said to be.

In respect to Marks' account, in v. 11, if No. 1 remarries, against whom does he sin, No. 2 or No. 4? (Who is the "her?"). Is the "wife" the original, or does "wife" mean anyone to whom a man is married? To restate, what is meant by the word "wife" by Jesus—is it only the original woman (the same question is pertinent to the word "husband")? If the answer be yes, then all others are not considered as "wife" or "husband." Back to verse 11, it does not say that No. 1 sins in the remarriage. Does the text in 9:9 apply to No. 1? What does "against her" mean?

To complicate the problem, no one is absolutely sure just what constitutes a marriage, or what breaks it either. Does sexual union do so? Only sexual union? If so, then, 1) the couples (some exist) who never have sexual union, though seemingly married in the culture of which they are a part, are not really married in God's sight; and 2) any sexual union with another makes a new marriage and breaks (?) the old one, if either or both of the

people are married (or is it just the first sexual union that constitutes a marriage?). How do we tell when God considers a man and woman married? If there is unchastity on the part of one, does this permit (or require?) divorce, but not permit (or require?) remarriage? Or in this regard does the "innocent" party have the right to remarriage but not the guilty party? What about the third person involved here—is this one married to the "unfaithful" partner by dint of the sex union or not? If so, why? Does the fact that either party becomes a Christian change the use of terms any? Does marriage become "unmarriage" because the state before God is changed? (Remember, any and all sin is forgiven when one becomes a Christian.) If you hold the position that sexual union, and that alone constitutes marriage, what verse proves that? Or what verse says only the first sexual union?

Turning to Matthew's account in 5:31-32, if No. 1 divorces No. 2, how does No. 1 make No. 2 an adulterous person? By putting her in the position of 1) having to remarry with any remarriage causing her to be adulterous or 2) just making No. 2 appear as if she were guilty of being unfaithful? Suppose No. 1 divorces No. 2 and marries No. 4, why can not No. 2 consider herself free to remarry? Is it because of Luke 16:18b? Does Mark 10:12 not permit No. 2 the same possibility of divorce and remarriage as is No. 1's? If not, why? Does Jesus say in Matthew 5:32 that both No. 1, No. 2 and No. 3 sin in any remarriage, assuming no reason for divorce, but not No. 4?

For a moment, reread Matthew 5:27-30. Since Jesus says that the lustful look is equal to adultery, and No. 2 knows No. 1 has lusted after No. 4, what prohibits No. 2 from divorcing No. 1? (or assume No. 2 lusts after No. 3, etc.) When is adultery adultery?

Does the text in I Corinthians 7:10-11 actually forbid divorce but not separations? Does v. 15 still not permit a woman to remarry even if No. 1 (or No. 2) leaves? Is the marriage still "on" though the couple do not live together? What does the expression "is not bound" mean? is not bound to live together? to remarry? to go through divorce proceedings? or because one is a believer, the other not, no marriage existed? (or does "husband" and "wife" imply marriage?)

By the way, have you discovered the phrase "living in adultery" yet? If not, how do men assert this idea anyway? The texts of the New Testament never use such a phrase at all. Does the fact that a No. 1 divorces No. 2 and marries No. 4, without a just reason, mean that every time the new partners engage in sexual union the sin of adultery occurs? If so, for whom? No. 1 only? No. 1 and No. 4?

Where does the Bible say that if a couple become Christian, and either partner or both have been divorced prior to this union, that the union should be dissolved and each partner is to return to the original mates (if such exist)? Suppose both (or either) have since remarried—why should they (if not Christian) break up a union to accommodate the repentant partner? What we are asking is this: does repentance demand cessation of sin in every way? Suppose that the new Christian is now sanctified in God's sight, and repentance only demands that the future be lived in obedience of God's will—how does the believer stand?

You see, there are no Bible answers to these questions, or dozens of others like them. God simply did not intend for divorce to occur, nor make provision for solving problems it causes. Marriage is for life. Jesus does not even say that marriage is for love, or that love is the basis for marriage and cessation of love the reason for

divorce. We will to love whatever we wish to love. We remain married because we will to do so, whether we love or not. If we cease loving, it is not because we can not love, or do not love, but rather because we will not to love. We can just get to willing to love our partner again. Since that is God's command, we obey.

Incidentally, Jesus makes Moses a real historical figure, and asserts his authorship of at least the portion of Deuteronomy 24 to which reference is made. We point this out because there are many who teach that Moses could not have written the Pentateuch. Jesus asserted the contrary several times, as here and John 5:45-47.

(5) Our text, Matthew 19:13-15; Mark 10:13-16; Luke 18:15-17, highlights an event somewhat like that of Matthew 18. The advantage of parallel accounts is seen when Matthew's account is compared to Mark and Luke. The latter two explain what Matthew's account means by "to such belongs the kingdom of heaven." Mark and Luke show that is the childlike spirit that permits one to become a part of the kingdom. Perhaps willingness to be taught is a major item in that childlikeness. This text is perhaps most familiar for the oft quoted verse from the King James version, "Suffer the little children . . ." Most people do not know that "suffer" has an older meaning of "permit" or "allow" and has nothing to do with our idea of suffer. The verse certainly has been misused because people did not know this fact. For instance, the author has seen pictures and posters of little children who were starving, etc., with large letters across the top, "suffer little children."

A most familiar personage comes into view as we consider Matthew. 19:16-22; Mark 10:17-22 and Luke 18:18-23, that of the rich young ruler. The value of parallel accounts again is seen, since no one account specifically calls the young man that. Matthew notes in

v. 20 that the one coming was young, and a man. Mark notes that he was a man, while Luke states he was a ruler. All three describe him as rich, but only Mark records that Jesus loved him. The answer of Jesus indicates that life eternal was not something to be had for the asking, but was rather a test of obedience and a life-long pursuit. Note that Jesus actually gave five commands to him (while not telling him he did not have to follow the Mosaic law, which was still in force for the young man) 1) go, 2) sell, 3) give, 4) come, 5) follow. If the young man did as Jesus commanded him, he would actually be with the One Who was life, John 11:25-26; 14:6, and Who could really tell him how to keep the law of God applicable to him. Thus eternal life was not a matter of one choice in life, but rather a result of right choices all of life. (Even being loved by Jesus, 10:21, or by God, John 3:16, does not put one in the "saved" group. God does not love anyone enough to save them in their sin.)

The remark of the young man to Jesus, "good teacher" makes us ask what he meant. Did he mean others were selfish, prejudiced, or ignorant? Compare Matthew 22:16 here.

Why did Jesus respond as recorded in Luke, v. 19? Was He trying to find out what the young man meant by "good?" Was He trying to teach the young man something about Himself—such as "Do you address me as God? If so, will you do what I say?"

Matthew, v. 16 records that he ask about a good deed. Did he think that eternal life could be gained by one good deed? Or was it that he was honestly anxious as to whether he had really done what God required? or that there were things (and teachers) that did not lead to eternal life?

THIRD YEAR MINISTRY

When Jesus told him to keep the commands, we note these things: 1) life is a gift of God, but obedience to His will is only and ever the means to attain that life. 2) nor does obedience exclude faith, for faith that God will do what He promised is the motivation to do what He commanded.

Have you noticed that Jesus quoted the last six commandments, those having to do with one's relationship to one's fellow humans? Is the way one does these six a measure of how he keeps the first three?

Matthew records in verse 16 and verse 20 the two questions any and all should ask: "what must I do" (God does not need to do anything for us as He has already done all He needs to do) and "what lack I yet" (God will supply all we need to live for Him, and stands ready to do so).

Was the young man unwilling to love his neighbor as himself? Did riches have him (as was the case of the rich man in Luke 12, and Luke 16)? We might recall the question of Luke 13:23 about being saved, and Jesus' answer: "Agonize to enter!" For few are willing to hate their own life and give up all they possess, Luke 14:26-33. Have you found the "pearl of greatest price, eternal life so fair?" Are you willing to sell all you have and purchase the pearl you have found, Matthew 13:45-46?

(6) The apostle's reward spoken about in Matthew 19:23-30; Mark 10:23-31 and Luke 18:24-30 is the result of the interview with the rich ruler. Perhaps the last condition of the young man as he walked away brought to the attention of the apostles of the difficulty of being saved. Added to this possibility was the actual statement of Jesus in v. 23-24. We do not know for sure, but the disciples may have been thinking something like "If this man, rich, moral, (and whatever else they considered

about him that was advantageous) can not get into the kingdom, who then could?"

But no one starts with the balances loaded in their favor—no one automatically "has it made." But God is the God of things men can not do, and He can make anyone "stand" who so desires, Romans 14:4. Thus in answer to the astonished question of the disciples, Jesus points this fact out to them. When Peter remarks about how much they had left (no more than required, Luke 14:26ff., for anyone who could follow Christ, be he the departing young man or the apostles), Jesus outlines the reward to anticipate in such cases. The fact of reward, though, does not make the decision to serve God any less commendable. The obedient life is what God wants, and desires. We are so formed (God knows our "frame," Psalm 103:14) that all kinds of motivation are both helpful and yet unselfish. It surely is not wrong to thwart the efforts of the devil as he attempts to undo the death of Jesus on Calvary.

In conclusion, Jesus promised eternal life, to any and all who so chose to receive it, in return for placing Him and His message first throughout their life. The departing young man had come seeking just that very thing—how sad to make the exchange he was making! Jesus remarked (about some others) that with such an attitude as the young man's even that which he had would be taken away, Matthew 25:29; Luke 19:26. May we, rather than do as the young man, choose Jesus; and rest assured that "It will be worth it all, when we see Jesus."

(7) "However, it's not going to be like you think it is!" Thus do we paraphrase what we assume is the meaning of Matthew 19:30 and Mark 10:31. Jesus had spoken this little puzzler at the end of another similar lesson recorded in Luke 13:22-30. Now, upon repeating

it, He relates the parable in Matthew 20:1-16 to explain its meaning.

The market place in that day would have been bustling with activity early in the morning, for men would be coming with their tools to be hired for the day. Those in search of help would also be there. Jesus spoke about a certain man who hired men for the day, and the pay agreed upon was a denarius (regardless of what the value of such coin is in regard to our money today, it was apparently equal to a day's wage, and thus comparable to our day's wage). Phillip had reckoned that two hundred denarii would not buy enough bread to feed the multitude, John 6:7; and the ointment Mary used to anoint Jesus was worth 300 denarii, John 12:5. We give a list of different monies used in Jesus' day at Luke 21:1-4.

The owner returned about 9:00 a.m. and finding others unhired, sent them to work also, agreeing to pay them whatever was right. So also at 12, 3, and 5 p.m.

At evening time, the men came to be paid for the day's labor so that they might purchase what was needed for their families (note Deuteronomy 24:14-15). All, beginning at the last hired through those hired early in the day, received a denarius.

Though the first ones hired found fault with the man, he pointed out to them that he was not only doing exactly what he had said, what he had was his to do with as he so choose.

This is the point of the parable and illustrates the verse in 19:30. God, like the owner, keeps His promises, but He remains master. He will do what is right to do, our ideas notwithstanding. As Abraham said in Genesis "The judge of all the earth can but do right." And so God will do right, even as the owner said he would do. No one will merit heaven, and anyone who gets there will do so because God has done right, acting upon His

unchangeable principles. Any and all who accept Jesus as His Son and their savior, and remain in Him until death, will so be rewarded. Who begrudges God's grace to others?

(8) While traveling towards Jerusalem on this last swing around Palestine, Jesus once again predicts His upcoming crucifixion, Matthew 20:17-19; Mark 10:32-24; Luke 18:31-14. He predicts nine distinct things that were to happen, with prophecy being fulfilled as it took place:

1. delivered to chief priests and scribes,
 2. they condemn Him to death,
 3. delivered to the Gentiles,
 4. to be mocked,
 5. spit upon,
 6. treated shamefully,
 7. scourged,
 8. crucified,
 9. and raised from dead after (on) the third day.
- Note that John remarks in 20:9 that the disciples did not know (=comprehend) about the resurrection from the dead.

We do not know why those with Jesus were amazed or afraid, unless they shared the disciple's attitude expressed in John 11:26, or were reacting to something He said, perhaps even this prophecy. Nor do we quite fathom why they did not comprehend what He did say, as Luke reports in v. 34. Did they share Peter's view as expressed in Matt. 16:22, or have such a nationalistic spirit that such things were unacceptable to them? In respect to this last idea, consider the next event with James and John.

(9) Matt. 20:20-23 and Mark 10:35-40 record the request of James and John through their mother (see John 19:25-27 for a discussion of who this may have been) to

THIRD YEAR MINISTRY

Jesus for right and left hand seats in His kingdom. Perhaps the promise of seats in the remarks of Matt. 19:28 might have prompted this request, as Jesus had not previously mentioned such a concept (at least that is recorded). It might have been prompted also by the idea of the kingdom which had been mentioned often. Certainly such a request was not unusual or too surprising in this regard, nor were these brothers the only ones thinking of such things (consider what Jesus' implied in the immediately following verses as well as such texts as Matt. 18:1ff.; Luke 22:24-30).

The brothers and their mother apparently expected the kingdom to be soon. Perhaps they were as ready as they seemed, considering their response to Jesus' question, but the things for which they ask were not to be had by asking. Certainly the expressed promise of that which the men were to endure, whether they understood or not, is important, as it calls to mind Luke 12:49-50, and the evident reference to the events soon to immerse Jesus in the sacrifice for the world's sins.

Not willing to drop the matter, perhaps because of the reaction of the other ten disciples, Jesus details the way to greatness (was that what James and John thought the result would be of having the right and left hand seats?). He calls to their minds the false greatness of rulers of their knowledge. Using His own life as a kind of road map to follow, He teaches that the only great position in the kingdom is that of a servant, and the only acceptable quality is usefulness. Someone has well remarked that greatness has little to do with wishes and wants, but much to do with will and way. Positions are not to be had for the asking, or by demand, but rather are achieved and thus deserved. Greatness is in service—how well does Christ serve through you?

*Jericho—Matt. 20:29-34; Mark 10:46-52;
Luke 18:35-43*

“Lord, my sight. (Please!!)” The problem of blindness was common twenty centuries ago, and even yet today in some cultures. The care of new-born babies was sometimes minus the concern (and/or the means) to protect little eyes. Consequently, many went through life sightless. Perhaps none who can see understand even a little of what it means to live in a sightless world. No sunsets or rainbows, or dew-drops on morning grass, sparkling in the early sun. No azure skies dotted with puffs of white clouds—or whatever you think is beautiful, or even worth seeing—can ever be theirs. Have you ever tried to describe the unseen to the unseeing?

The temple built by Herod might not have been the measure of Solomon’s a millennium earlier, but every Jew could still find much about it to gaze upon, and in which he might daily glory. The beautiful courts and porches, the Levites in their daily ritual, the priests as they served the altar or Holy Place—all were nonexistent for the men of our text, or any who were blind. Begging was the common way of life for such as Bartimaeus, son of Timaeus. For the Jew—the climax of a despairing life.

It is no marvel that the name of Jesus should produce such endeavor in a man that he would ignore the problem of going from one end of Jericho to the other to catch Jesus as He came out of the town (He stayed with Zacchaeus while in Jericho, thus giving Bartimaeus and his blind friend time to accomplish such), or pay no attention to those in the crowd who wanted to silence his attempts to get the attention of Jesus.

Faith was the contact point and Jesus was the power; hence, Bartimaeus received what few ever did or do—his physical sight (back again?). No longer dependent

on others, he rejoicingly followed Jesus on the way up to Jerusalem, there to share in the city itself, but more, the temple services were to be a part of his life as never before.

Such is ever the way when Jesus is contacted—the whole world is seen as never seen before—and those who contact Him go on the way, rejoicing!

A remark or two about the text. It has often been pointed out that this text has contradictions in it. Matthew's account has two blind men, and Mark and Luke only one. Matthew and Mark locate the incident at the exit of Jesus from Jericho, while Luke writes about the healing of a blind man as Jesus went in.

There is no particular necessity to affirm a contradiction if the events of the text in question can be accounted for, while not having to prove that the event must have happened a certain way. It is common knowledge that an account of an event may be true and yet the reader not understand just how it actually happened. Then, though we might not be able to solve the apparent discrepancy, others might already have done so, or could do so. Perhaps additional consideration of the problem will allow its resolution, as is often the case. Remember: No contradiction exists unless one text affirms that which the other text denies.

Hence, in the problem of the two men versus the one man, if there were two, quite obviously one was present. Mark and Luke simply chose to mention one of the two. There is a problem of locations which can be resolved by supposing that 1) either Jesus healed one man going into Jericho and two going out of it, thus actually healing three men (there were ten lepers at one place together, if three blind men seem to be too many), or 2) there were at least two locations called Jericho (and there is some evidence for even three different sites) which there were, an old Jericho and a more recently built Jericho

NEW TESTAMENT HISTORY: THE CHRIST

about one mile south, or 3) Luke simply reports about a healing, which started on one side of Jericho with the blind men learning about Jesus going by, and then being healed by Jesus as He went out from Jericho (the blind man having gone around and waited until Jesus came out). Any of these three possibilities, or others not mentioned, could account for the apparent problems in the text. We ought to at least assume the original text was correct, and if we have a reasonably accurate copy of such, that the Bible deserves as much effort to understand it as we give less important events of our daily lives.

Jericho, one of the oldest known Biblical cities, dating back to perhaps c. (=about) 6-8,000 B.C. Built and destroyed several times, it held a prominent place in the Old Testament history and down to the New Testament times. Some seventeen miles from Jerusalem, one traveled from about 1,000 below sea level up to Jerusalem (which was about 2,550 above sea level) along a rather difficult terrain which provided many such opportunities as recounted in Luke 10:30ff.

Historically important to our Bible in many events, such as with Joshua in Joshua 2, 6 and 7; David, II Samuel 10; Hiel the Bethelite, I Kings 16:34; Elijah and Elisha, II Kings 2; Zedekiah, II Kings 25 and the rebuilding of the walls of Jerusalem under Nehemiah, Neh. 3:2; the New Testament Jericho was Herod the Great's winter capital. Building beautiful buildings of Hellenistic (Greek) style, including pools, a palace, a theatre, a fortress and hippodrome, the city was also made inviting by a plentiful water supply from nearby springs, and a tropical climate that allowed groves of palm and balsam trees, (which only grew in the Jordan Valley and on the coast) that provided revenue. With streets lined by sycamore trees and gardens of roses and such things as

THIRD YEAR MINISTRY

mentioned above, it is no wonder that many of the priests and Levites as well as others made Jericho their home.

Zacchaeus—a name detested by many. The reason? He was a Jew who had hired out to the hated Romans for the despicable job of tax collecting. The common word in most Bibles for such is publican. Certainly, as with Matthew, the tax collector was low man on the Jew's totem pole, or top man on his black list, whichever way was worse.

Zacchaeus was a tax collector. The need for such in that day is made clear by archaeological finds which indicate that a heavy rate of tax was imposed on both imports and exports, and in addition, the individual merchants had to pay heavy taxes. Some evidence for a twenty per cent tax has been found.

Smallness of stature may sometimes be helpful, and Jesus was just the help Zacchaeus needed, though the text does not indicate he was necessarily doing anything more than trying to catch a glimpse of Christ.

The crowd was quite right—Jesus had gone to eat with a sinner. However, the lost became found, and doubtless those who in some way henceforth came in contact with Zacchaeus were glad it happened. Certainly his efforts at honesty, charity and restoration of wronged people bespeak the essence of godliness.

Road to Jerusalem

The road to Jerusalem would be crowded with people going "up" (notice the writers of the New Testament and their accurate descriptions of the relationships between locations of various cities, etc.) to the city of peace (Jerusalem), with some going early to enter into rites of purification (as in Jn. 11:55) from things such as Jesus mentioned in Luke 11:44 (see the discussion under # 63).

Perhaps the general attitude such a miracle would elicit in the hearts of the beholders was the impetus for spoken exclamations about the coming kingdom. At any rate, Jesus attempted to squelch any "kingdom fever" by the parable of the pounds.

Luke 19:11-27 contains a parable less well-known than the similar one of Matt. 25:14-30, but certainly not less important. Jesus draws a vivid picture of His kingdom, complete with the idea of the ruler leaving to receive kingly power and then returning to ascertain the conduct of the servants left in positions of trust.

He attempted to set the scene in the proper historical perspective, so that the root of much false thinking among the disciples (that the kingdom was near as they thought about kingdoms) could be eliminated. The effect of this would be that they would quit living in dreamland and get down to reality. It was not that the fact of the kingdom's presence was not a reality (Jesus and John had both preached about its nearness to motivate people to repent), but the nature of the kingdom and the events soon to happen in Jerusalem to its king needed to be understood. The rule of Jesus was announced at Pentecost when Peter told his hearers that Jesus was made both Lord and Messiah. Throughout the New Testament, He received the title Lord, but certainly in a new sense after Pentecost (or even after the resurrection, as Thomas might tell us, John 20:28) which we have no need to elaborate upon.

The parable outlines various responsibilities for every servant in the kingdom, and a corresponding judgment and reward. If the servant loafed, it was inexcusable. The conclusion of the parable finds the listeners so intent on the words of Jesus that they interrupt Him. The reckoning of the master with His servants tells us that we cannot be fruitless, but must be active and that be-

FINAL WEEK

cause we realize the nature of our stewardship to the Master. It may be that the reference in v. 14 is to the Jewish nation which in general expressed just such an attitude. Read the parable of the wicked tenants in Matt. 21:33-43 in this light.

LAST WEEK IN JERUSALEM AREA

*Bethany—Matt. 26:6-13; Mark 14:3-9;
John 12:1-8*

The arrival of Jesus at Bethany begins the last week of events prior to the crucifixion. As the reader may see, the account of John is being followed as to chronological order. The accounts of Matthew and Mark are not in such order, but rather were used by those authors to illuminate the background behind the treachery of Judas.

Several facets of this event are interesting. We do not know the relationship of Simon the leper to Jesus or to Mary, Martha and Lazarus. He apparently (?) had been healed of leprosy, but the text does not state that he was present, just that it was his house. It may be that Mary, Martha and Lazarus had either bought, rented or borrowed the house for the event.

Another item that is interesting, but just as impossible to settle, is the day upon which this occurred. Six days is the time mentioned by John, but what six days? Six days inclusive of the day of anointing, or excluding it? The text does not say that the day of the feast was on the day of arrival, just that He arrived six days before Passover. John locates the feast, as mentioned, prior to the Passover, Matthew and Mark using the indefinite words "while" or "when" in their texts. But John does not specifically state upon what day. For that matter, we are not sure if the word Passover means the feast (as it often

MAP NO. 7—LAST WEEK

1. Bethany—Feast, Mary anoints Jesus, Mt. 26:6-13; Mk. 13:3-9; Jn. 12
2. Jerusalem—Triumphal entry (Sunday) Mt. 21; Mk. 11; Lk. 19; Jn. 12
3. Temple, enters, looks around, says nothing, leaves, Mk. 11:11
4. Curses fig tree (Monday), Mt. 21; Mk. 11
5. Temple—cleanses 2nd time (Monday), Mt. 21; Mk. 11; Lk. 19
6. Temple courts?—Great day of discussions (Tuesday)—Mt. 21-22-23-24-25; Mk. 11-12-13-14; Lk. 20-21-22
7. Retirement to Rest?—(Wednesday), Judas plots to betray Jesus, Mt. 26; Mk. 14; Lk. 22
8. Upper Room—(Thursday), 4th Passover, Lord's Supper, Mt. 26; Mk. 14; Lk. 22; Jn. 13-14
9. Gethsemane—(Thursday night), Parting discourses, agony, betrayal and arrest, Jn. 15-16-17; Mt. 26; Mk. 14; Lk. 22
10. Trial before Annas and Caiaphas, Mt. 26-27; Mk. 14-15; Lk. 22-23
11. Trial before Sanhedrin, Jn. 18
12. Trial before Pilate
13. Trial before Herod
14. Trial before Pilate (2nd)
15. Golgotha—(Friday), Crucifixion, Mt. 27; Mk. 15; Lk. 23; Jn. 19
16. Garden—(Sunday), Resurrection, appears to Mary, other women, Mt. 28; Mk. 16; Lk. 24; Jn. 20

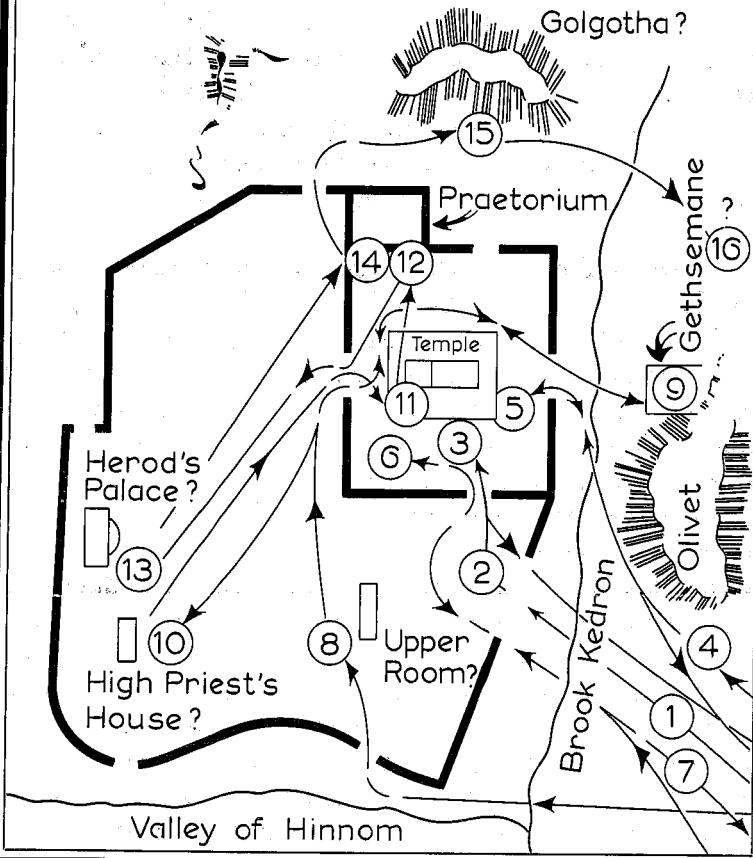

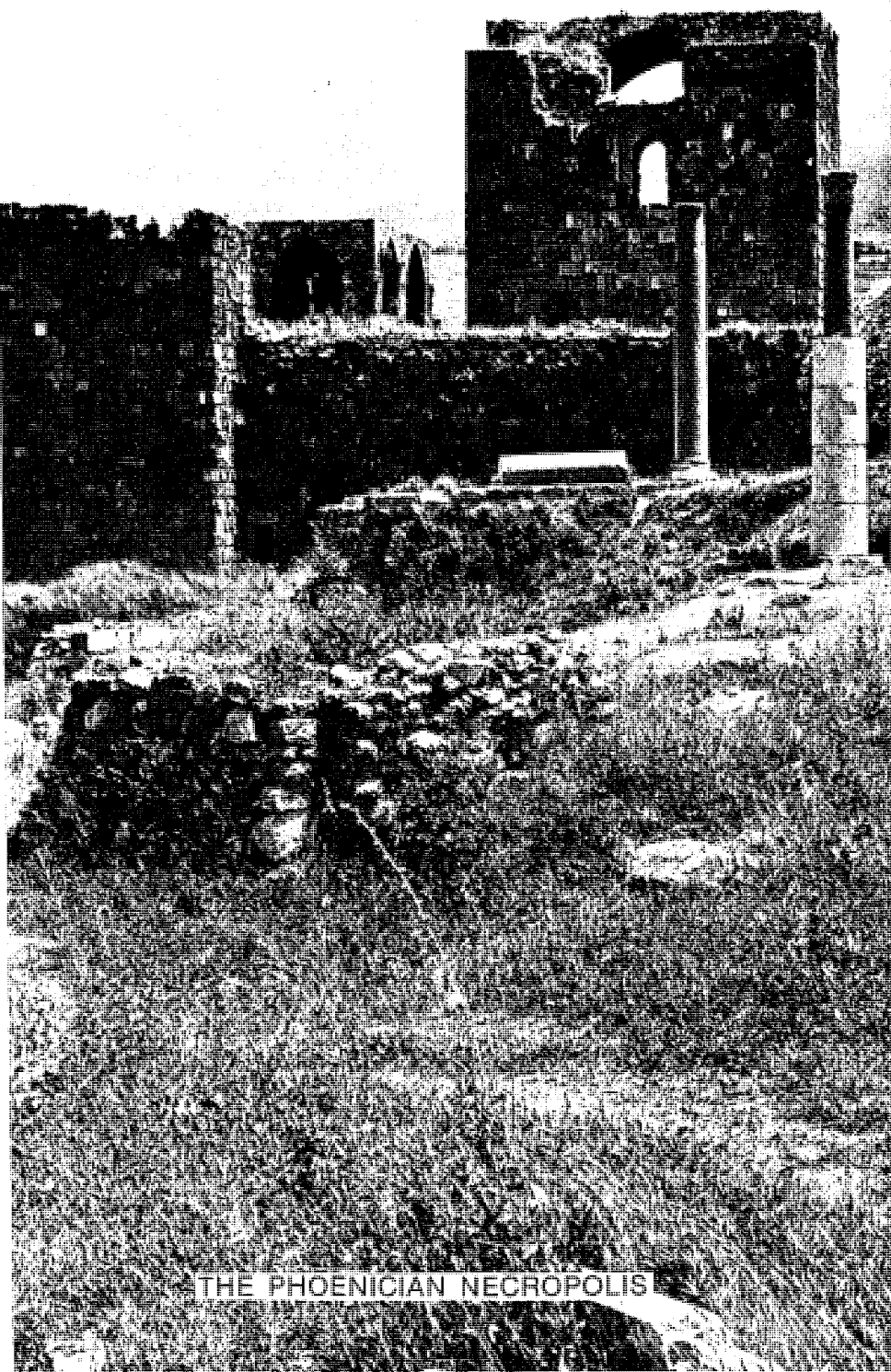

THE PHOENICIAN NECROPOLIS

does) or the day of Passover (which began on a Thursday at 6:00 p.m.) or the day the lamb was killed (which would have been the Thursday mentioned, but prior to 6:00 p.m.) often known as the first day of unleavened bread (the whole feast was sometimes referred to in this way), though it was actually only the day the leaven was taken out of the house in preparation for a week (seven days) of unleavened bread. Hence, we do not know when this feast occurred, and cannot use it to determine any event following, though John specifically states the feast occurred the day prior to the triumphal entry. However, the reader must remember that one day ended and another began at 6:00 p.m. in the evening as we count time, not at 12 midnight as for us. Thus, we really do not know on what day for sure the triumphal entry occurred. It might have occurred at the end of the Sabbath Day and finished up on Sunday, since the shift in days occurred at six in the evening. For that matter, there was no specific law that kept the people home on the Sabbath Day, and depending on where Simon's house was (if Jesus was staying there,) the triumphal entry may have taken place on the Sabbath. There were no laws prohibiting such. Even the traditional Sabbath Day's journey is not actually defined in the Bible. Acts 1:12 gives us the common thinking, but the law does not spell it out. The text in Ex. 16:29 finds Moses commanding the people not to leave their own place, but that is as close as we can get. The text in Josh. 3:4 about 2000 cubits was supposedly used by the rabbis as the distance one was permitted to travel. However, again, we do not know if this was so or not. Whether Jesus observed any such tradition is doubtful. We know He went to the synagogue each Sabbath Day, Lk. 4:16, but what this entailed in the way of travel is unknown. Did the trip through the grain fields on the Sabbath (Matt. 12) involve only a distance of 2000 cubits?

The Bible student needs to know what the Bible says as well as what it does not say.

We are reasonably sure what kind of ointment Mary had, called nard. Probably the ointment, rose-red in color, made from the dried roots and woolly stems of the spikenard plant is meant. It was made in northern India, hence very expensive. John uses a unit of measure (translated a pound) equalling about twelve ounces of our English weight. It was, and yet is, transported in an alabaster box or container. Alabaster is a fine-grained gypsum, somewhat like onyx, and mostly mined in Egypt. But the estimate of Judas as to its worth is just that, though perhaps true. If his estimate were correct, then the amount equaled almost a whole year's wages, using Matt. 20:1ff. as a basis.

We have already mentioned the problem about whose house it was—the reason the question is raised is because Martha served, which would be a bit uncommon unless it were her house, or being used by her.

Comparison of the three accounts shows several things. One is that the woman unnamed by Matthew and Mary was Mary, sister of Lazarus and Martha (and not the woman of Luke 7). Matthew and Mark do not name just who of the disciples was indignant about the action of Mary, but John shows that Judas was the instigator, and also the reason, for Judas was a thief, as well as group treasurer, and wanted that money. The intense feeling of Judas may well have provoked his bargain with the priests within the next week. We also can piece together the fact that Mary placed some of the ointment on both the head and feet of Jesus.

The remarks of Jesus were instructive. The poor would always be present, the efforts of society notwithstanding. The gift of money to such causes was (and is) not always the right use of it, neglecting the Lord in

other ways. He did not forbid gifts to the poor, but simply commended the timeliness of the gift. However, the remark about the reason for the anointing is not so clear. It may be that Mary was more perceptive than some, but Jesus does not say that she purposely anointed (by the way, this is the only time we have record of any anointing of Him, though the word "Christ" comes from a Hebrew word meaning "anointed" from the custom of designating new kings, etc.) Him because she understood He was about to die, but rather that in so doing she prepared Him to do so. John's expression in v. 7 is enigmatic, too. Does Jesus mean "keep it" in reference to the remaining ointment or keep the memory she has in mind?

Judas thought the act was a "dead loss" but Jesus remarked that the world would ever remember the act. The reaction of Judas is ever that of the world. Any sacrifice in His behalf is always a waste to some people. But love must express itself, and Jesus called such expression "beautiful". May we ignore the world to gain the praise of Christ, our anointed One.

*Jerusalem—Matt. 21:1-11; Mark 11:1-10;
Luke 19:28-40; John 12:9-19*

The triumphal entry, as man has been pleased to call this event, probably took place on Sunday as the outline mentions, though the exact time is unknown and not vitally important. This is the first time that all four gospels have related the same event since the feeding of the 5,000 at the end of the second year.

Many things are of interest in this event, and one of those is the crowds of common people (one which had come over to Bethany earlier and one which came out to meet Jesus and the other crowd) and their reaction to

FINAL WEEK

Him as compared to the rulers. Luke records (the reader should make special study of this account to see how many incidental things he adds to the picture) that some Pharisees told Jesus to shut His disciples up when they hear the shouts of the people which acclaimed Jesus as the Son of David, and thus the Messiah and king of the kingdom as God had promised David. Verse 40 reveals that Jesus informed them that even the stones would bear witness if these people did not do so. We add that when the crowds became silent, the stones of the empty tomb did bear witness to Jesus' deity. When some of the other rulers saw the impact Jesus was having upon the multitudes, they exclaimed to each other that the world had gone after Him, and that they could do nothing, v. 19. Whether they meant that all efforts to change Jesus' influence on the crowds was vain, or that the time had come to cease talk and get on with the business of killing Him is debatable.

The procession started somewhere around Bethany (and a neighboring community of Bethphage) on the eastern slope of Mount Olivet, when Jesus directed two of His disciples to go get a colt and its mother. When the owners asked about their property being removed by the disciples, they answered, as given by Jesus, "The Lord needs them." The disciples did not know which of the two Jesus would ride, so they placed garments on both, though the accounts specify Jesus sat upon the colt, fulfilling the prophecy of Zechariah 9:9.

The shouts of "Hosanna" (which probably means something like "(God) save (us)" or "(God), make us safe") and other ideas of the crowd with Him soon attracted another crowd from the throngs in Jerusalem for the Passover Feast. When the large group with all the noise came into the streets of the city, some were told, when they raised a question of identity, that the person

being so honored was Jesus, the prophet from Galilee. For any conscientious Jew, this would be great news—a prophet no less, and hard on the heels of that other prophet, John. Certainly the Jewish rulers had reason to rejoice when Judas came and told them how to get Jesus quietly, without the knowledge of the crowds. A tumult would have been caused for sure, had the crowds known. We make these remarks now because the reader needs to see why the action of Judas was so important to the rulers, and also why the Jewish leaders had the trials and crucifixion over and done by early morning—the crowds of people who would have been sympathetic for Jesus were not up and around to interfere.

One thing that is of interest, and doubtless confused the disciples who had closely followed Jesus—why did He now accept such tribute in such a public place and under such circumstances, when He had never done so before? The whole event proclaimed for all the Jewish world that Jesus, in accepting the things shouted by the crowds, was their Messiah, the Coming One. He had never allowed such before, and now—in Jerusalem even! The text in John, v. 16, underscores this confusion in the minds of the twelve, at least. Those in intervening centuries who have said that Jesus never claimed to be the Messiah (Christ) just do so out of willful ignorance, more times than not.

Luke 19:41-44 informs us that Jesus wept over the city, and expressed heartfelt sentiments much as He did at other times, we suppose. However, by the action of the event, He took charge of the issue between Himself and the rulers, ignoring their authority, and accepting the claims of the crowd for His Messiahship, which only added fuel to the fire, and forced the hand of the rulers. The action of Judas with the possibility of a secret arrest comes into sharper focus now.

FINAL WEEK

When Jesus spoke of the future catastrophe to happen to Jerusalem because of its ultimate rejection of Him, we remind the reader the armies of Rome did just that (see the same prophecy in Matt. 24:15-28, also Mark and Luke) in A.D. 68-70. The resistance of the Jews was so extended and strong that the Romans leveled the city, leaving only three city gates standing, that the world passing by might take note and heed.

Mark 11:11 indicates that the day was over when Jesus actually got into Jerusalem, and He, with the twelve, returned to Bethany for the night, as v. 19 also indicates.

The next day the Savior with the twelve returned to Jerusalem. The possibility of going over the top of Mount Olivet to Jerusalem and returning to Bethany by going out the south east side of Jerusalem and around Mount Olivet may help the reader understand why the disciples did not see the fig tree Jesus cursed until the following morning.

Perhaps a word about fig trees is in order here. The texts concerning the whole event are Matt. 21:12-22 (note that Matthew does not recount the fact that the cursing took place on one day and the disciples' reaction the next day); Mark 11:12-14, 20-25. Mark's account gives the information in v. 13 that it was not the season for figs. Of course not—the normal fig season was in the summer or fall along with the other later harvest crops. However, at least two types of fig trees grew in Palestine, one which had fruit and leaves at the same time, another having leaves and then fruit. This fact may account for the expectation of Jesus for fruit.

Whether we ever really understand the "why" of the action of Jesus, if it was to teach a lesson to the disciples about the power of prayer, or if it was an object lesson for the disciples about the fruitless life, or perhaps a vivid portrayal of why God was going to Jerusalem to "clean

house" and take away the kingdom from them to give it unto a nation bringing forth the fruits of the kingdom, Matt. 21:43, we may never know. Make no mistake about Jesus, though—it was not just a mere man who walked up to a tree one day but was fooled by its appearance. God in person walked up to a part of His own creation that day—God does not make mistakes. The reason for the cursing may ever be unknown to us, but Jesus had a reason. It may have been to teach the lesson of what is possible through the power of faith.

*Jerusalem—Matt. 21:12-17; Mark 11:15-18;
Luke 19:45-48*

The sin of a nation is reflected in many ways—its national policies, literature, art, music, even religion. Men tend to become like the society in which they live. People in power tend to satisfy the clientele. What Jesus might do or say about the religious groups in America is anybody's guess, but He put action to His words about the center of Jewish worship, not once but twice, and within three years of each other. John 2 recorded the cleansing by Jesus of the temple at the beginning of His ministry. Now at the close of His ministry, He does the same thing again. Quoting Isa. 56:7 and Psalms 8:2, He proceeded to drive out those selling animals in the temple grounds, overturning the tables of the moneychangers, and force those who sold pigeons to leave. It was not that these things were not needed or unlawful, it was where they were being done that made the difference to Jesus. Perhaps the reader ought to meditate on His description of the status of the temple grounds: a *den of robbers*. Even then, the chief priests were agitating for His death! When He healed those needing help, and those same chief priests (and scribes) saw what marvelous things He was

FINAL WEEK

doing, rather than praise God for the goodness of His heart, they increased their zeal to destroy Him, and that in spite of the fact that none of the multitude sided with their desire to kill Him.

Is it not ironical that these men were finding fault with people being healed and children praising God, but would plot the murder of both Jesus and Lazarus, and allow such things to go on as Jesus attempted to stop? What blind spots we often have, especially when it comes to our own sin.

Jerusalem—The Day of Discussions

The outline hints that the day may be Tuesday. It is one in a succession of three days as Mark records the events. But the mention of two days before Passover in 14:1 does not tell us if the days are exclusive or inclusive of the day of discussion. If exclusive, then the day was Tuesday, with Wednesday and Thursday being the two days, Passover starting on Friday, which would start at 6 p.m. Thursday our time. This would place the cursing of the fig tree and the cleansing of the temple on a Monday and the triumphal entry on Sunday. But nothing is certain, and no doctrine rests on whether we can tell when the day of discussions was (though when Jesus ate the Passover meal is an issue of importance).

(1) Matt. 21:23—22:14; Mark 11:27—12:12; and Luke 20:1-18 record the re-entry of Jesus into the temple the day after the cleansing and the issue of authority was immediately broached. The men had a right to ask as they had jurisdiction over the temple. Jesus replied to the question by bringing up the issue of John, and by relating three parables, the parable of the two sons, the wicked tenants, and that of the king's wedding feast.

The first part of a four part answer was the issue

over John's authority. Doubtless it was a touchy issue, since they apparently were among those who have refused his baptism, thus rejecting the fact that God had sent him (Luke 7:29-30). They carefully "reckoned up" the issues, and replied that they did not know the answer to Jesus' question. But they were the only ones who should have known! Jesus stamped His approval on John's ministry, and condemned them in the process.

The reason Jesus asked the question was to make them declare the standard by which they determined authority. If their standard included such things as His signs and teaching, then they would have been on the same basis as He was. But the reader can readily discern that such was not the case at all. Their own selfish causes formed the basis for anything they decided. We would call them "situation ethicists" today, or a somewhat similar term oftentimes, "politicians."

Since they could not decide for John, who only had a message, obviously they could not decide for Jesus, who had both signs and message. It is interesting, though John had been dead for some time, how much he was admired by the multitude and such fact was so apparent that the temple politicians were unwilling to even say anything for fear of being stoned, Luke, v. 6.

(2) So Jesus posed a story of a father with two sons, the second part of the answer to the question of authority, and slyly trapped them into answering. The son who responded to his father with a firm "I, sir, will go!" was equal to these men. Their outward profession witnessed to the supposed truth that whatever God said they would do. But they said and did not (Matt. 23:3). Such despicable characters were what caused Jesus to say what He did in Luke 19:11-27; 40-42; as well as the next two parables in Matthew and all of Matt. 23:1-39.

FINAL WEEK

(3) The third part of the answer, again turning on the issue of authority, centered around a rather common business deal, that of a land owner who subleased his farm to others. The parable was placed within the daily life of the listeners as Jesus described the man planting a vineyard, enclosing it and building a watchtower for protection, and digging a winepress to be used for the harvest of grapes. One way to build a winepress was to dig a hole in the ground, or in rock, in which the grapes could be placed when ready to extract the juice. This was the top part of the press, and this part would have a small opening in the bottom of it so when the grapes were pressed down, the juice would run out into a lower cavity in the earth, or some sort of receptacle.

The parable itself represented a story of God's dealings with the Jews. He had, as it were, made the nation as tenants, from whom he expected fruit. His servants, the prophets, had been sent but greatly mistreated by the nation. The sending of "His beloved Son" was done in Christ, and as had been predicted in Psalms 118:22-23 a millennium earlier, the Son was rejected. The sentence upon such conduct was expressed in v. 43, thus ending God's dealings with the Jews as a special people. Henceforth and forever, the only people who would (are or will) receive any special favors from God are His own people (Titus 2:14; I Pet. 2:9) bought with the blood of His Son and part of the Son's body, the church. Thus did Peter and the apostles have to learn (Acts 2:39; 10:34-35; 26:16-18; Gal. 3:25-29).

God had always so planned as Ephesians 1:3-12 tells us. (It was not an afterthought as those who adhere to some versions of pre-millennialism hold, or as is taught in such perversions of Bible teaching as can be found in the Scofield Reference Bible. Such doctrines make the Savior less than divine, and the church a stop-gap measure until

the Jews get back on the right track again.) This is clearly seen and pointed out by Paul, the apostle to the Gentiles, in Romans 15:9-13; as he quotes from the Old Testament to prove the point that God had always intended to bring Gentiles into the fold. The apostles took a lot of persuading, as did the rest of the Jewish nation, that they did not have a corner on God nor had they ever. Jesus pointed this out in Nazareth as recorded in Luke 4:16-30. The passage quoted by Jesus in Mark 11:17 from Isaiah 56:7 refers to "all nations." The whole premise of the book of Romans is this: Any and all who would be just can be so through faith.

The tenants obviously did not respect the authority of the land owner, and so acted as they did. When Jesus asked His listeners about the consequences of killing the heir, they replied that the man should take away the vineyard from them and give it to others. Jesus then quotes the passage from Psalms as if to say, "Yes, is this not exactly what was foretold?"

The account in Luke provides an additional sidelight from the crowd. Verse 16 tells us that some of the crowd exclaimed, "May this never happen!" (Should the reader be unaware of the Greek text, there is absolutely no word for God in the text. It is simply an expression conveying the idea of prohibition of something that might be done or said. There is no reason at all for any version, including King James, American Standard or Revised Standard to translate as they do. One wonders what the translators were doing when such was allowed to happen. The same expression occurs some fifteen times in the New Testament, all carrying the same idea as noted above.) Whether they had reference to the action of the tenants or that as expressed by the rest to be a just punishment is impossible to tell.

FINAL WEEK

Once again the gospel writers call to our attention the fact that Jesus would have been killed if the admiration of the people for Him had not deterred the chief priests and company. So these men greatly rejoiced when Judas came with a plan to take Jesus in secret, Mark 14:2, 11; Luke 22:3-6.

(4) The last part of this four part answer on authority is recorded for us only by Matthew, in 22:1-14.

The setting for the parable is that of a king and his subjects. The occasion: The prince and his marriage supper. The invitations were given early, and when the feast was actually ready, the servants sent to inform those already invited to come. It seems that those people would have realized that the invitation might largely, if not altogether, have been given through grace, not merit—which is certainly the case in the kingdom. Too, one would not often have an opportunity to attend the wedding of a king's son. Despite all these and other reasons, people made the issue revolve around their own interests, which were both trivial and transient. Those who were invited later were like the first group in that the invitation was conditional. The wedding garments had been furnished, and all were to wear them. Hence, the man who was found without his garment was not really different in principle than any of the others who refused to come, for he had despised the authority of the king. Thus all who came or did not come were subject to the king. Those who held their relationship to the king in the proper light were treated to a great occasion.

Thus the issue was clearly presented again of authority—and Jesus' relationship both to God and God's people. Those who spurn God by rejecting His Son cannot claim Him as their father, no matter how they may attempt to do so, Luke 10:16; Jn. 5:23 and I Jn. 2:23. And the tragedy of it all was not being thrown into outer dark-

ness with the punishment there, but rather in missing the feast!

(5) Our next incident brings a group of people together who surely were strange bedfellows. Yet, the common enemy named Jesus glossed over their differences. The men only had one purpose and that was to deliver Jesus to the governor, Luke 20:20. The gospel writers point out that Jesus knew these men had sinister motives in their question. Not many things the Herodians (a political party which was pro-Roman) did were otherwise. The Pharisees were not a great deal better.

The question posed to Jesus was fraught with problems, and one designed to alienate Jesus with the crowd. No Jew liked the Romans, or the taxes levied upon him by them. So the men supposed that 1) if Jesus upheld the taxes, the people would become haters of Him, or 2) if He spoke out against Rome, they would have ample reason to arrest Him. The reader will remember that one of the charges leveled against Jesus at the trial was that of forbidding payment of taxes to Caesar, Luke 23:2.

Though such were the issues, the men remind Jesus that they knew He does not respect anyone above another, so He will no doubt tell the truth about the matter without fear or favor. The Greek word used about respect for position carries the idea of lifting one's face up by compliment, and so to regard with favor.

The question about taxation being lawful was asked in connection with rightness, not public policy or necessity. The people had been reminded by Samuel that such would be a problem to them when they asked for a king, I Samuel 8:4-20. Of course, a theocracy would have no problems along this line, but the world got in God's people, and now they were paying for it.

Jesus asked for a coin, and someone gave Him a denarius, which had Caesar's likeness upon it. He then

FINAL WEEK

expressed the principle that service (implied in coinage) gave the right to ask for support, or stated a different way, the laborer is worthy of his hire, Deuteronomy 24:14-15; Matthew 10:10; I Timothy 5:18. So Paul in the ethical section of Romans reminds the Christian of his duty to God, 12:1-2; and related to the duty (since it was the will of God) was the Christian rendering to Caesar, 13:1-10.

Because the people listening readily saw the principle involved when Jesus pointed it out, as did the questioners, the first round is scored as 1-0 in Jesus' favor.

(6) Not to be outdone by the Pharisees, the uniformitarians of the day came to Jesus with a question about the future life. (The word "uniformitarian" conveys the idea that the past is identical to the present so that the present is the key to understanding the past. It also has the idea that man can thus determine all things for himself by proper use of the present. But see II Peter 3:1ff.) Somewhat ironical, and yet madly methodical was their question, since it not only involved a subject upon which the Bible said nothing directly and a very little indirectly (which they thought placed Jesus in a position of arguing about implications of verses or admitting He did not know) but also presented an ethical problem apparently without solution.

So that the reader may appreciate better not only the question but Jesus' answer, we give the following statement of the Sadducees' position: they did not believe in any future state for anyone, arguing against both a resurrection (which implies a future life) and any heavenly beings, Acts 23:8. The issue must be clearly understood: they asserted *no one* lived after death, and thus no future life, obviously.

The rabid evolutionist of our day is little different, if he believes in the evolutionary theory all the way. He

will assert no cause for the world, and no future life in another world, since no god. Very often the commonly accepted principle of cause and effect is rejected, since the world (an effect) argues for a cause at least as great as it is. (Yet, they expect this argument to cause every person who hears it to accept their position. Is that not operating on the principle of cause and effect?) Things in the past can be understood by the present! Man is the measure of all things. Some people try to maintain the dubious position called theistic evolution, which asserts in general that God exists and just used the evolutionary principle to produce the universe. We think the position without any basis in fact, and is but a poor substitute for the position of either going all the way with the theory of evolution or the Biblical position of creation. The article on evolution under selected studies will present the case a bit more in detail.

The answer of Jesus clearly stated one thing, among others: all live to God in the future state, Luke 20:38b. The statement was not equivocal at all, and asserted the position of the Sadducees was dead wrong. Those who argue for the idea of annihilation of the wicked are just as wrong as the Sadducees were, for "*Everyone* (in contrast to *no one*) lives to God." As Jesus pointed out (a bit of a slam against the Sadducees, since He quoted from the Pentateuch, which they held was divinely given, not to mention their adherence to Moses) God was not a God of dead beings but of living beings. He argued from His own statement in Exodus 3:6 about the relationship of God to dead people (remember, now, that He is deity, and is actually quoting what He Himself said, which utterance Moses recorded under His direction). The text in Luke 16:19-31 clearly argues the same point, which is the reason those who hold the position of annihilation of the wicked always attack it so ferociously. The text in

FINAL WEEK

question negates their arguments just as well as the Sadducees in fact, as the principle being discussed is the same: does "death" mean cessation of existence or something else? Jesus said in effect, it only means that the personality involved passes out of one state into another. Compare the discussion under # 62 about the word death, and these passages which use that term; Luke 15:24, 32; 16:19-31; John 5:28 (tomb=dead people); I Corinthians 15:30; Ephesians 2:1; Colossians 2:20. The article about death in the selected studies should also be read.

The question about future existence settled, the future state was presented as being considerably different than the Sadducees assumed. (It is definitely of interest that Jesus spoke so clearly on these questions. As He pointed out to Nicodemus in John 3:13, He knew about His subject because He came from heaven. Check the text in John 17:5 for this idea.) The Old Testament text Deuteronomy 25:56 was thus properly applied only to mortals, not immortals. We can only guess at the great number of hours foolishly spent by people who attempt to ask or solve some problem such as this one. If God had told us everything we could think to ask, we would not want to search through the immense volume that would be needed to answer such questions. If we did, we might not understand how the answer could be true. God has revealed enough to allow us all to accept Christ, become saved and stay that way. He can take care of the rest of such problems as the above until such time as we are adequately prepared to receive what He will give in this area.

(7) Round two finds the score at 2-0 in Jesus' favor. As the Pharisees noticed, Jesus effectively muzzled (meaning of the Greek term) the Sadducees. The Pharisees were game for a third round, and came asking Jesus about the greatest commandment in the law.

NEW TESTAMENT HISTORY: THE CHRIST

Now the Sadducees held to the written law alone being authoritative, but the Pharisees held both law and tradition equally binding. Someone has said that later Judaism had 248 affirmative precepts, one for each member of the body, and 365 negative precepts, one for each day of the year. Whether the Jews of Jesus' day had that many or not is unknown, but the efforts of Jesus to lift the heavy burdens (Matthew 23:4) imposed by the scribes and Pharisees probably indicate that they had a goodly number, and a cursory look at the Jewish Talmud (a collection of interpretations by Jewish scribes of the Old Testament law) which has many, many laws, will show that heavy burdens had been imposed by the rabbis. Most of what was extant in Jesus' day is probably contained in a work known as the Mishna, compiled c. A.D. 150-200 by a Jewish rabbi named Judah the Prince.

To the question: the Greek term used to ask about the command may have to do with the idea of quality, the idea being this: what quality makes a command the greatest? Jesus promptly quoted Deuteronomy 6:4ff. and Leviticus 19:18 as inseparable from it. One cannot separate life into unrelated areas if one is to be godly. A relationship to God is not what it must be to please Him if the person in question ignores the obligations within his societal relationships. Jesus often pointed this fact out, as in Matthew 5:21-26; and Paul did, in Romans 13:8-10.

As the scribe answered Jesus, he too had caught the idea: the inner man is all important—mere externals are abhorrent to God (read Isaiah 1:10-20) if the whole person is not involved. Saul had to learn the bitter lesson, I Samuel 15:22-23. Jesus said that God sought those to worship Him who would do so with the inner man, the spirit, the real "us," and by means of truth (reality),

FINAL WEEK

rather than the hypocritical formalism which characterized the majority of worship in that day.

So we learn that obedience is better than sacrifice, but love directed in the right action is better than all. We will to love the right things. The emotion of love may be inately ours, but the Scripture clearly teaches that, whether we actually produce the emotion or not, we must direct its expression. What we (the real personality that is spirit in its nature, and the actual "us") will to do through our physical body, whether in love, hate, or whatever, is the subject of God's interest and divine Word. Let the one having ears to hear, listen in!

(8) The Lord now asks a question of those listening about the famous king of Israel, David. Read Matthew 22:41-46; Mark 12:35-37 and Luke 20:41-44. The reason for the question was that the people from the apostles down through all the rest held false concepts of the Messiah (and his kingdom, naturally). They carried too much of the idea of an earthly empire like David's or Solomon's. This question Jesus asked spotlights the divine/human nature the Messiah was to have. Hence it was to be that David's son was to be David's God. Paul described this deity/humanity combination in Romans 1:3-4. We do not read that Jesus explained how it was to be; He just stated it for all to accept it upon trust in His word.

It is worth calling to your attention that Jesus taught David was Spirit-led to write the words of at least Psalms 110:1. The New Testament does not equivocate in regard to the inspiration of the Old Testament, and many times such ideas as we have here are stated.

(9) The crowds were eager to hear Jesus, and He proceeded to warn them about false shepherds who were like hirelings, John 10, and only cared about their own interests. In Matthew 23:1-39; Mark 12:38-40 and Luke 20:45-47 is about as scathing a denunciation as is recorded

anywhere. Perhaps if we could see the tremendous hypocrisy of the scribes and Pharisees and the consequent results in the general religious life of Israel, which ultimately meant hell for many who otherwise would have gone to heaven, we might be able to appreciate much better the "why" of this sermon. We just have a difficult time seeing sin for what it is, and does. Sin pervaded the whole nation of Israel, for so many had allowed the "god of this world," II Corinthians 4:4, to blind their eyes. It is no accident that Paul warns believers about sin, hardness of heart, and the consequences, Hebrews 3:7—4:13 (read this text!).

The men whom Jesus denounced "sat in Moses' seat" —were one of the means to dispense the law. What they taught, the law, was to be observed by all who heard. Jesus is not talking about the accumulated interpretations of the Jewish scribes, but the law itself. The lack of translation into life of what they (the scribes and Pharisees) themselves taught was absolutely no excuse for those who listened to so live. We too have no excuse for failure to practice what we know is right whether others do or not, including those who teach us.

On the other hand, the flashing red light of James 3:1 should make every teacher count the cost of so great a responsibility. Binding unnecessary burdens on those listening, in various and sundry ways exalting self in society, (seeking the chief reclining seats!) and failure to live as we expect others (Matthew 7-12!) is contemptible if intentionally done. No one is to be more than an earthen vessel through which a message is channeled, for all have only one teacher or father. Jesus obviously did not forbid the use of the name "father" for common use. If He did, Paul's usage in such places as I Corinthians 4:15 and Ephesians 6:2; and John's in I John 2:13 are surely "anti-Christ." He meant that the relationship of one disciple

FINAL WEEK

to another was to be as a servant, v. 11, who did not seek the title of "my chief one" (rabbi) but rather a way to serve brethren. Hence, all important are motives (attitudes) about positions and titles. Some may make much of one who is teaching and/or serving, but what is forbidden is seeking the place of teaching and/or service for such acclaim.

The verse about phylacteries, v. 5, was in reference to Exodus 13:3-16; Deuteronomy 6:5-9 and 11:18-21; which was taken rather literally in respect to "binding" things between the eyes, etc. So little leather boxes containing portions of the law were worn between the eyes and on the arm. Naturally, these soon became hallmarks of "the religious" among the people. Such importance was attached to phylacteries that the rabbis taught they were one of the things which could be snatched from a fire on the Sabbath.

One of AEsop's fables was that of the dog in the manger which would not allow the stock to eat the hay even though the dog itself did not eat hay either. Such describes verses 13-15, which show the purposeless enthusiasm and misdirected energy of the scribes and Pharisees as far as eternal values were concerned. Someone remarked about the proselyte: the more converted, the more perverted.

These verses use the word "woe" which occurs seven times (eight if you use the King James version, which has v. 14, an interpolation from Mark 13:40 and Luke 20-47). The word carries the idea of sorrowful pity, as one who is witnessing a tragedy but powerless to stop it. Certainly verses 32-37 convey the idea that such hypocrites as Jesus was denouncing could not escape condemnation to hell if they did not repent. Opportunity always carries responsibility, and so these men, with such tremendous places of service, were to be held more liable, Mark 12:40b.

An old saying goes, "There is more than one way to skin a cat." Verses 16-24 elaborate that such a principle of practice is at least as old as the first century. Matthew 15 and Mark 7 had mentioned some ways of avoiding the law that one did not want to keep. These verses point up the same sort of thing: weasling out on one's word. The unsuspecting, no doubt, were numerous who fell into the trap of the Pharisees and scribes, a trap that hinged on the backing for an oath. These men had decided that if one invoked an oath upon himself, and used the temple as surety, he could fail to keep his word and not be the worse for it, as they figured. But if the gold of the temple, etc., was used, then the man was bound to keep his word.

Jesus pointed out the hypocrisy of such practices, showing that all things were ultimately traceable to God (as also in Matthew 5:33-37). This sort of practice is yet around. That is the reason that Jesus (also James 5:12) forbid any oaths unless the law demanded such, and enjoined the Christian to make his "yes" mean "yes."

As further evidence of these "fools" (the same Greek word as is used in Matthew 5:22) character, Christ accused them of not doing the really important concepts of the law, but observing the less important things in the external realm such as tithing. He might well have added the "great" commandments to the list of justice, faith and mercy, all of which were absent from the lives of these men and without which God is not pleased, Micah 6:8. How perverted the men were is shown by His rather lucid illustration of the knat and camel, both of which were unclean to the Jews.

Tithing is mentioned by Jesus as something the Jews ought to do. However, they were obligated to tithe as the Mosaic law commanded it of them. But for preachers and others to take this text and apply it to Christians is

FINAL WEEK

poor exegesis, to say the least. We have been freed from legalism, and tithing is legalism. Those who use the Old Testament or any part of it (such as Mal. 3:10) to enforce tithing upon Christians are poor scholars in such efforts. There is not one text in the whole New Testament that expects Christians to tithe, and to use some Old Testament text to prove it is to do as badly as the groups that enforce Sabbath-keeping upon people from the Old Testament. We surely ought to practice that which we purport to teach, and that is we are New Testament Christians. To use the Old Testament, or texts like this one from the Gospels is to do the same thing as the men sought to do in Acts 15:1ff. The same sort of treatment for such attempts ought to be accorded those who do such things as was given those in the Acts passage: whole-hearted resistance. No one affirms that the Christian is not to give, for such is taught in the New Testament in plenty of places. All we affirm is that the law of tithing is not any part of the Christian life. Tithing may be a good practice, or percentage to give, with that we are not arguing. We are opposing such things as laws, however. We suspect that the current success of the faith-promise movement among Christians in general is what could happen anytime people are freed from the idea that some law governs their giving, such as the law of tithing. Cause a person to fall in love with the person of Jesus, and to give themselves to Him, and their giving will take care of itself (Read the passage in II Corinthians 8:1ff., and see if that is not what the Macedonian brethren did, which resulted in plenty of offerings. We can do the same thing, and to some extent are doing it, when we teach people that they are to trust God to help them give what is needed, which He will do if they give themselves to Him. This putting giving on the basis of love and need is the secret of success in the faith-promise movement).

Externals are only pleasing to God when they actually represent the inward man. Such is the point of vv. 25-28. The outward appearance is important as that is what (and all) men can see, but God knows our inward state, and that is eternally important.

The reference to whitewashed tombs is interesting, as anyone who had an unmarked tomb was expected to mark it in some way, especially so just before Passover time that men might not become defiled by it (see Luke 11:44; John 11:55).

The last "woe" was directed to people who had in practice mimicked the very worst of their father's deeds. As had been previously pointed out by Jesus, Luke 11:45-52 and 13:34-35, the generation of people in His day generally were "chips off the old block" in respect to reception of God's messengers. In fact, the heir had come, and they were planning to kill the heir, Matt. 21:33-43. Hence, they stood condemned, Jn. 3:36, and the sentence was just. God had drawn lines before, as in the forty years wilderness wanderings and the Babylonian Captivity, and they were drawn again. Constant rejection ("How often would I, but you would not") brings one into a state of the unpardonable sin, Matt. 12. Jesus could see that this generation as a whole was in such state. Thus the reason for a part of what He teaches in Matt. 24, (12).

(10) The widow's mite (Mark 12:41-44; Luke 21:1-4), so familiar to most, is a shining example of giving, far exceeding any tithe, and actually exhibiting the real "spirit of the law". (By the way, do you see the connection between the idea of "spirit of" and the fact that the real "you" is actually a spirit being?) To be commended by Jesus was something, and this lady understandably was a refreshing person among a multitude of external law-keepers.

FINAL WEEK

There is no real accurate way of discerning just what any coin used in Jesus' day might equal in ours, but we give the following list more for purposes of understanding the relationship between coins of that day than in our day.

The Greek word translated here is known as a lepton. It was the smallest coin in value used then. We list the following with at least one reference if possible, and some of the various ways the Greek words are translated.

mite (coins, copper coins, coppers)—worth 1/16 of American penny.

farthing (penny)—worth 1/2 of a penny, Matt. 10:29; Luke 12:6.

denarius (penny)—worth .08, Matt. 20:2; John 6:7 (a day's pay).

drachma (piece of silver, silver coin)—worth .09, Luke 15:8.

didrachma (piece of money, shekel)—.28, Matt. 17:27 (equal to Hebrew shekel, the half shekel was the yearly temple tax.)

mina (pound)—9.60 (or equal to one hundred drachmas), Luke 19:13.

talent—either silver or gold, and of varying weights, hence varying amounts of money.

The reader may consult various sources, and none agree among themselves as to the exact value of each of these, though some agreement exists about various ones of these listed. Hence the above list should be considered in this light.

(11) In many ways, some of which we have pointed out, Jesus was cosmopolitan. Some Greek people, perhaps proselytes or people interested in being so, were at this

particular Passover. They contacted Phillip (who had a Greek name) about seeing Jesus. The records do not say whether they ever got to see Jesus or not, but the lessons Jesus gave as a result of their inquiry not only comprised a great challenge to total service, but also formed the final public discourse by Jesus. Much private teaching was done after this, but none in public (that we have recorded).

The lesson Jesus taught in vv. 23-26 was that the only possibility of increase in the vegetable world of nature was through death, as that of a grain of wheat. Certainly wheat will not grow unless in some means it gets in contact with soil (or its equivalent) and moisture (wheat three to four thousand years old has been found in Egyptian pyramids). Such was also the way, Jesus taught, that His kingdom would increase. He would give his life for the increase of the kingdom. All who followed Him must lose their life in His by following Him.

Much the same lesson had been taught at different times however, such as Mark 8:34-38, that self-gratification brought no gain. Verse 26 uses Greek verbs in the present tense which, in the particular mood Jesus uses, teach that the ones who are His servants must keep on following Him. Hence, no service without sacrifice. Self must die, that new life can be produced.

Now read v. 27 in your version, as any will at least present some rendering of this text. It is definitely a problem to translate, though the surrounding context may help decide the more probable rendering. This is why you need to keep in mind what Jesus said, both before and after it.

Christ had expressed the thought of death. He knew His own was soon to happen. He then said, "My own life is even now troubled (had been and still is)," and "what shall I say?" So far, so good. However, the next

FINAL WEEK

sentence though not difficult of translation is hard to understand. Should we consider that it is 1) a suggested response He might make to the preceding question, 2) a rhetorical question for the sake of discussion, 3) a command, indicating that He does not want to die, or 4) a prayer, much as that in Gethsemane, Math. 26:39 and Mark 14:36? Each of these possibilities has its adherents. The first possibility is less likely than any of the rest. The second is a form of teaching (like Romans 6:1) which could have been followed up by the denial and commitment to God in verse 27b and 28. The third is distinctly possible, since He was human, and emotionally unwilling to endure the cross, though He would not change His mind. The fourth is echoed again in Gethsemane, and only the conditional "if you will" is left out, and could be understood in the light of the garden utterance.

God was very much aware of His Son, and promptly answered. Some could not decide what had taken place, so Jesus informed them, v. 30. Whichever possibility Jesus meant in v. 27, v. 31-32 definitely indicated His will for the future. He intended to bring life through His death. The cross, as John interprets for us in v. 34, is that avenue by which He will give himself. The reference to the ruler of this world and the judgment of it bring to mind ch. 14:30; 16:33. The sentence was in effect on both sin and Satan. The cross was the end of sin's dominion, I Cor. 15:55-57.

The question of the crowd may tell us that they equated "Son of man" and "Messiah." If He was to die, as they understood Him to say, how was it possible for the equation to be true, since the Messiah was to remain, as they thought. The old problem: false concepts of the nature of the Messiah.

Jesus' reply in v. 35-36 was intended to tell them that the opportunity to follow what they could "see" was theirs, and to follow while opportunity presented itself.

Vv. 37-43 inform us that the public ministry, with perhaps the exception of vv. 44-50, is over. The remaining chapters will record private ministry and the events during and after the death on Calvary. These verses also inform us that the rejection of Jesus was not unlike that in other times, and was one of the fulfillments (see Acts 28 for another) of Isaiah 53:1 and 6:9-10. The texts in both Math. 13 and Acts 28 show that the predicted unbelief was because the people willed it to be so. The passage in Romans 10:18-21 is a good parallel to this text. God has so willed the affairs of men that though men may have free choices in respect to obedience or disobedience of His will, the results are already determined. To refuse is our privilege, but it brings a consequent hardened heart, and the final end, if the will is not changed, is death in hell. The state of mind that would bring such a result can be seen in some of the authorities, as John wrote of them in vv. 42-43. Self had not died for them, and no life would be forthcoming until it did!

A sad day for Israel was the day Jesus uttered vv. 44-50. The basic ideas had all been presented before, that of 1) Jesus' relationship to God, with the 2) consequent relationship of Jesus and what He had taught to the world, and 3) the consequent condemnation (note v. 31) of those who refused what He had taught. And the majority of Israel was among the last.

(12) (13) This section, Math. 24:1-25:46; Mark 13:1-37 and Luke 21:1-36, begins a private ministry of teaching that extends through John 13-16, as well as the teaching done after the resurrection. Within this section

FINAL WEEK

Jesus develops a rather extensive description of the end of the Jewish nation and Jerusalem, His second coming, His relationship to His disciples and theirs to Him, and the Holy Spirit's person and work.

The immediate text deals with 1) the end of Jerusalem, and consequently the destruction of the temple, with the effect these things would have on the Jewish nation, and 2) His second coming and the end of the world. The following outline of the whole section will present the text as we view it.

There are no solutions to this section that are without their problems, both exegetically and theologically. Whatever view of the millennial problem one holds will inevitably determine some exegesis here. As before stated under #64 (4), there are no authorities in interpretation (See the article "Interpretation" in selected studies). The best method of interpretation is an inductive method, which ascertains all the facts and then draws a conclusion. It has its problems, obviously, since the facts may be overlooked, misunderstood or misevaluated. We hence always should remain interested in any view of anyone, since no one has a corner on all the truth, and definitely not how it should apply in every circumstance.

When the Master left Jerusalem, the disciples made some remarks about the beautiful temple. Herod the Great had worked on it for some twenty years prior to his death, and work had continued over the intervening thirty years up to the time of our text. It was completed in A.D. 64, just prior to its final destruction by the Roman army in 68-70.

In their response to His surprising expression about the city, they asked and He answered four questions. The disciples confused the questions because of their mixed-up concepts of the relationship of the Jewish nation to the kingdom. The identical problem yet exists, which is

why we have commented as we have already under such texts as Matt. 21:33-45.

Perhaps some few comments are pertinent. The oft heard remark about "wars" and "rumors of wars" was not said in connection with the second coming of Jesus at all. It is not right to so quote it in that light. Besides, what sort of a sign is something that always happens? As the point about Noah shows, it will be life as usual when Jesus comes, not unusual.

One problem with the analysis presented of the text is the interpretation of the word "immediately" in v. 29 of Matthew. As we have interpreted it, Jesus used it differently than we might use it, since it has been some twenty centuries ago. Yet, the New Testament writers invariably warn that the second coming is to be expected any moment (and life thus lived in this light, James 5:7; II Pet. 3:1-18); so maybe that is how Jesus meant for it to be understood. The second epistle to the Thessalonians was written because the people had understood Paul to say that Jesus was coming right away. But there is no other way to teach about the second coming except to teach that it is to be expected anytime.

The following arrangements of the disciple's questions as Jesus answered them, with the texts for each answer, is given.

THE QUESTIONS

Math. 24:3

Mark 13:4

Luke 21:7

1. When is the end of Jerusalem?
2. What is the sign of the end of Jerusalem?
3. What is the sign of your coming?
4. What is the sign of the end of the world?

FINAL WEEK

THE ANSWERS — ABOUT JERUSALEM

1st question as to 'when'

Math. 24:4-14 Mark 13:5-13 Luke 21:8-19

2nd question as to 'what sign'

Math. 24:15-28 Mark 13:14-23 Luke 21:20-24

THE ANSWERS — ABOUT 2ND COMING

3rd question as to 'sign' of your coming

Math. 24:29-31 (vs. 27) Mark 13:24-27 Luke 21:25-28

4th question as to 'end of the world'

Math. 24:37-25:30 Mark 13:33-37 Luke 21:34-36

Note carefully the review and contrast in the two different events as recorded in Math. 24:32-36; Mark 13:28-32; and Luke 21:29-33. ("this" vs. "that")

Consider carefully what Jesus teaches about His second coming:

Parable of master and the thief—time unknown, so danger

Parable of faithful steward—time unknown, so duty

Parable of the porter—time unknown, so loyalty

Parable of 10 virgins—time unknown, so be prepared

Parable of talents—time unknown, so be wise

The days of Noah are like the end of the world (and 2nd coming): *fact* of rain was certain and sure, but *when* the rain was to come was *uncertain* and even *unknown*. Note vs. 37-38 "until the day . . . they did not know."

The description of the Judgment: each is *rewarded* as life *required* (Math. 25:31-46). Jesus said: Do not let this life divert you from faithful service. Each one has his work. What I say to you (apostles) I say to all: watch at every season.

The value of parallel accounts is again apparent, when Matt. v. 15; Mark v. 14 and Luke v. 20 are compared.

When Jesus spoke of the terrible suffering among the Jews when the end came, His prophecy is borne out by the Jewish historian, Josephus. The man was in command of a part of the Jewish army in North Palestine, and when the Roman army captured him, and moved on to Jerusalem, he was taken along. He witnessed the siege of the city by the Romans, extending over a period of some two years, and thus wrote from an eye-witness viewpoint. Among other things, he told that the Romans crucified so many Jews that wood for the crosses was exhausted. So they impaled them, or did other things as terrible. The dissension among the Jews inside the city became so great over the long period of time, that they warred among themselves, and one faction finally opened the gates and let the Romans in to take the city.

He also chronicled the fact that the Jewish Christians as a group believed the warning of Jesus in this section, and many left the city early and fled across the Jordan to the area of Perea, thus escaping the slaughter in the city of Jerusalem, where many had fled for safety.

A comment about v. 14 of Matthew is in order. Read Col. 1:6 and 1:23. This epistle was written about A.D. 63, just prior to the fall of the nation, and the prediction's fulfillment. As you meditate about the fall of the nation, reread Deut. 28:58-68.

We pointed out in the discussion of Luke 17:37 that the Greek word in v. 28 of Matthew would be better translated vultures than eagles, since eagles do not eat carrion.

Many in the theological world have projected theories about the second coming of Jesus, using Math. 24 and Daniel as a basis. Perhaps a comment here will be thought-provoking at least. Jesus had access to the book of Daniel just as we do, plus any or all of the other books in the Old Testament (not to mention the fact that He

FINAL WEEK

directed the writing of these books). He was the person who gave the information in Math. 24. Now if he could not figure out the time, from all this information which men use today, of His second coming, one might do well to hold all such attempts by other men as a bit doubtful, if not a waste of time, would you not say?

Another item of interest is the repeated use of the flood as being an actual historical event and in some ways an illustration of the status of things at Jesus' second coming. Other passages dealing with His second coming are Math. 13:36-43, 47-50; Luke 12:35-40; I Cor. 15:51-52; I Thess. 5:1-11; II Thess. 1:5-2:11; James 5:7-11; II Peter 3:8-14.

As you read the various illustrations Jesus gave concerning His second coming, note that all convey an idea of "soon" but "unknown" with respect to time. Did you catch the same drift in the passages from the epistles? Each illustration or comment describes a possible time to prepare even if the exact time of appearance is not known. Hence, the present imperative form of the Greek word in v. 42 (the same in 25:13) is most important: "keep watching!"

The theme of judgment is likewise present. It could not be otherwise, for life on this earth is over, and the life with no end begins. Hence, John 3:36 becomes most meaningful to this discussion. Time to change will be over, for time will be over. The deeds done in the physical body will determine the future without end, II Cor. 5:10. The parables of the ten virgins and of the talents highlighted the idea that no excuse for being unprepared was acceptable, and all were to be judicious in the stewardship of time. You see, judgment not only will involve use of things, but use of time in regard to those things. Hence, each of the parables or illustrations pinpoints some one facet about the second coming, as

the outline above shows. The judgment scene in 25:31-46 only enforces the idea: how you let your faith work decides which eternal state you will experience. Varying degrees or number of "talents" are unimportant—all have equal responsibility in respect to that which is entrusted to their care.

The mention of the preparation of the kingdom from the foundation of the world calls to mind such passages as Eph. 1:3-14. The remark about the place prepared for the devil and his messengers, v. 41, perhaps implies that God never intended for anyone to perish, II Pet. 3:9, and did not prepare hell just so people could be condemned to be there forever. The reader may wish to read the article in the selected studies on death for discussion about punishment forever for the wicked.

(14) The texts of Matt. 26:1-3, 14-16; Mark 14:1-2, 10-11 and Luke 22:1-6 recount several items of interest. One of those is that each of the three accounts mention the upcoming feast called The Passover and/or the feast of Unleavened Bread. Luke's account clearly shows that the two terms can and/or did mean the same thing, depending on the frame of reference. This may help in the understanding of a passage like John 18:28. Another point to be remembered is that the discussions in the temple apparently occurred on a day which was two days prior to the beginning of the feast. For discussion of the actual time of the Passover, see under point (15). A third item to remember is that Luke specifically points out that the decision of Judas to betray Jesus occurred at this juncture of time (in Luke's words, the Passover was *near* in time, the other two accounts are more specific). The decision of Judas to deliver Jesus to the rulers in exchange for thirty pieces of silver (an unknown amount which the rulers weighed out to him in the most orthodox way. Note their thinking in Math. 27:3-10)

FINAL WEEK

perhaps was made at the anointing of Jesus by Mary some three or four days earlier, and the inclusion of the event by Matthew and Mark help in understanding his action, since he was indirectly chided by Jesus for his attitude and was not able to get his hands on the money, which he could "see" being poured out of an alabaster box.

We have pointed out before that the rulers were not willing to accept Jesus, though the people were. This text spells this situation out in detail. You can easily appreciate the great advantage the action of Judas gave the rulers. They could go to the Garden of Gethsemane late at night and know that Jesus could be taken without a lot of people around. They may have first gone to the upper room, since Judas knew where that was. (No one but Peter and John knew until they got there, doubtless a precaution taken by Jesus, since He knew of the contemplated action by Judas.) But Jesus and the disciples left before the night was over, so the garden became the place of arrest. After the arrest, the hasty trials and sentence could be over barely after sunrise, and the crucifixion by 9:00 a.m., because Judas so acted. We might add that Luke's account states that Satan entered into Judas at this time. John 13:27 also mentions this idea when two (?) days later at the Passover supper, Judas refused to accept the chance to change his mind, and decided to go through with the betrayal. However, the fact had been pointed out almost a year earlier that Judas had so given his life over to the devil that Jesus used the Greek word that elsewhere describes Satan in reference to Judas, John 6:70. He had called Peter Satan in Math. 16:23. Did he consider that anyone who refused to do what was godly became a henchman of the devil in that moment? What about the remarks in John 8:39ff. along this line? Jesus mentioned in John 14:30-31 about the

relationship He sustained with Satan—that He had ever refused to allow any deviation in His life from God's will, thus Satan had no power over His life. Read again Matt. 12:43-45.

(15) The Fourth Passover—the accounts in Matt. 26:17-19; Mark 14:12-16 and Luke 22:7-13 pinpoint for us 1) the fact that only Peter and John knew where the room was in which they would prepare the feast, as Jesus did not specify anything definite to them except that a man unnamed would have a room prepared and that a man carrying a jar of water was their means of finding this man, 2) the day on which this was done was the day which was called the first day of unleavened bread. It was called this since all leaven and anything with leaven in it had to be removed from the house in preparation for the Passover Feast, Ex. 12:19. The account in Exodus 12 specifies only three items were required for the feast: a lamb, unleavened bread and bitter herbs, v. 8. Nothing else was demanded—hence those who say that Christ drank fermented wine at the Passover Supper because the drink had to be that simply do not say what the Bible said. Any kind of drink or none at all could be used. We are anticipating the events a bit, but the accounts never say that Christ took wine and used such to institute the supper. Rather, all the accounts describe the drink as the "fruit of the vine." See under #17 for other discussion on wine.

We call the reader's attention to the fact of a definite set of standards the lamb sacrificed had to meet. By Jesus' day, the priests were selling the lambs which they approved, and it soon became such a business that Jesus had to attempt to stop it twice in four Passovers. Annas and his family made a lucrative business out of the temple. The priests could reject any lamb brought by a family

FINAL WEEK

for sacrifice, and the only recourse would be for the family to buy one from the flock the priests had. Neat, huh?

Actually, the thirteenth of the month, Nisan, was the day when the house was cleaned of leaven; the lamb killed in preparation for the night's feast, along with the bread and herbs. The fourteenth, the house was ready for the seven days of leavenless food.

When the fourteenth of Nisan occurred is a definite problem. The Jews held that the first appearance of the new moon was to be the starting point for the new month. The moon would then be full at the beginning of the feast on the middle day of the month. However, the means of determining when that new moon appeared is not easy for us to find out from this point in time, nor even for the Jews in that time. The normal custom seems to have been (according to Edersheim, *The Temple, Its Ministry and Services*, pg. 200ff.) that the Jewish Sanhedrin met on the day following the twenty-ninth day of each month, and upon the testimony of credible witnesses, determined if the new moon had been seen or not the preceding evening. If, according to the witnesses, the moon had been seen the evening of the twenty-ninth, then the Sanhedrin declared the new month had begun. If no such testimony was forthcoming, then the month was declared to begin at sunset of the day of the meeting. Hence, we cannot determine what the Jewish Sanhedrin decided in regard to the year in question.

The only way we can even get close to the day upon which this particular feast began is by the record of the New Testament writers. The lambs were sacrificed by the temple priests in the afternoon prior to the fourteenth day. The Jewish custom of deciding that evening had begun (and a new day) when the first three stars were seen may have been followed by those at this feast. At any rate, the lamb, unleavened bread and bitter herbs

NEW TESTAMENT HISTORY: THE CHRIST

were to be consumed by morning. But at this feast, the evening and morning of what day, as we reckon time? Consider the following ideas: 1) John 19:14 specifically states that the crucifixion occurred on the day called the Preparation. Friday was this day. Since the Sabbath always fell on Saturday by our calendar, the day preceding (Friday) was the day to prepare for the Sabbath. In Jewish circles, it came to be called the Day of Preparation (and still is by some Jews) easily enough. 2) Now turn to Luke 23:54 and Mark 15:42, and you will note this exact fact is recorded by both. Luke 23:56 notes the Sabbath followed the day called Preparation and in 24:1, the first day of the week (Sunday) followed the Sabbath. Three successive days occurred then, the Preparation Day, upon which Jesus ate the Passover, was killed and buried, the Sabbath, upon which the women rested, and the first day, upon which the women came to the tomb to find Jesus who was not there but resurrected.

Now some have argued over the centuries that Jesus ate the Passover Supper early, so that 1) He might die at the exact time the paschal lambs were being sacrificed in the temple. However, there is nothing ever implied in the relationship of type to antitype that demands this particular thing must occur. Or 2) because He had prophesied that He would be in the tomb three days and nights, that the crucifixion must have occurred on Wednesday, in order that the literal three days and nights might be fulfilled. There are several good reasons why this is rather improbable and even false.

One is that the Scripture does not use the idea of days any more closely than we do. We noted at Luke 13:32 that Jews obviously did not mean three literal days. We must decide what He meant by it in Math. 12:40 and other places where He used it. Consider Gen. 43:17-18 and I Kings 15:1, 2 and 9 as an example of reckoning

FINAL WEEK

time. Secondly, sometimes the gospel writers record Jesus as saying "on" the third day, while at other times they record the idea of "in" three days, or "after," John 2:19, 20 (the rulers understood Him to say "within" three days); and Math. 27:63-64. In this last passage, the rulers used a Greek conjunction which may mean until, while, up to, as far as, or various similar ideas. Did they then mean three days from the day of burial, the day after when they were talking, or what? Note the statement of the men in Lk. 24:21, then read I Cor. 15:4.

Consider this idea which we have urged before, that Jesus never broke any Old Testament commandment. Now if the theory put forward by some be correct, He did not eat the Passover at the appointed time at all, nor did His disciples. Too, the eating of the Passover early would necessitate the killing of the lamb early. Which priest or Levite do you think would do that (especially if he knew it was for Jesus!)?

We do not use the expression under consideration to mean exactly seventy-two hours, rarely, if at all. We will specify the hours in mind if we intend for the period to be exact. We note that the accounts do not make a point of telling just when Nicodemus and Joseph placed Jesus in the tomb. As far as the women were concerned, He was not completely annointed yet—was He considered buried or not?

Another thought: since the resurrection obviously occurred after the Sabbath was over, or after sunset in the evening, if we take the three days and nights to be seventy-two hours, no more and no less, (as some insist they must mean) counting back from some time after sunset in the evening (the accounts do not say when Jesus arose, only that He was gone when the women arrived. So anytime after sunset in the evening He would have arisen on the first day of the week) would take us

to a point of time on Wednesday, but after sunset Wednesday, our time. But the accounts plainly teach that Jesus was buried before sunset. Thus the time span is greater than seventy-two hours. So it does not fit the facts.

Some argue that the first (and sometimes last) day of the feast was called "Sabbath," because it was a day upon which no work could be done. But the Bible does not call this day by such name, and the Hebrew word does not mean "Sabbath." It conveys the idea of a holy day in nature, and is better translated convocation. So that idea is not very sound, either.

We conclude that the view of the church over the years is correct, that Jesus ate the Passover Supper at the proper time, the fourteenth of Nisan, was crucified that same day and buried before sunset. The day following this Friday (called the Preparation) was Saturday, a Sabbath Day. Sometime after sunset (which closed this Sabbath day and began the first day) Jesus arose, as He prophesied. From this perspective, we must understand His expression "three days and nights." The major emphasis, in Math. 12 or elsewhere, is that He would be killed, buried and resurrected. Those things were done, and we may rest our faith in Him, Whom sin could not conquer, and death could not hold.

(16) and (17). The upper room brings us to the section of the Gospel accounts that is replete with grand themes to study, great subjects to ponder, and difficult ideas to grasp.

The text of Luke 22:24-30 apparently recounts an incident which occurred about the beginning of the evening's activities. We may imagine the sunset, and through the last rays catching a glimpse of the disciples on their way to the room and feast prepared. Perhaps the thought of reclining at the table, and the various positions each might have in respect to Jesus brought about the never-

FINAL WEEK

ending argument about who was the greatest (see under Math. 18). Jesus surely must have winced as the men, thoughts on themselves, argued about the subject, while He was on the edge of death itself. He again had to point out that service is the highwater mark of greatness and the footwashing in John 13 reinforces this principle. (Perhaps even resulting from this argument. The obvious humiliation of Jesus in so doing would not be lost on these men, who would doubtless be chagrined by the rebuke given, both by word and deed). False greatness was everywhere around them. They needed to adhere to Jesus, as they had in the past days, and all they could imagine, and more too, would be theirs. Loyalty is honored in God's kingdom.

John's section from 13:1 - 17:26 is so full of subjects that the scope of this book will permit only a small amount of discussion on each one.

The section opens with several assertions about Jesus, 1) He loved His disciples prior to the feast of the Passover, 2) He knew His impending death was at hand which preceded 3) His return to God. The text does not assert that He ate the Passover Supper before the proper time, as some teach. It simply asserts that Jesus had love for the disciples prior to the time of the Passover, and the events on the morrow were but a prelude to His departure for heaven.

V. 2 in the King James version is badly misleading. The words "being ended" (the Supper) are quite incorrect. The Greek text means "during" or "while," thus placing the footwashing in the midst of the feast, not after it, even as v. 4 shows. We refer the reader to the comments on Luke 22:3 for Satan and Judas.

The reader may know that the custom of the day was that people reclined on one side, rather than sat on chairs, to eat. The common pictures of the last supper

are untrue in this regard. The arrangement of the men at the table is not stated, though a few things are implied.

The text in John 13:24-26 probably tells us that Peter was not close enough to either John or Jesus to ask what he wanted to know. John was reclining on the mat immediately in front of Jesus (that is what "lying close to the breast of Jesus" means). Why Peter beckoned is not clear, though the above position mentioned might show why he did if Peter did not want others to hear his question to John (or maybe John's answer also). So we tentatively locate Jesus and John together, with Peter reclining in a place where John could see him. The only other person whose location is possibly given is that of Judas. Considering the exchange of words between him and Jesus, and the failure of the rest of the disciples to know whom Jesus meant by His "one who betrays," it seems likely that Judas was close enough to Jesus for them to talk, perhaps reclining immediately behind Christ, but not for others to hear. Read Matt. 26:25 in this light. If the disciples did not hear this exchange between Jesus and Judas (or that between Jesus and John, mentioned above), then the result in John 13:27-29 would be possible.

"Deity serves!" Jesus said, "My Father is busy until now, and I am too," John 5:17. The character of Jesus was yet an enigma to the disciples, even though He had tried to explain it in various ways. One can hardly expect Peter to react differently than he does, v. 6, 8. But Jesus quickly pointed out that refusal to accept what He wanted to do severed disciple/master relationships. That fact is still true! The response of Peter in v. 9 is no better, for he is still telling the Master what to do. The primary requisite to becoming a disciple of Christ is submission. It is also the basic ingredient to remaining a disciple.

FINAL WEEK

Peter was so in error, but Jesus loved him anyway. Such is also the case with any disciple, we presume. Peter's heart was in the right place, though!

The act of Jesus, as He laid aside His outer garments, and began to wash the disciple's feet, is a clear example of the way those who follow Him are to do. We are commanded to do *as* He did (be willing to minister in behalf of others, regardless of what that service is), not necessarily what He did, though nothing would be wrong with so doing. In some cultures today, even as then, this gesture would be a sign that the host was cognizant of the physical needs of his guests, if walking were the common means of travel. Hence, we think it not strange that I Tim. 5:10 contains the idea of footwashing. It was a common cultural courtesy of that day. It is the principle of humble service that is expected of the disciple, however it may be expressed in daily activity.

The lesson Jesus emphasized was that the desire for greatness must be preceded by a knowledge of what true greatness is, and then the life so lived as to accomplish such. One never gets too great to serve, we learn. Nor does Jesus' humble service deny His authority. Hence, the one serving others need not consider that the station he occupies in life is degraded by serving others, regardless of what they may think. The disciple represents Christ as he goes, and if any feel offended by the disciples' willingness to serve and reject the disciple, rejection of both Christ and God takes place at the same time. Luke 10:16 contains the same lesson in respect to the three-fold relationship of disciple/Jesus/God. The Master, the messenger and the messenger are inseparable, John 15:23.

Perhaps a remark about Jesus and Judas will be appropriate, as we consider vv. 18-19. Many times in the New Testament the accounts state that some act or event fulfilled scripture. Jesus remarked about Judas in refer-

ence to the betrayal that Scripture was being fulfilled. The question in reference to such things is this: did people do certain things because they knew the scripture had foreshadowed it, and they thus felt that it had to be fulfilled? or were they constrained to do so by God, having no choice of their own? or did their choices, known of old by God, simply bring about the fulfillment of a certain prophecy? What did Jesus mean by the statement in v. 19—that whatever Judas did was actually of his own free will, or that all he did was destined beforehand, and Judas had no choices? Note such passages as John 19:23-24, 34 and 37; Acts 28:24-28. The situation is changed, though, in respect to Jesus. What He did while on earth He had previously predicted through His servants, the prophets. Hence, He merely kept His Word.

“My body—My blood: for (each and all of) you!” The Passover meal having begun (Math. 26:20-29; Mark 14:17-25; Luke 22:14-23), Jesus took occasion to express His great longing to partake of the meal with the disciples, and pointed out that it marked a definite point in history. The fulfillment of the kingdom promised was at hand, and the message preached by the prophets, John and Himself, was about to be replaced by a new one; the king is on His throne (and the kingdom has a new constitution for its citizens).

The use of the loaf of unleavened bread to represent His body, and the cup of juice from the grapevine to represent His blood were acts of lasting importance. The communion service is one of the ways to recall the sacrifice of Christ on behalf of every person. As John 3:17 states, that was the primary aim in Him coming to earth. The elements Jesus used were of a simple nature, doubtless meant to keep the partaker's thoughts off the elements themselves and on the actuality they represent. Whether we can ascertain if Jesus meant for these ele-

FINAL WEEK

ments, and these alone, to be used in the communion service is difficult if not impossible to decide. Though we are unable to decide how much bread to take, whether it was taken from one piece, or already broken up, or whether the juice was hot, cold, strong, weak, etc., we can mostly certainly use these and rest assured they will help us recall our Savior. That is important wherever, however or whenever we observe the service. To recall the fact that sin demands death, and the sin of all was represented at Calvary in Christ (II Cor. 5:21) is the crux of the memorial. Sin's penalty was not repealed by God—Christ took the penalty, and with His stripes sin was healed. His death, represented in the memorial, is the basis for any hope we have for God's mercy, and faith is the means of appropriating it.

Thus Jesus taught His small group that His blood was shed *for the purpose* of sin's forgiveness (by the way, the Greek text is like Acts 2:38—and both indicate the purpose of the preceding action. Here, Jesus' death for the purpose of remission of sins; there, the believer's repentance and immersion for the purpose of remission of sins).

The harmony outline indicates that Judas left before the institution of the Lord's Supper. A careful perusal of the accounts will seemingly indicate this fact, though the reader will note that John's account does not record the institution of the Supper, while the synoptics do not record that Judas went out, though all record the fact that Jesus spoke of betrayal by one of them. John's account does not say at what point Judas left in relationship to the meal. Paul's account in I Cor. 11 states that the juice representing Jesus' blood was not given to the men until the supper was over, though the emblem of the bread was given during the meal. So we

do not know if Judas was present for any of this, or all of it.

Judas gone—Jesus glorified: is there any connection between the two? When Jesus spoke of glory, He had direct reference to His death. He did not teach us to glory (or even remember) in His birth. But when a friend has gone to betray Him, and Calvary is hard upon Him, then He is glorified. Judas had left to bring about that death (though he may have understood very little that such would actually happen) even though Jesus had tried to prod his conscience into action, and get his mind to change. One can but ask if Judas' life does not in some aspects forshadow ours—he gloried in other things than Jesus, and caused death. But we have also done such, and Jesus died because of us, too. Perhaps we should not exonerate Judas, nor self, but how little we understand the magnitude of our own choice for self over Christ.

John 13:31-38 contains a most familiar text, and yet, though centuries have come and gone; its depth of meaning always beckons the disciple. We can but admire Peter—he really did not understand His master (even as we also fail) but none can deny his love, nor find fault with his "I will give my life for you." Could we who meditate on this thought find the resolve in our life to so love!

Jesus spoke of departure, and Peter wanted no part of such a thing. Yet, growth demands that we "make it on our own" in some ways. Faith is not a product of possession, but rather of evidence (Romans 8:24-25). The disciples only knew the amount of faith they had when Jesus left. So it is with every disciple.

Dark sayings in reference to betrayal and death, rebukes for seemingly innocuous requests, refusal of acclaims in one place and time, defense of such at another, thrones, servants, life, death, love, denial—all doubtless

FINAL WEEK

were present in the minds of that small group of men in the upper room. No great wonder that the text found in John 14-16 was spoken by Jesus to those men.

These three chapters outline Jesus' care for these men, how fruitful they can be through Him, and how victorious in their life because He has provided the way.

Consider some of the provisions Jesus mentioned: personal preparation for them 14:1-5, and the way to get it, 6-12; answered prayer 14:13-14 (15:7); another helper to take His place, 14:15-25; with assurances that the thing probably absent from their lives at that moment (peace of mind) would be theirs through Him, 14:26-31; assurance that His personal absence would not hinder a satisfying life, 15:1-11; nor indicate that they were aught but His friends, 15:12-17; and would but share the life they admired in Him, 15:18-16:4; confidence in the future both as to direction, 16:5-15; and a life-long experience culminating in joy perfected through being in Him 16:16-33, added the icing. All this, and heaven, too!

The response of the men in 16:29-30 is almost as hard to understand as anything they had said. What did they really mean? Did they not understand any of His extended discourse, or His references to the helper to come? Could they not share any or little of what He taught because they were too troubled in mind over their dispute about greatness, or the footwashing, or that abrupt exodus of Judas? Or had the various bits of teaching finally fallen into place as they listened, and now they felt the subtle implications of things Jesus had said and done had become meaningful? His obvious ability to anticipate their questions, the varied pictures He had drawn reflecting a particular aspect of their relationship to Him, and through Him to God—perhaps this was the burst of knowledge now theirs. It may be that they were finally convinced that Jesus knew exactly what they needed, and

their faith was in His knowledge (though not in their understanding)—such knowledge being so like God's that they accepted Jesus as from God.

Some study spent on the smaller sections of this large discourse will be rewarding, not only for gleaning information that can be applied to our own personal life, but also in increasing our knowledge of how much Jesus promised the disciples.

Those of you who do not read Greek will perhaps be interested in a few remarks along about the words Jesus used. 14:1 presents an interesting problem in translation. Some forms of the Greek verb are ambiguous (*every language* has some problems of this nature!) and only context can determine what is to be understood. John 5:39 is like this (see *in loco*). Various translators thus take the passage different ways, depending on what they believe the context is. As an illustration, the first verb translated "believe" can either be understood as a statement or a command. So also with the second verb "believe." Did Jesus mean that the disciples had faith in God, and they also did in Him, and this was to be continued (thus both verbs were to be understood as commands to continue the status quo), or that they believed in God, and they were to keep believing in Him (the first a statement, the second a command, etc.?). Hence no final decision that has no problems can be made. Each person must study the immediate context in the light of the larger context of the whole evening's session, and even in the yet larger context of the disciples and their relationship to Jesus and to God.

The Greek word in 14:2 (translated "mansions" in King James) simply means "dwelling place" and has none of the connotations of our word "mansion." The same word in the verb form is found in 14:23 describing what

FINAL WEEK

Jesus and God would do for those who love Christ and keep His word: make their home with such a person.

The Greek word in 14:16 translated "comforter" in King James means 'someone who can help.' Consider then all the ways the Holy Spirit was going to help the disciples, as you read 14:16-17, 26; 15:26; 16:7-15. List them!

In 14:18, the Greek word translated "comfortless" in King James is the word for "orphan" in Greek. So the promise of 1) the Holy Spirit's presence when He left, 16:7ff., and 2) the promise that both the Father and Himself would dwell with them, 14:23, would take the place of Jesus' bodily presence and be to their benefit. Only by such a method could Jesus be personally with the disciples everywhere, since the physical body would not limit Him as when He was on earth.

The word "peace" in our vocabulary has several ramifications (like most other English words). The Biblical usage very often is intended to convey an idea of a right relationship with God regardless of what the external circumstances might be. It carries little if any of the idea of "ceasation of hostilities" as is normally the case with us. With this idea in mind, consider 14:27; 16:33; Rom. 5:1; then compare Math. 5:3-12, where Jesus described the really happy man, with II Tim. 3:12. How do you now understand Math. 5:9? By the way, our English name of Irene comes from the Greek word in question.

Note that Jesus commanded the disciples to trust Him as actually being the embodiment (Heb. 1:3) of God, or to consider the deeds He had done in order to come to this conclusions, 14:8-11. The disciples' confusion of the relationship of Jesus to God was again shown to be deficient. The lesson of Math. 22:41-45 had not yet been understood by them. Jesus had expected them to deduce His deity through observation and reason

NEW TESTAMENT HISTORY: THE CHRIST

(see also Rom. 1:18ff.). Hence, if they wished to know what God would do or say under given circumstances, they only needed to "see" Him through Christ.

14:12 is a problem to some. We understand Jesus to mean that the new dispensation of grace which was inaugurated by Him would permit the disciples to "perform" greater things that He did. He could not usher people into the kingdom but only call to their attention that it was near, Mark 1:14-15. All who accepted Christ through the message proclaimed would become a part of the kingdom, characterized by light and God's power, Acts 26:18.

The promises contained in 14:13-14; 15:7; or as in James 5:13-15 should be understood in the light of I John 5:14-15.

14:15 (note that 15:13 is one of the commands to keep) highlighted the motivation for obedience. They would not obey primarily from fear, but rather because they had considered the loveliness of all Jesus is, and then gladly obey whatever He desired of them. Motivation and/or attitude was always to be the checkpoint for anything they did or encouraged others to do. Note that active obedience was the mark of love, v. 21, and love for Christ would habitually manifest itself in submission to His will, v. 23, whereas the habitual non-lover would not obey Him, v. 24. Nothing was thus said about or contemplated for the erratic "lover" because such a person did not really love Christ. The manifestation of Christ (the Holy Spirit and Christ are so alike that when the Holy Spirit came, it could be said that Christ came) to the believer depended upon 1) their knowledge of Christ, 2) acceptance of Christ through believing (having faith) in Him, so that 3) their love could be directed into doing His will.

FINAL WEEK

14:25-31 revealed that the Holy Spirit would complete the revelation of Christ's will to them, thus they were not to be troubled in mind, v. 27; 16:7-15. The disciples' understanding of Christ was not what it could be, which fact would necessitate added guidance. The failure of the devil to have any claim on Jesus' life was a glorious truth, but the disciples needed help (cf. Luke 22:31ff.), which would come through the Holy Spirit, so that they could resist the devil as Jesus had done.

14:31 seems to point up the fact that the remainder of the discourse was given elsewhere than the upper room. Perhaps the men arose and Jesus taught them on the way to Gethsemane, though it is difficult to place the prayer of ch. 17 in such a situation. Math. 26:30 and Mark 14:26 record that a hymn was sung before the departure to Mt. Olivet.

(17) 15:1-11 presented a beautiful picture, easily comprehended, of the necessity of Christ for the disciple and the disciple for Christ. The vine is dependent upon the branch to bear fruit, but the branch (the individual disciple) only produces by virtue of receiving life from the vine. Each disciple (branch) must then expect two things: 1) a drastic handling at the discretion of the vinedresser (the Father). Grapes are only borne on new wood, thus each year the old wood is pruned away, so that new wood can grow (how drastic God used His own Son so that fruit might be borne!) and 2) the determined will and expectation for life is to be a fruit-bearer. Anything else means that the "branch" will be removed from contact with Christ (the vine) and the fires of hell will have added fuel. Note the words in this text that describe a lifetime habit: v. 2 "bears," v. 5 "abides," v. 8 "hear"—all present an habitual disciple who is just that (a disciple) because of a willed contact by that disciple with Christ. No other "lines" are drawn

in the Scripture to describe a disciple except this one: service habitually, unto the culmination of physical life, Rev. 2:10b. Since God alone (the vinedresser) determines which branch is fruitless, only He knows whether the individual disciple (branch) is saved or lost. The disciple's part is ever to teach and exhort both self and others (Heb. 10:19-24) and leave it up to God to "draw the lines." If God is not willing that any perish, on His part, the disciple should be like Him in this respect. Each disciple should be glad if everyone went to heaven, should he not?

15:13-17 enlarged the idea of "how" the men were to love others who are Christ's—as 1) friends and 2) as Christ loved them. God had made the first move, and they had no merit to claim, only obedience to perform. Perhaps this section hit a trifle close to home, because this very evening love for each other had been conspicuous by its absence, and selfishness clearly evident among them.

15:18-16:4 presented the actual state of affairs in the "real" world—the world that Paul mentions in Eph. 6:10ff. The disciples, as are we, were easily led away from the reality of life. How the devil wins victories is to get one's thinking turned away from the actual reality to something secondary to it. This is done by getting us to not remember that any word we speak (Matt. 12:37) or any act we do (II Cor. 5:10) is related to eternity. There are no "vacuums" in life—no times or places in which the responsibility to *be right with God* are not present.

Because this is true, the disciples could take a cue from their master's life—the going would be rough, and some of that difficulty would come from those who would believe what they did was God's will. The rest of the N. T. is but one long illustration of just such as Jesus predicted. See here Acts 26:9ff.

Jesus mention in v. 26 that the Holy Spirit would bear witness to Him. However, there is no record of any such

FINAL WEEK.

witnessing except through men willing to be used by the Holy Spirit. See Acts 2:4; Eph. 6:19.

When such testimony was given, men were held accountable, whether the testimony was by word or work, v. 22-24, Heb. 2:4. The disciples were thus advised of three distinct relationships in this section we call ch. 15:

- v. 4—a personal relationship to Christ
- v. 12—a personal relationship to each other
- v. 27—a personal relationship to the world.

16:1 made it clear to the listening men that Jesus cared enough for them to prevent their apostasy, though the sin of others directed against them could not be prevented. Certainly the soon-to-come religious persecution challenged their loyalty to Christ. The worst persecution of all is that of religious people upon other people. Much of the trouble in countries in and around India today is a result of religious differences. Hence "are you big enough" was the problem the disciples would face in the future—big enough to believe that faith could help them keep contact with Christ, Who would be able in every circumstance to lead them unto victory.

The coming of the Holy Spirit as "counsel for the defence" into the lives of these men would mean that the truth about Christ would be presented to the world. A partial list of what the Holy Spirit was to do through and for them is as follows:

1. be with them forever
2. teach them all things
3. bring to their remembrance all Christ had said to them
4. bear witness of Christ
5. convict the world of sin, righteousness, judgment
6. guide them into all truth
7. speak as He heard
8. reveal future events

9. glorify Christ by sharing with them what was Christ's (which also belonged to God, John 12:44-50).

His work then was that of correcting and convincing men in regard to Christ. His was not to glorify Himself, but Christ, much as the harmony supports the melody. Perhaps you would profit by comparing the people at Calvary with the people at Pentecost in relationship to the work of the Holy Spirit.

In thinking about the three items in vv. 8-11, compare the sermons in Acts 2:22ff. and 24:24ff.

16:16-24 presented the men with a future to be marked by sorrow followed by joy. How vivid the colors would become against Gethsemane and the blackness of Golgotha! But Acts 4:29-31 and 5:41-42 follow hard upon these verses—and bear testimony of faith seen in these men that was greater than persecution, or people or anything else.

16:28 sums up the whole life of Jesus: 1) His entrance into the stream of humanity, and 2) His departure back to His rightful place with God: humanity sandwiched between deity. And because these facts were true, the thoughts expressed in vv. 31-33 reminded the disciples that the world at its very worst could never win! Certainly the peace that Jesus wanted them to have through Him was a state of mind regardless of the external circumstances—seen in the knowledge that they shared a right relationship with Him Who had the whole world in His hands!

The texts found in Math. 26:30-35; Mark 14:26-31; and Luke 22:31-38 fit in someplace before the scenes in the Garden, perhaps after the prayer in John 17, or maybe before it, since in John's order of events, the prayer is the next event succeeding the discussion in ch. 13-16, as he leaves out the events of our texts. The parallel texts of Matt. 26:36 and Mark 14:32 place the above discussion on

FINAL WEEK

Mt. Olivet and preceding entry into the garden of Gethsemane.

Though Peter is the main character presented for our consideration, it is well to point out that 1) all the disciples vowed they would not "be skandalized" (caused to stumble, or fall away—to sin, as in Matt. 5:29-30; Luke 17:1) because of the events to follow, and 2) all vowed they would die before they would deny Christ. All made the same mistakes, which cause the downfall of many Christians. They all contradicted the Lord, asserted they were better than others, and relied on themselves. All fell—let everyone who stands beware lest he fall! But Jesus had foreseen just such denials and had predicted through Zechariah the prophet, 13:7, that the shepherd would be smitten, with the sheep consequently scattered. May we learn that it is not wrong to be determined, but it is tantamount to failure to trust in that determination! Well did Solomon write, "Pride precedes destruction, and an arrogant spirit before a fall," 16:18.

Yet they were loyal, and Jesus knew that. Hence the prayer for Peter, since Satan had particularly asked (how did Jesus know this?) for Him. As Jesus pointed out, they had never lacked anything, nor would they, if they remained faithful to His will. Certainly it is heartening to realize that faith will cause us to repent and continue with the Lord, v. 32.

The remark in Matthew, v. 32, and Mark, v. 28, has several important points: 1) Jesus would be raised up (implying His death and burial) and 2) He would precede them into Galilee (implying that they would still be His disciples, and that a meeting in Galilee would take place with Him there after the "raising up"). It is important to remember this in the study of John 21. That chapter is often used to point out the fact that Peter, John and five others lost their faith in Christ and returned to the fishing

business. It makes a good sermon some think, but such are not the actual facts in the case. The men were there because they were told to go (Matt. 28:7, 10; Mark 16:7) and when they arrived, Jesus was there as He had prophesied. Their problem was that of unbelief in any resurrection of Jesus, Jn. 20:9, which unbelief was finally removed. Faith then issued in obedience, and the men went to Galilee as commanded.

The reader will need to compare the texts of Matthew, v. 34; Mark v. 30 and Luke v. 34 for the total statement Jesus made to Peter about his denials and the crowing of the rooster. Note also the fact that the disciples were armed with two short swords, somewhat akin to daggers. They apparently understood Jesus to say they should be prepared, Luke v. 36, for violence, and took the reference to the fact that He would be reckoned with the transgressors as indicative that a fight would result soon. The command to sell an outer garment (more costly and more valuable than the inner garment) to purchase a sword gave some impetus to such a response. Whether Jesus intended for them to understand Him in such a way is problematical in view of Matt. 26:52.

The prayer of John 17:1-26 has been the basis for sermons and devotional thoughts almost without number, and rightfully so. The simple but profound heart cry of Jesus to His Father is hardly matched by any other text. Without question, it is the real "Lord's prayer."

Perhaps uttered somewhere between the upper room and Gethsemane, surely in the presence of the eleven disciples, Jesus prayed about Himself, vv. 1-5; about the eleven, vv. 6-19; and about the church, vv. 20-26, all in relationship to God through Himself, with the end in view: eternity together!

The total impact of the prayer is one of success, achievement, work done, God's will accomplished in His life, in

FINAL WEEK

the lives of the men listening, and in the lives of those who would believe on Christ through their message.

Jesus implies that many counterfeit "gods" existed, but the only *true* God, the heavenly Father, was known through His Son Jesus Christ. The quality of life known as "eternal life" was only shared by people who habitually kept Him in their knowledge, v. 3. Those who wish to glorify God should consider v. 4—it is done through accomplishing God's will. Jesus spoke about Himself—the final act of submission was considered accomplished (in what perspective should we view the prayer in Gethsemane as we compare the request there with the statement here?) and the utterance from the cross in 19:30 expressed it for all to hear. A final unselfish petition was for the restoration of His former state, a state of glory (how many different shades of meaning do the eight occurrences in this chapter of this word have?) shared equally with God, and partially seen in such manifestations as mentioned in v. 2. See also ch. 1:1-18 etc. The closing verses will reiterate this same point, with the additional idea of the believers eternally "seeing" that glory, which encompassed a death on a cross. Thus the prayer was not selfish—it exhibited the fact His earthly life was only meaningful in relationship to God, Who was known only through His Son, Math. 11:25-27.

The thoughts expressed audibly turned to his listeners, who surely must have remembered these moments with appreciation. Their Master had spoken about His own life, one of total committment to and accomplishment of God's will. Now He will ask the priviledge for them of repeating the same thing, and set Himself apart from all else that total submission might be given to the Father's will, v. 19, and accomplished through the sending of them unto a world, of which they must not be a part, but in which they must share.

God had a personal interest in these men. He had chosen them, and given them to Christ for the work of ministry, v. 9-10. God had been declared to them, v. 6, they had been given His message, v. 8, and, having received it, v. 7, 8, became persuaded that the message was true. The same plan of operation was to be followed by each of them—they were to proclaim God's word, the truth, to any and all. Those willing to receive and believe it would become a part of the great eternal kingdom.

Judas would teach us that the knowledge of God rejected in one's life causes rejection by God of one's life. He deliberately chose to go his own way, all that Jesus could do notwithstanding. Others did and do follow in His train despite the gifts and grace of God. God knew he would, and predicted it, even as He knows others will. But His sovereign decree of free choice for each and every man is not less wonderful or merciful because some will not to believe in Him through Christ.

God has created each of us with a destiny—that of loyally serving His will, whether we perfectly keep it or not. This we were created to do—we may be the means of bringing glory to Christ or not, as we will. If we trust Him to keep us from the world which hates us, verse 14, (15:18) and the evil one, verse 15, we can do exactly that, being kept by God's power through faith, I Peter 1:5.

Verses 11-19 predicted at least one thing: a lump of leaven that would change the world around it. That leaven was to be as Christ was, verse 16, and as the Father was ("holy"), even if the surroundings were not conducive for easily influencing others. Adherence to the only reality in this life, God's word, was to be the key to victory—the Master had so lived, and promised that what had been His could be theirs (and ours): victory! How utterly sad that some chose to lose rather than win, to bet their life on a lie, and suffer eternal loss, reaping what was sown,

FINAL WEEK

Galatians 6:7-8. (The same term used to describe Judas is used to describe the man of sin, II Thessalonians 2:3-6.)

The expression "these things" fell from the lips of Jesus eight different times in chapters 13-17. In later years the disciples remembered what Jesus had said, and took heart because of it, John 2:22.

The prayer for the eleven petitioned God that their witness might be to the world, not of it. Those who had heard the distinctive news from heaven became the subject of intercession. Christ did not expect defeat for these "hearers" (Isaiah 55:10-11) but success. The unity of the ministry, in which all were sent by God, both Himself and His chosen men, the oneness of their message, and harmony of purpose assured the results of believing men and women.

But the petition was for believers in the special way that each believer would sustain such a deep relationship to the message heard that the same type of oneness as existed with the Christ and God would exist between those believers. The result would be a continual persuasion among those in the world that Christ had been sent by God.

A last unselfish request: in His earthly life Jesus had both glorified God, and had also manifested His glory for all to see, John 1:14. Now the prayer is for those who will to believe that they might have the privilege to behold His glory forever. In the years to come, some would trade their birthright for a bowl of pottage, but others would look for a city whose builder and maker was God, abhorring the transient pleasures of sin and choosing rather to suffer with Christ. To these, God's four-square city in the land of endless day would be given. Love, peace, glory, and the fellowship of redeemed spirits made perfect (Hebrews 12:23), the joy of God Himself—good measure, pressed down and shaken together, yea, the life runs over! Thus the prayer ends as it began: with eternal things—the only reality in life.

(18) "The spirit is willing—it's the flesh that is weak!" Gethsemane, a small garden on Mt. Olivet, has often been the source of consolation for believers. The prayer of Christ reflects a very real human problem, yet it surely points to the only acceptable solution. No part of life is free from the subtle desires of the flesh in which we live. So often the "outer man" wins, and even when we do not wish it so. Jesus had to learn obedience even at the cost of self, but totally gave self for the only lasting good—that of God's will. The would-be disciple will not be spared because the same trials will be a reality in any life. The human part of us always wants the apparently easier way, will settle for less than full surrender. But God's way is best, and Jesus was willing, not for Himself, but every soul, sinful, degraded, devilish—yet worth the life of Christ Himself.

Matthew 26:36-46; Mark 14:32-42 and Luke 22:38-46 give the agony and struggle of Jesus in the garden of the "oil-press" (Gethsemane's meaning). The eleven placed as Jesus wished, He began to ask about God's will. The humanity of our Savior was not less real because He was deity. A cross at the end of sham trials and unjust beatings was not less horrible for God than anyone else. Why should we think it unworthy of Jesus to present an example to be followed as long as time shall last? What better place or way to reveal how to deal with the part of us which revolts at any thought of sacrifice, even if it be for high and holy causes? Discipleship is really that only when the issues are squarely faced, whatever they be. No wonder that Jesus was displeased with the disciples, even if they were tired, and sorrowful. He did not request their prayers for Him—each needed to bear their own burdens. Life is rarely without deep, sorrowful distress, or even discomfort or bewilderment. Jesus shared all of these emotional states in the garden. "Your will be done" was His unwavering

FINAL WEEK

response! So He had taught His disciples to pray, Matthew 6:10. And this in the face of the fact that a friend was on his way with soldiers to betray and arrest Him, for the clock of life had struck the "hour." Why did He go to a garden known to Judas (since He often went there, Luke 22:39; Jn. 18:2)? Why drink the cup of appointment, Matt. 20:22; Jn. 18:11? He loved you, and me.

The gospel writers present four accounts of the arrest of Jesus. Matt. 26:47-56; Mark 14:43-52; Luke 22:47-53 and John 18:1-11 reveal that Jesus was ever in control of the situation in life, whatever it might be. And He promised to do exactly as good for every one who would entrust their life to Him.

Men in years gone by have wrestled with the text at hand, not that any doctrine depends upon the settlement of the several problems in it, but rather to perceive accurately just what was said and/or happened. One of the problems is in the translation of what Jesus said to Judas, Matt. v. 50. The Greek text will permit several renderings, partially because it seems to be abbreviated. Sometimes intimate acquaintances so understand each other that abbreviated discourse occurs. Even our "yes" and "no" are abbreviated, symbolizing more complete answers. Whether this is the case or not, the following among others have been suggested: 1) "Friend (or comrade), do what you came for" or 2) "Friend, is this what you came for?" or 3) "Friend, what kind of work you came for!" Some help might be had if one could decide whether Judas kissed Jesus before anything was said, or if Jesus' statement followed the kiss, which kiss was preceded by the statement in Mark v. 48. If this last is the case, then proposed suggestions 1) and 3) are more likely. We can not even be sure what sort of inflection Jesus used (which often indicates what is meant) even if we could settle the translation otherwise.

Another problem is to decide just how the synoptics are to be fitted into John's account, assuming, as we do, that all accounts are true. Perhaps the solution is to assume that the traitor preceded the crowd enough for the exchange between himself and Jesus to take place before Jesus spoke to the crowd, or between v. 3 and v. 4 of John's account.

A third interesting problem is found in Luke, v. 51. Again the problem is of understanding, which determines the translation. The context does not indicate to whom the statement is directed, the apostles, the crowd, etc. Is Jesus to be understood as asking for permission to heal Malchus? Or that Peter's act might be forgiven since He was going to replace the ear? Or a statement to the apostles in regard to His arrest by the men, without reference to the ear, forbidding the apostles to intervene further in the proceedings?

Several things are more certain: Jesus loved His men, and provided for them to the very last; also that the men, with only two short swords with which to fight a large group, including as many as six hundred soldiers (the Greek word is "cohort," with a varying number of soldiers in it), were not cowards. But the remark about perishing by the sword, and healing the ear of Malchus may have so bewildered the men that they could no longer keep their courage to stay.

Certainly the remarks Jesus addressed to the rulers cut to the quick. Jesus remonstrated with them that they were acting like he was a highwayman (the same word is in Luke 10:30, and describes Barabbas, Jn. 18:40).

The determination of Jesus to drink the cup given Him by God was plainly evident when Jesus refused to have the support of seventy-two thousand angels, Matt. v. 53, Jn. v. 11. Certainly the principle stated in John 10:35 about God's expressed will is beautifully fulfilled in Jesus, even as He points out that which it demanded of Him,

Matt. v. 54, and then did it, Jn. 19:30. But then His entire life was sacrificially given in this way from the very beginning, Heb. 10:7.

The power of darkness seemed to have won the day, as Jesus, His disciples escaping in a moonlit garden, was led away to begin the trials. The unnamed man (some suggest John Mark) who fled, leaving his outer garment in the hand of some would-be captors, also ran. Truly, Jesus' words in John 16:32 came alive as darkness enveloped the departing giver of light. But a cross would be followed by a crown, Acts 2:36, and death defeated forever because the Son perfectly resigned His life for others, Jn. 12:24ff., and God was glorified in ". . . My Son, Who is well-pleasing."

(19) The departing mob took Jesus to the household of the actual Jewish high priest, Annas, as John 18:12-18 indicates (as noted under the remarks on the beginning of John's ministry, Mt. 3; Mk. 1; Lk. 3, Caiaphas had been appointed by the Roman government as a replacement for his father-in-law, Annas). According to Jewish law, the high priest was appointed for life. Hence, the Jews still recognized Annas, if not as high priest, as the power behind him. So the trials began.

The trials might be considered this way: John's account informs us about the trial before Annas, which trial could be labeled prejudgment. Matthew and Mark relate the trial before Caiaphas, where the real direction of things was set. Luke 22:66-71 chronicles in detail the final ratification before the hastily assembled Sanhedrin, which marked the send-off to Pilate's judgment hall. (See also Matt. 27:1, 2; Mark 15:1)

The departing crowd did not leave by themselves, for two disciples of Jesus followed them. John apparently knew someone in the high priest's household, as he was able

to enter himself, and also get Peter in, Jn. v. 16. The late night air in early spring was "coolish," and while the important business was going on before Annas, Peter joined the crowd around the charcoal fire in the courtyard. Seemingly the courtyard was below (Mark 14:66) the living quarters of Annas, or at least provided access (Matt. 26:69) to what was going on before Annas. Many sermons have used the idea about Peter following afar off, standing and then sitting as being an analogy of the way a person denies Jesus. This may be a good thought but the actual fact is that Peter was much closer to Jesus around the fire than perhaps any time after the arrest in the garden. He went to see the end, Matt. v. 58, and was close enough to see Jesus look at him, Lk. 14:61, after the crowing of the rooster. Peter had the right idea, in spite of the apparent failure in the garden. Jesus knew that the devil would sift Peter, like a thresher, but the Lord also knew that Peter was not chaff!

The gospel accounts are not too plain in regard to the location of the places of trials before Annas and before Caiaphas, whether they were in adjacent houses, etc. John's account seems to locate the denials of Peter around both trials, that of Annas and Caiaphas, but the synoptics place the denials only in the trial before Caiaphas. John's account records a denial by Peter to the maid when Peter entered the courtyard, 18:17, which perhaps is the same one as noted by Matt. v. 60-70, and Mark v. 67-68. Maybe the maid was the kinsman of Malchus, Jn. 18:26. Certainly the attempts of Peter to deny any relationship to Jesus were hopeless, for every time he attempted to speak, his accent shouted to all within earshot that he was a Galilean and highly suspect. Finally in desperation, he invoked a curse from God upon himself, and called God to witness to the truth of his assertion. Alas, Jesus knew Peter too well, and the crow of a rooster "jarred" the proper neurons

in Peter's brain together, and he, remembering Jesus' predictions, went out and wept bitterly.

An observation or two about Peter's denials. One thing to be noted is that the accounts do not present them in a form easily harmonized. It is even difficult to decide if we can locate them all in the same place, since a period of time elapsed, Mark 15:59, during the denials. The only sure things are contained in the prediction of Jesus: three denials before rooster crows two times. A second observation is this: the Revised Standard version correctly translates the action of Peter when he attempted to enforce his claim about himself to Jesus. It may sound good from the pulpit to depict Peter as a typical sailor (or fisherman): cursing and swearing. It is poor exegesis however, besides being a false insinuation upon sailors and/or fisherman, either of whom do not necessarily use bad language. The action of Peter was to call God as his witness to the fact that his denial about being Jesus' disciple was truth, and for God to place a curse upon him if he was lying. See Matt. 23:16ff. for other occasions of men swearing to a statement and invoking a curse upon themselves. Matt. 5:37-38 and James 5:12 refer to this practice, and instruct the disciple to be such that the necessity of proving his credibility will not be needed, unless the law requires it. The only reason for oaths in court is because men are not credible, not honest, but deceitful.

The trial before Annas was clearly a farce. Jesus had said nothing different in secret than what He taught openly everywhere. No pretense at a defense for the accused was even made. Having accomplished nothing except perhaps a gain of time that the men of the Sanhedrin might be assembled, Jesus was sent to Caiaphas.

Matt. 26:57-68 and Mark 14:53-65 recall for us the trial before Caiaphas. It is interesting that Jesus was condemned only on His own testimony, as all other witnesses

could not agree (though some recalled His statements from three years earlier, Jn. 2) among themselves. When Caiaphas asked Jesus if He were the Son of God, Matt. v. 63, Jesus affirmed that He was, and was promptly accused of blasphemy and declared worthy of death. Some commentators, past and present, have gone into print with the affirmation that Jesus never claimed to be the Son of God, not even at this trial. The action of Caiaphas flatly denies their theory. He understood Jesus to respond affirmatively to the question (as did the council later) and upon that response Jesus was condemned. That ought to be plain enough for all to see.

Jesus not only revealed His relationship to the Messiah so long prophesied, but also declared events to come as concerning Himself. The future would reveal a great reversal of positions, and Jesus would become judge, Caiaphas and the Sanhedrin the ones on trial. Perhaps one would wonder why Jesus responded under oath to testify against Himself (which was contrary to Jewish jurisprudence) before Caiaphas and the Sanhedrin. But the answer to such wonder would be that Jesus never denied the truth about Himself, even if circumstances were adverse. Could His disciples but faithfully mimic that example!

Again the value of parallel accounts is seen, as we read Matt. v. 67-68, and then Mark v. 65. Note also that though the penalty for blasphemy was death, Lev. 24:15-16, the Jewish council did not have the power to carry it out. Hence, please note the charge leveled upon Jesus here in the courtroom of Caiaphas, and then read the text of Luke 27:2. Consistency is conspicuous by its absence, eh?

Passing by the accounts in Matthew and Mark and Luke concerning Peter, as the morning dawns we follow Jesus into the presence of the Sanhedrin, and an instant replay of the trial before Caiaphas, the same question/response occurring (Matt. 27:1-2; Mark 15:1; Luke 22: 66-

23:1). The only pressing need remaining: a sentence from the Roman governor to end the life of Jesus. So off to a sleepy Roman governor and a remarkable description of both Jewish and Roman officials practicing situation ethics!

Matthew intersperses the tragic figure of Judas into the trial events, and how pitiable is the sight of this man. Whether he had ever imagined the betrayal would go as far as it did is unknown to us, but Judas could not live with his conscience as the end of the trials became apparent.

Day having arrived, he took the now-hated money and traveled some unknown road to the temple. Herein were the temple priests engaged in the routine business of a feast day, soon to be immortalized by the sight of a remorseful man and the sound of a sack of money cast into their very midst.

Maybe the action of Judas is to be adored by all, but the remark of the man in Matt. v. 4b is surely one ne'er to be forgotten. One's sin is one's own responsibility, always and ever. More truthful words have never been spoken! Granted that the men who said it were also guilty, though disclaiming such, the truth yet remains: all must answer to God for their own sin!

It is worth remarking that the men were so indifferent to the fact that a man was being killed, yet so technical about the money given to take that life. Note Jesus' word in Matt. 23:23. Another interesting item is that the versions in general have so translated the text that Judas is portrayed as repenting. Such is not the actual case, as he did not change his life and start doing God's will again. Peter is the example of repentance, not Judas. The Greek term is only the description of the state of mind that leads to repentance. Repentance is a decision of the will, not an emotional feeling.

Comparing this text with that of Acts 1:15ff., Judas left the temple area and, unwilling to repent so that God

might use him henceforth, went to a place near the city and took his life by hanging himself. The rope in some way failed to hold him until someone found him. He subsequently fell, and the force of the fall was so great (or perhaps the object upon which he fell of such nature) that his body was burst open. The place wherein he fell received one of its names from this happening. The field received a second reason for its name when the chief priests decided to take the money Judas returned and purchase a field in which strangers could be buried when they died. The way in which the same field was both the place where Judas fell and also the place purchased is not stated, however. The fact of his betrayal together with the purchase price were foreknown, however, by God, and as He had said five hundred years earlier (Zech. 11:13) Judas and his money figured in both the betrayal of Israel's shepherd and the purchase of a field. If God would reveal your future five hundred years from now, what would He write?

Judas confessed to the fact that he had sinned, v. 4. Some of the most famous, or infamous men in the Bible made the same confession, as Pharaoh Ex. 9:27; Balaam Num. 22:34; Aachen Josh. 7:20; Saul I Sam. 15:24, 30; David II Sam. 12:13; 24:10; Ps. 51:4; Shimei II Sam. 19:20; Nehemiah Neh. 1:6; Judas Matt. 22:4; and the younger son in Luke 15:18. Yet the Scriptures can be searched in vain to find those words falling from the lips of Jesus!

The accounts have presented us with a sequence of events as follows: 1) arrest in the garden, 2) appearance before Annas, 3) before Caiaphas, 4) before the Sanhedrin. Now we leave the Jewish phase of the trial and the accounts present the following: 5) appearance before Pilate, 6) before Herod Antipas 7) before Pilate (final condemnation), then the beating and crucifixion.

Matt. 27:11-14; Mark 15:2-5; Luke 23:2-5 detail the first phase of the Roman trials in the appearance before

Pilate. Notice the charges are all political in nature (which were in fact true of the men making the charges) whereas the charges in the Jewish phase were religious in nature. We call such activity situation ethics!

Jesus again affirmed His identity to Pilate, while refusing to argue with the trumped-up charges placed against Him. A confession of identity can be several things, especially as it is expressed by our lives concerning Jesus. We must believe that Jesus of Nazareth is the Christ, the Son of God. When we pledge ourselves to obedience under His lordship, we have done so because, like Peter, the revealed information from God has convinced us. Too, a lifetime of daily confession is a matter of the will, and asserts that we are enrolled in the school of one Jesus. Such activity as we have in mind is personal, as it is never sufficient for us that others obey Jesus. We as individuals must do such for ourselves. It is our expressed oath of allegiance through life and lips that is needed to purchase our redemption. Thus the truth expressed by Jesus to the Sanhedrin and to Pilate about Himself is all that is essential in our salvation. Acceptance (in the total meaning of this word) of that truth throughout our earthly life is obligatory—nothing else will suffice. Jesus died with that truth the cause of death. We too must daily die to self and continually live to Him in the light of the same truth.

In passing we notice the reference to multitudes in Luke v. 4. We doubt that the same people are involved in this group that were in Sunday's crowd at the triumphal entry. One reason is that the Jewish leaders were the only ones who would have known about the arrest plans, and doubtless did not broadcast the fact. After the arrest, though the disciples fled, it is problematical as to whether the disciples would try arousing people to prevent any further events to befall Jesus. They would not even know where He had been taken for a while. If they arrived at

Pilate's judgment seat with people "pro-Jesus", no such reactions as are recorded would have taken place. We assume that the crowd present at sunrise were people "pro" Rome, anti-Jesus, informed of the proceedings by the Jewish hierarchy, and gathered for the express purpose of bringing an end to the trouble maker from Galilee, Jesus by name,

"A tempestuous fellow!" Thus did the people describe Jesus to Pilate, as they reacted to his first attempt to release Jesus. The word translated "stirreth up" in K.J. is the same one used to describe the action of the chief priests in Mk. 15:11, and the root word is found in such passages as Mt. 8:24 describing the storm on the Sea of Galilee.

When Pilate learned the Jesus was of Galilee, he sent him to Herod Antipas who was over that part of Palestine. Arriving at Herod's court room only accomplished one basic thing: the cementing of a friendship between Herod and Pilate. Jesus refused to be used by anyone and Herod was no exception. Being made a spectacle and a joke, not taken seriously, contemptuously treated: these were the things Jesus experienced in Herod's presence. Which do you think hurt worst: the mockery by Herod or the beating from Pilate? No marvel that He refused to satisfy this "fox."

Arranging the texts concerning the events from the point of the arrest is somewhat difficult. Each account does not mention some events the other three do. John's account does not apparently mention the first appearance before Pilate, and the succeeding one before Herod as illustrative of this problem. Skipping these events, John takes us from the courtroom of Caiaphas to Pilate's courtroom for the second appearance of Jesus before him. The reader should remember that the accounts can omit events, or add to accounts of events and yet not deny the truthfulness of other accounts, as this instance. The only time

FINAL WEEK

a conflict would be evident is if one account denied what another affirmed.

We assume the text beginning at John 18:28 chronicles the return of Jesus to Pilate's hall from Herod. Perhaps a comment about the Jews, the Passover, and potential defilement. As pointed out on the discussion of 72 (1, 4) the word Passover is used to mean both the day and the week. Since it is early morning, the Passover meal has been eaten (as did Jesus and His disciples) by all Jews, including these men. Hence the defilement in question was in relationship to the ensuing day's activities. Any defilement as herein contemplated could be removed by evening anyway. (We can but wonder which was considered greater: a defilement ceremonially or morally?) The only real item in the coming day's activity which they would be unable to keep was a festive offering called the "Chagigah," a later addition to the seven day feast.

A word concerning Pilate is in order. He was appointed procurator in 26 A.D. He is little spoken of outside the gospel accounts, from which we glean most of our information concerning him. He was knowledgeable concerning Jesus and the Jewish hierarchy, enough to quickly see the charges were untrue and Caesar had nothing to fear from Jesus. He knew jealousy was the cause of the whole thing. However, the politician in him was too great, and he capitulated to the desire to keep down trouble for himself by sacrificing Jesus, even though he knew no reason existed for the crucifixion. Note that he came out to the crowd, since they would not come into his palace.

Pilate attempted to bluff his way out of the sticky problem, tried to shove Jesus off on Herod, proposed a deal for Barabbas, and presented the remains of a whipped man to a obstreperous crowd, yea, did everything but what he should have done: released Jesus. He might have thought that he could wash his hands of the affair, but life is not

so ordered, as pointed out in II Cor. 5:10. Jesus implies as much in the remark in Jn. 19:11. Though others (Caia-phas? Judas?) had sin for their part in Jesus' betrayal, Pilate also did.

The text of Jn. 18:28-38 reveals that Pilate was probably unaware of the desired aim of the Jews: the death of Jesus. At least Pilate is reminded by the Jews that they can not *legally* (note Stephen's death in Acts 7; also the attempt to kill Paul in Acts 22, all in a mad fury) execute Jesus. He asks for some reason to continue the trials, since he has declared Jesus innocent, as has Herod. The response (v. 30) might be translated "If you know what is good for you, stop asking questions and grant our request." The Jews had caused him some trouble with Caesar in previous years, so this was no idle threat.

The exchange of words in vv. 33-38 present both truths and questions. Certainly one of the last is Pilate's expression in v. 38. The tone of his voice, his facial expression, the timing; none are known by us. Hence we are unable to settle upon any sure interpretation of his words.

The statement of Jesus in v. 36b is capable of various meanings. That the church is not a physical entity is known from other scriptures. That the church is not a product of man, not conducted as men wish, are also facts. That no one could "use" it and remain innocent is likewise true. That Jesus did not intend that the church exist or spread by such devious principles as were in evidence at the trial going on is patently (plainly) true. His whole life was lived that the world might know reality (=truth) was and is an actuality, and the divine purpose for His life included adherence to better principles than Pilate was then practicing. Had Pilate considered the issues honestly, truth would have been observed as standing before him embodied in the person of Jesus, ultimately his judge!

FINAL WEEK

The particular arrangement of texts we are following presents the text in Luke 23:13-16 for consideration. When Pilate responded to the chief priests and company, he rejected every one of the alleged charges against Jesus. As we before suggested, this was doubtless not the first time Pilate had heard of Jesus. The charges were rather transparently false, and Pilate was certainly astute enough to discern the fact. Had he the moral fiber to match his mental acuity, the outcome would have been different. By the way, have you tried to count up the times Pilate said Jesus was innocent?

If you are interested in words, the Greek term translated "chastise" is the word used in Acts 22:3 in reference to Paul's education, in Titus 2:12 as to what "grace" is to do for us, and in Heb. 12:6, 9, 10, etc., back of the idea of discipline or its synonyms.

Changing his tactics, Pilate tried to release Jesus by presenting Him as the best of a bargain. He reckoned amiss. The depraved Jewish leaders could already "taste" blood and they did not intend to be thwarted. Barabbas, guilty of murder, robbery and inciting a revolt against Rome (remember the charges against Jesus?), was to see the light of freedom and the Jewish hierarchy to a man for it! Matthew v. 20 points up the fact that they persuaded (Mark "stirred up") the people to ask for Barabbas. Despite a warning from his wife, and oft-repeated (but unanswered) requests for any evil Jesus had done, Pilate's self-preservation was too strong to permit aught but satisfaction for the crowd. Pharaoh was not the only one whom God tried, nor was Peter the only one whom Satan sifted—Pilate, like Belshazzar, had been tried, and God found him wanting!

One final try to shake the murderous Jewish minds: present to them the grisly spectacle of a man flogged. Pilate struck out. He capitulated to their envy and the

man in whom he could find no crime was at last on the way of the cross.

Such is the gist of the Gospel portrait of the trials—truth went out the window, and sin materialized on every hand. Truth attempted to “out” at times, but perverse men exchanged it for a lie, and another reason for Jesus’ death came into existence. Pilate was not uninformed about God, nor aware of truth. He simply refused to be as much for right as the Jewish leaders were for wrong. All that is needed for wrong to triumph is for the right to be crucified.

The texts of Matthew 27:24-31; Mark 15:16-20 and John 19:12-16 relate the final moments of choice for Pilate, the chastisement of Christ, and the scuffling of sandaled feet on stone streets as the way of sorrows takes shape for a Roman centurion, his guard of soldiers and a victim of love named Jesus.

Perhaps the remark of the crowd in Matt. v. 25 is worthy of attention. How truthful was the remark. Peter said as much in Acts 2. This attitude was a characteristic too often a part of the Jewish nation at any given time in their history. It is little wonder that God would make the new covenant universal in nature, with the condition of trust alone demanded of those a part of that covenant, Acts 10:34-35.

“Take Him away—now!” Thus at about sunrise, Friday Nisan 14, the day of Preparation, Jesus walked out of a place of evil to a place of justice, the cross. At the hands of men, evil had become a reality. At the cross, truth and justice would be presented as eternal absolutes. God spoke for all time as He died on a cross of human making that He kept His word. The law that demanded death for sin would be honored. Righteousness was neither forgotten nor dismissed, even if it seemed so at times. God, though snubbed by people given over to the devil, yet gave Him-

FINAL WEEK

self for those people. Love, honor, duty: forever silhouetted against a background of people who disclaimed any king but Caesar. The message to be proclaimed by all followers of the Christ: In Him you may escape from the snare of the devil, who captured you to do his will, II Tim. 2:24-26.

"Do you weep for Me? I have wept over you. And you will weep because you did not weep sooner!" The accounts of Matthew 27:32; Mark 15:21 and Luke 23:26-31 carry us along the still sleepy-eyed streets of the city of peace toward destiny outside its walls (Heb. 13:13). Gathering onlookers expressed various feelings as Jesus passed them. He was innocent, a green tree, and yet punishment had become His. Would not a guilty nation burst into flame even as a powder-dry tree? Yes, it would and did. That which would normally be a reproach (childlessness, Lk. 1:5ff.) then would be a blessing. Every one would bear his own cross during that time of justly deserved punishment, because they had refused to accept Jesus.

(20) A small matter of interest: did the lack of food and drink, emotional exhaustion, various buffetings by inconsiderate men, loss of blood and strength through a whipping, so incapacitate Jesus that Simon was forced to carry Jesus' cross? This fact that Simon was carrying Jesus' cross is often missed by artists (and preachers too) who attempt to portray the procession to the place of crucifixion. An incidental mention of Simon as being the father of two sons perhaps indicated that the first readers knew a Simon, or knew his sons. Paul mentions a Rufus in Romans 16:13.

God keeps His Word! "The soul that sins, it shall die . . . but the grace of God appeared!" The cross depicts the reality of sin, which is a word describing the transgression of God's will by moral beings, ie., humans. The cross likewise teaches the extent of God's love for those same undeserving moral beings as He personally became

the substitute for all. The perfect understanding of what the cross means is perhaps beyond anyone's ability, but we can certainly grasp what we have just said. Consider the facts that 1) all (have) failed and 2) mercy by its very nature can not be demanded. Yet "in the fullness of time God sent forth His son . . ." (Gal. 4:4) that mercy could be extended.

The cross is the exact time and place where God took the place of every sinner, not only that His word might be kept, but also that His mercy could be available.

Perhaps the necessity of the sacrifice of Jesus can be understood better in the light of Hebrews 9:1-10:18. Though men in faith offered sacrifices God had decreed, yet two facts were evident: 1) such sacrifices could not make the offerer perfect, because 2) only the blood of Jesus actually atoned for sin. Do you see a new import to John 3:16?

In thinking about the cross, perhaps the following bits of information will be helpful. Jesus, Simon carrying His cross, was led by the Roman soldiers to some place outside the city, Heb. 13:13, though near it, John 19:20. John records that Jesus was crucified within a place containing a garden which contained Joseph's new tomb, 19:41-42. No text says that the place of crucifixion was on a hill, or even near one necessarily. The remarks of Matthew 27:33, found also in the other accounts, do not say the place of crucifixion was in the shape of a skull. It may well mean a place of skulls. The only name the Gospels give the place is a Hebrew name, Golgotha, which means the place of the skull. (The word Calvary is a Latin term carried over into English translation.) Isaiah, some seven hundred years earlier, had clearly drawn several aspects of the crucifixion, and one of those was in the statement that Jesus would be crucified with transgressors, 53:12. The

FINAL WEEK

gospels note that Jesus was crucified with two other men who were criminals, and His cross was between their crosses.

The method of crucifixion varied greatly from time to time, and we have only some statements in the Gospels, along with some inferences, to help us decide just how Jesus was crucified. The traditional shape of the cross is only an inference from the accounts. The text in Matt. 27:37 states that the inscription of Pilate was placed over Jesus' head which may indicate the traditional shape. The shape is really unimportant, however.

The text in Psalms 22:16 seems to imply that the soldiers used nails to place Jesus on the cross. Yet the text of John 19:36 makes the reader wonder how nails could be used and yet no bones be broken.

Perhaps it is of interest to the reader that crucifixion was not a Jewish mode of putting people to death (see Deut. 21:23; Gal. 3:13; I Cor. 1:23). Within the Roman Empire, no Roman citizen could be crucified, only slaves and criminals. The Jews hated the Romans, but no love was lost, because the Romans hated the Jews. See then how much the Jewish hierarchy hated Jesus to put Him to death in such a way, but do not overlook with what smug satisfaction Romans must have put the Jew's king on the cross (do you see why Pilate might have written what he did, and refused to remove it from over Jesus' head?) Does not God's love grow bigger in this light?

The procession having reached the place of death, the men went about the business of putting the three "criminals" on the crosses. The gospels (Matt. 27:33-38; Mark 15:22-27; Lk. 23:32-38; Jn. 19:17-25) record that a drink of wine, apparently with an additive of myrrh (does the word "gall" in Matthew describe the bitter taste of the mixture, or is it the same as the myrrh, or even a third element in the drink?). The drink refused by Jesus, the cross transfixed its victim in space, to keep him there until

the last labored gasp of air was drawn. Sometimes men lived for days before merciful death became a part of their earthly existence. Settling down to an indefinite length of watch, the soldiers were understandably devoid of any feelings in the matter since (one could hardly pity any Jew anyway) death was such a commonplace event in their life. We could understand, too, that one dare not get "involved" to the point that such things would keep one awake at night.

"Bring the dice!"—The harsh voice jerks the onlookers to attention as the division of the Jew's remaining items of clothing begins.

The garments of Jesus were being divided, but the seamless inner robe (the outer robe was worth more, but could apparently be made of several pieces of cloth, as well as in one piece, since the soldiers divided the outer garments) was not torn into pieces, but gambled for, Ps. 22:18 being fulfilled.

Pilate's inscription was not a necessary part of the crucifixion, so one wonders just why he went to the trouble to have it made and placed over the head of Jesus. Perhaps, as suggested above, it was out of spite, a way of making up for all the trouble the Jews had caused him. Yet we wonder just how much Pilate's remark of 18:38 is to be seen in this inscription and refusal to change or remove it.

The Gospel accounts record seven expressions by Jesus while on the cross. The hours between 9:00 and 12:00 (John 19:14, Roman time, is 6 a.m.) or the third unto the sixth hours as the Jews counted time are the hours within which three of these utterances occurred. These are, in probable order of occurrence.

1. Lk. 23:34 "Father, forgive them because they understand not what they are doing."

FINAL WEEK

2. Lk. 23:43 "Today, you shall be with Me in Paradise."
3. Jn. 19:26-27 "Woman, behold your son. (John) behold your mother."
During the time of darkness, and close to or at the 9th hour (3 p.m.), the expression found in Matt. 27:46 and Mk. 15:34:
4. "My God, My God, why have You forsaken Me?"
Then after the 9th hour, perhaps in rather quick succession,
5. Jn. 19:28 "I am thirsty."
6. Jn. 19:30 "It is finished."
7. Lk. 23:46 "Father, into Your hands I commend My spirit."

We then have a total of three separate utterances recorded by Luke, three separate utterances by John and the same one recorded by both Matthew and Mark.

"Father, forgive them!" The loveliest and rarest jewel in any person is forgiveness. Humanity is approaching godlikeness when forgiveness is extended, especially if it is not deserved or requested. Jesus set a great challenge before us in this respect, and as well in the use of the word Father. In spite of the adverse circumstances, His total outlook on life as being in God's hands had not changed. And all of this despite the evil intent of the Jews, and contemptuous indifference of the Romans. However, we do well to consider that Jesus does not specifically identify who "them" is. He may have meant the Jewish leaders, the Jewish people, and or the Roman "establishment." All were in need of forgiveness from some points of view, whether willfully ignorant or otherwise.

Ignorance is not excusable, however, in the realm of responsible morality, even though it is more forgiveable. The men might not have known (understood) the griev-

iousness of their deeds, but they were still wrong. Peter underscores ignorance in Acts 2:36 and 3:17; Paul likewise in Acts 13:27; I Cor. 2:8 and I Tim. 1:13. Yet all were sinful anyway. They could have had the opportunity to know but rejected the opportunity. Sin was the result. Hence, intercession for guilty men has begun.

The texts of Matt. 27:39-44 and Mark 15:29-32 are always interesting, and much has been written on the groups around the cross. It does seem somewhat strange that one of the two thieves could see enough of God shining through Jesus to change his mind, while the rest could not. One of the taunts implies that if Jesus were really God's son, then a son's privilege should surely include escape from the cross. Too, the fact of the cross obviously (?) precluded the assertion by Jesus that He was the Messiah (Ref. Jn. 12:34). The men mocked Jesus with words, but also with action. The Greek word translated "mocked" in Matt. 27:41 implies acting somewhat as children do. Perhaps more of their character came through than they realized?? So, some like the Jews saved themselves only to lose. One, even Jesus, saved others at the expense of Himself. Which of these, think ye, made the wiser choice?

The intense hatred for Jesus by the Jewish leaders is amazing. They had so programmed themselves to accomplishing Jesus' death that nothing moved them. The Gospels recount the beginning of it in John 2, and a year later in John 5 and Matt. 12. Jesus' popularity grows and they snap at His heels all the second year of ministry and down into the third year. John 7-10 records their feelings. Another three months go by, and John 10:22ff. records how far they had progressed in hatred of Jesus. Despite His great power even to raising the dead, John 11 shows their planning and when Judas came with a way to accomplish it, they "rejoiced."

FINAL WEEK

Such is the way with hatred. Nothing known to man will cure it save love. It is a deadly poison in one's life, and the hurt it brings is beyond measure. Hatred divides friends and dries up the soul. It doubtless makes the devil shout for joy when Christians hate wrongly. But we can find a way to express hate that is scriptural! We can hate as Jesus commanded in Luke 14:25ff.; John 12:24-26; and evil of all kinds, Rom. 12:9; Jude v. 23; Rev. 2:6. Love and hatred are so strong that both must be channeled in the right ways or we will be consumed by them. Let us determine not to love or practice falsehood, but rather hate it, and to love righteousness and light, Psalms 26:5; John 3:18-21; I John 2:15-17; Rev. 22:14-15. We can be as God, hating divorce, Mal. 2:16; and lawlessness, Heb. 1:9. We know that some people will hate us as they did our Master, John 15:18—16:4. Let us make sure that it is with us as with Him: they hated Him *without cause*; Psalms 69:4.

Luke adds the information in 23:39-43 to the everlasting credit of one thief. Apparently he had earlier sided with the others in lashing out at anyone, especially Jesus. But for some unknown reason, he changed.

As we remarked under John 3, it is entirely possible he was one of the many who was immersed for the remission of sins during the ministry of either John or Jesus. We may have then a reason for his change from earlier hours on the cross. Hence he responded to the other thief who was speaking against (the Greek word is the word for blaspheme) Jesus as Luke records in v. 39. The man's question to Jesus about being the Messiah (Christ) expects a "yes" answer, but he like many others did not really comprehend the nature of the Messiah. The penitent thief reprimanded him, and asked Jesus to be remembered. Whether he meant before death or later we do not know, but Jesus probably gave him more than he expected.

"Today (there is little point in translating it any other way than with the idea that enjoyment of Paradise would become a reality on this very day) you will be with Me in Paradise." Such is but evidence of what the Christ of the Cross can do!

The quibble by some over the thief being saved without immersion is just that. As stated, the silence of the account proves nothing, and some evidence is available to at least show the possibility of a prior immersion. He is not the first one for whom Jesus forgave sins anyway. We doubt that anyone can be saved in the same way as the thief on the cross except the thief on the cross.

Paradise is a word of unknown quantity. It occurs here, in II Cor. 12:4 and Rev. 2:7; apparently always a description of the abode of the blessed. Whether it describes the same state in life as the state enjoyed by Lazarus and Abraham (Luke 16) is also unknown and unprovable. It may well indicate heaven. Consider the following Scriptures in the order presented with the thoughts in mind of 1) where Jesus is, and 2) where we are when out of the physical body (we call ourselves "dead"): Acts 2:33, and 7:55; then Phil. 1:23 with II Cor. 5:6-8.

The hours are passing and yet among the crowd was John and Mary, Jesus' mother, and other women of His followers. Even with the tremendous burden of the sins of the entire world upon Him, Jesus did not forget His mother. He was perfect, yet appreciative of the help of others. She may have little understood this unique Son of hers, but she cared about Him. "John" (this is now) your mother." Whether the expression directed to Mary was about John whom she should behold or Himself is debatable, but there was no mistaking the words for John.

Perhaps it will be worth the space and time to discuss the relationship of the various women John mentions in

FINAL WEEK

19:25-27, for it is from these accounts that we are able to distinguish the relationship of the Lord to James and John.

Matt. 27:56	Mary Magdalene	along with Mary the mother of James and Joseph,	and the mother of the sons of Zebedee
Mark 15:40	Mary Magdalene	and Mary the mother of James the Less and Joses	and Salome
John 19:25	His mother and Mary Magdalene	Mary the wife of Clopas	and His mother's sister

In McGarvey's *Four-fold Gospel*, page 225, he remarks as follows:

"Matthew and Mark each name three women, whence it is thought that Salome was the name of the mother of James and John. But the solution of the problem depends on our rendering of John xix. 25, which is translated thus: 'But there were standing by the cross of Jesus his mother, and his mother's sister, Mary the wife of Clopas, and Mary Magdalene.' Now, was Mary, the wife of Clopas, named and also additionally described as sister to our Lord's mother, or was it the unnamed Salome who was her sister? Does John mention three or four women? The best modern scholarship says that there were four women, and that therefore James and John, the sons of Zebedee, were cousins of our Lord. In support of this it is urged:

1. That it is unlikely that two sisters would bear the same name, a fact which, as Meyer says, is 'established by no instance.'

2. John gives two pairs of women, each pair coupled by an 'and.' The first pair is kindred to Jesus, and is unnamed and is paralleled by the other pair, which is not

kindred and of which the names are given. Hebrew writers often used such parallelism.

3. It accords with John's custom to withhold the names of himself and all his kindred, so that in his Gospel he nowhere gives his own, his mother's or his brother's name, nor does he even give the name of our Lord's mother, who was his aunt.

4. The relationship explains in part why Jesus, when dying, left the care of his mother to John. It was not an unnatural thing to impose such a burden upon a kinsman."

"Why?? (have you forsaken me)" The word hauntingly echoes down through the years of history to even us. But we really know the answer, do we not? Because God made Christ, Who knew no sin, to be sin for us, II Cor. 5:21. Our sins had separated us from God, Isa. 59:1-2, and His Son took our place, our sin, our sentence, Isa. 53:4ff., Ezek. 18:20. When Jesus became sin(ful), the effect of sin became a reality for every believer, if such believer would become crucified and buried with Jesus, Rom. 6:1ff., and Gal. 6:14; henceforth to live in Christ, John 10:10b; Eph. 2:1ff., Col. 3:4.

How Jesus can sympathize with us, Heb. 4:14-16! But can we measure His anguish? The cost of sin? God's love for sinners? Perhaps the reason for the expression at the end of the dark hours is to incite our thinking on questions like these! We can cherish Him for suffering desertion by God on our behalf even if we never satisfy our questioning mind.

The darkness is like other events surrounding the death of Jesus: a paradox, stated as fact but unexplained for cause. The moon was full, so no chance there for an eclipse. It is stated the entire world experienced darkness, but not why the sun was eclipsed. Some have suggested the darkness was for our benefit, a symbolic lesson

FINAL WEEK

on the effects of sin. Perhaps—but we can only speculate. The effect seemingly helped to create a change of mind in the Roman centurion. At least a change took place, and this was one of the things he “saw,” Matt. 27:54.

For those whose interest is in points of grammar, and/or word studies, the expression of the people as found in Mt. 27:49 is in the form of a future participle of purpose: “Let’s see if Elijah will come *for the purpose of saving Him.*”

The Greek word translated “forsaken” is a compound. The root word in compound form is found in such passages as Mt. 4:13; Lk. 5:28; 10:40; Acts 6:2; Rom. 9:29; II Cor. 4:9 and II Tim. 4:10. The desertion was real, whether we understand or not. Maybe we simply have not realized the penalty for sin. Yet, Jesus’ expression was “My” God. His faith in and allegiance to God were yet realities. (He could well have asked about others forsaking Him—Peter, James, etc., but He did not do so.) Jesus certainly uttered these words, but these words were not the last to fall from His lips!

The cross is a space-time event. History is composed of just such things: an event in space and time. The believer rests his hope on the reality of the sacrificial death of Jesus on a cross, or he rests it on nothing. The O.T. pointed to this time in type and prophecy.

The death, the burial, the resurrection—these form the basis for any and all we do. See the reasoning throughout ch. 15 of I Corinthians as an example of this idea, noting especially verse 58, “Therefore . . .” These events confirm the person of Jesus as the Son of God. As such, He has the authority for what He taught, Acts 17:30-31. We are not left to our own thinking or choice—He does our planning and choosing if we accept His authority—and that through the N.T.

The text of John 19:28-29 seemingly presents another evidence of the perfect fulfillment of prophecy. Jesus had before remarked in Jn. 10:35 that not one word of Scripture would fail to be accomplished. All was to be kept, Mt. 5:17-18. Whether or not we can decide if the natural thirst of Jesus, augmented by the bodily suffering of the preceding hours, prompted the remark, or whether He purposefully said this to keep His own Word (given hundreds of years earlier through His servants, the prophets) or both, we can feel keenly once again His humanity! The passages in Psalms 22:15 and 69:21 are probably the passages to which He refers, though there is no direct quote of any O.T. passage. We translate v. 28 as follows:

After this Jesus, knowing all was now completed, said (fulfilling Scripture) "I'm thirsty."

The parched lips and dry throat moistened, a cry of victory leaps out: Finished! The Greek form is in the perfect tense, indicative of a life that had never swerved from God's will, even for a moment. He had come to do God's will, perfectly, always. Heb. 10:7 reads, "Behold, I have come to do, O God, your will." The cross was always in His sight, Heb. 12:1-2, beginning with Luke 2:49; then Jn. 2:19; Mk. 10:45; Jn. 12:24. Now, with that purpose a reality, God could be both just and the justifier, Rom. 3:26. Christ was true to His Father's will unto the point of death, which is exactly what is expected of us, Rev. 2:10b. Thus we, like Paul, glory in Christ and Him crucified, I Cor. 1:18—2:5.

"Father, into Your hands I entrust My spirit." Jesus died with a winner's cry of victory and assurance on His lips. So had He spoken in Jn. 16:33 "Be of good courage, for I have overcome the world." Dare we follow aught but His steps?

The parallel accounts are rather interesting in this

FINAL WEEK

particular place. We present them in sequence according to R.S.V.:

Mt. 27:50 "Jesus cried again with a loud voice and yielded up his spirit."

Mk. 15:37 "Jesus uttered a loud cry, and breathed his last."

Lk. 23:46 "Jesus, crying with a loud voice, said, "Father into thy hands I commit my spirit!" And having said this he breathed his last."

Jn. 19:30b "he bowed his head and gave up his spirit."

These show that to the very last breath, Jesus had this earthly life under control. The flesh was made the servant of the spirit—and His life reflected this fact. I Peter 2:22, "He did no sin." In a greater way than we understand, He came, He saw, He conquered.

The Roman soldiers had doubtless witnessed many deaths, whether upon crosses or otherwise. But this life/death was not as the others had been. First, the demeanor of Jesus had been decidedly different than most if not all. Next, the darkness that occurred was unusual. Lastly, the moment of death brought an earthquake of enough magnitude that the ground trembled and rocks were broken into, with some graves being disturbed to the extent that some were opened.

The accounts of Mark 15:38-39 and Luke 23:47 are basically contained in Matt. 27:51-54. This last account shows two events that happened aside from the earthquake: 1) the veil between the Holy Place and the Holy of Holies was torn into two pieces, and 2) the resurrection of some people who had died, and their appearance to people in the city. Two questions left unanswered are these: Does the expression about the veil "from top to bottom" mean the tearing began at the top and went

to the bottom, or is it simply a way to emphasize that the rent was complete; and did the saints arise after the resurrection of Jesus, or did they appear in the city after the resurrection (what happened to these resurrected ones after their appearance?)?

The focus is now upon the centurion. He is described as having witnessed the events of Jesus' death, and 1) he praised (the Greek word means glorify) God, 2) and said, "Certainly this man was righteous." Mark's account records that he said, "Truly this man was the Son of God." Matthew's account has the group of soldiers expressing this thought.

A moment spent considering this man and what he said will be worthwhile. First consider the Greek word translated "certainly." It occurs in the following texts, as given in R.S.V., with the English word italicized which translates the Greek word in question.

Mark 11:32 "(the people) all held that John was a *real* prophet"

Luke 24:34 "who said, 'The Lord has risen *indeed*,'"

John 8:36 "you will be free *indeed*."

I Tim. 5:3 "Honor widows who are *real* widows."

Other texts to consider are I Cor. 14:25; Gal. 3:21; I Tim. 6:19. The man was rather definite about his deduction.

Now, the word translated by R.S.V. as "innocent" is the same word that occurs in the following texts, with the English word again italicized.

Mt. 1:19 "Joseph, being a *just* man."

Mt. 10:41 "he who receives a *righteous* man . . . *righteous* . . . *righteous* man's reward."

FINAL WEEK

Romans 1:17 "He who through faith is *righteous* shall live."

Heb. 12:23 "the spirits of *just* men made perfect."

He was rather specific about the character of Jesus also. That we do not know if he had been an observer of the trials before Pilate and Herod should be kept in mind.

The expression in Matthew and Mark is often deprecated because of the man who uttered it, i.e., a Roman soldier. Hence, the man is variously represented as saying that Jesus was *the* Son of a god (or gods) or *a* Son of a god (or gods) or *a* Son of God. Which did he say? Several points are of interest here. One is that the man was a Roman, but also a centurion. Consider the character and attitude about God and God's way in the following texts: Matt. 8:5-13; Acts 10:1ff.; Acts 27:1-3, 42-44. Three men in the preceding texts are of special interest, other than Jesus, Peter and Paul. What nationality were the men with whom Jesus, Peter or Paul had dealings? What kind of character did these men have in common? What position did these men hold in common? How do these three men compare in *faith* or *honesty* with the Jews as a nation? What makes you think that this Roman centurion could not have as much faith and ability to honestly weigh the facts as anyone else, be he Jew or Gentile?

The text of what he said is of interest too. As noted, you are given various alternative readings depending upon what translators think the man could have said. However, within a space of fourteen verses, we have texts that are comparable to v. 54b. in construction. Let us compare the following verses, considering 1) the Greek text, 2) the translation in R.S.V., and 3) the people who expressed the words recorded. (the Greek text is given in English transliteration for comparison.)

Mt. 27:40 (those passing by) "If you are the Son of God,"

Ei huios ei tou theou
(if son you are of the God)

Notice that there is an article (the) before the word "Son" in English, but there is no article in the Greek. Conversely there is no article before "God" in English, but there is one in Greek.

Mt. 27:42 (chief priests and scribes) "He is the king of Israel."

basileus Israēl estin.
(king of Israel is)

Notice that there is an article (the) before "king" in the English, but none in Greek.

Mt. 27:43 (chief priests and scribes) "He (Jesus) said, 'I am the Son of God.'"

hoti Theou eimi huios.
(that of God I am son)

Notice again that there is an article before "Son" in English, but none in Greek, but no article before "God" either in Greek or English.

Why not footnote these expressions to show that the Greek could be translated several ways? Is it because of a prejudice about what men could or could not say? Now, consider the centurion's expression with the Greek text transliterated.

v. 54b. "Truly this was the Son of God."

Alēthōs Theou huios ēn houtos.
(Truly of God son was this)

FINAL WEEK

We do not see any real good reason for deciding the centurion could not mean every bit as much by his expression as others who believed in God or Christ. He had seen signs for which there was no natural explanation—why could he not accept the natural testimony of such things? We think R.S.V. is correct in their translation. We do not see any good reasons for the footnote, if they are not going to footnote other texts that have similar constructions (laying aside the arguments over the problems of presence or absence of articles in Greek). The same criticism is applicable to other translations which do the same thing.

Matt. 27:55-56; Mk. 15:40-41 and Luke 23:48-49 mention the facts about onlookers at this time other than the soldiers, especially the women who were followers of Jesus. Luke notes that the multitude as a whole, when they observed the unusual events, went away in a state akin to that of the people who heard Peter recount facts about Jesus in his sermon in Acts 2. We wonder if some of these people standing around the cross were not also some of those who were convicted by Peter's sermon.

The day was Friday, but since this was Passover week, it was somewhat more special—a "high" day. The Jewish law, (Deut. 21:22-23; Josh. 8:29) had instructed the people of Israel that a man hanged was to be buried the same day. The day following was the Sabbath—no work was to be done on that day at all. If the men were not removed from the crosses before sundown, just a short time away, then they would have to remain on the crosses for at least 24 hours, dead or alive, until sundown Saturday. This was not a situation to the Jews' liking. Hence the request to Pilate. John 19:31-37 retells the response of Pilate—he instructed the soldiers to break the victim's legs, thus hastening their death, not only from the shock

and pain of such treatment, but also the added weight placed upon the arms and chest muscles which would already be strained from the unusual position.

So the soldiers came up to perform the command, and found the two men on the outer crosses still alive. They broke their legs as instructed. The man in the middle was to all appearances already dead. One of the soldiers, perhaps having been fooled before by a seeming dead man, or just to make positive, thrust his spear into Jesus' side. We do not wish to enter the arena of debate over the remark by John concerning the blood and water (see I Jn. 5:6) that came out at the spear thrust. What is the point to be made is that the soldier intended to make sure Jesus was dead (Pilate was reassured on this very point, Mk. 15:44). This is most important in view of the attempts by some down through the centuries who assert that Jesus merely swooned and recovered in the tomb. We surmise that John's remark in vv. 35-36 is to this end: the man Jesus was dead.

Several texts are of interest here—the type of Jesus in the O.T. was the passover lamb, so read Ex. 12:1-13, 46; as well as Psalms 34:20; Zech. 12:10; John 1:29.

Some have used the idea of blood and water to speak of Jesus' "broken heart." Such is inferred, not said. We seriously doubt that such a conclusion is to be drawn. Jesus died victoriously, not in disappointment. He voluntarily gave His life, Jn. 10:17-18, rather than getting killed accidentally. The cross was necessary, Lk. 24:44-46; the desire of Christ, Lk. 12:50; central in His life as seen in the transfiguration and at Gethsemane; planned right down to the day, Jn. 12:23, 27-28; 17:1; and memorialized until the second coming, I Cor. 11:26.

The spirit was gone, the body now dead (James 2:26). Nothing was left but to bury the fleshly body—

FINAL WEEK

but who was concerned enough to do it? One can not but wonder where Jesus' disciples were at the time of His death. Were they unaware that He had died? Others were aware He had died, however, specifically Joseph of Arimethea and Nicodemus. Joseph was rich, good, righteous, a counselor of the Jews, a secret disciple of Christ, looking for the coming of the kingdom, did not consent to His sentence, and came to bury Him at a time when the "faithful" were anything but. Nicodemus has come within view before, in Jn. 3 and Jn. 7. We can only marvel that these two were courageous enough to do what others would not do. God always has those who but need the proper time to bring out their best—such was the case with these two.

Nicodemus furnished a wealth of spices (myrrh and aloes), Joseph the place of burial. (Read Mt. 27:57-61; Mk. 15:42-47; Lk. 23:50-56; Jn. 19:38-42.) The sun's fading light cast long shadows from these two men as they first removed Christ's body from the cross and then carried it to the nearby garden tomb, being followed by Mary Magdalene, Jesus' mother Mary and some others. Hastily wrapping the body in the spices (note that women bought more spices and were planning to come to the tomb early Sunday morning to finish the hurried job) they laid the body on the slab of rock, rolled a stone across the entrance and left. It would be an understatement to say that many hopes and dreams were buried at the same time, or that the stone closed upon a body hardly as dead and cold as some of the plans and promises the disciples held prior to this tragedy. What was left but pieces? And these without rhyme or reason for re-assembly! Read Lk. 24:21 and I Cor. 15:19 now.

"Oh, what a tangled web we weave,
When first we practice to deceive!"

Yet it is true for all time—our sins will find us out (even as Moses told the people of Gad and Reuben in Num. 32:23, and as Jesus implied in Matt. 10:26), I Cor. 4:5! The Sabbath having begun (perhaps the time would be our Friday evening), the Jewish rulers remembered something Jesus had said (wonder why His disciples did not remember the same thing?) about rising the third day, Matt. 27:62-66. They went to Pilate and requested a guard for three days. The purpose: to prevent the disciples of Jesus from stealing His body from its resting place (they had observed not only that Jesus was buried but where and how). The Greek text is somewhat ambiguous, but we understand Pilate to grant their request, give them a squad of soldiers and also place a Roman seal on the stone which Joseph had rolled across the entrance to the sepulchre. The reader may rightly wonder if the Jewish leaders thought that all men, especially Jesus' disciples, were as deceitful as they were. The saying of Jesus about rising after three days (see under # 72 (15) for other discussion about the three days) is hard to pinpoint as to which one they heard. We readily recognize that the Gospel accounts may not record the particular time they are remembering. Jn. 2:13-22 is one time, but Jesus was understood a different way by the rulers. Maybe Matt. 12:38-42 is the text they have in mind.

We believe God provides in so many ways for those who love Him, or who work to see and hear truth. The request of the rulers for a guard greatly enhances the fact that the disciples did not steal the body, nor in any way remove the savior's body. He arose by the power of God, the power of Jerusalem and Rome notwithstanding! How little could God be contained in a tomb? Thus had He taught in Isa. 66:1; thus did Stephen teach in Acts 7:45-50 and Paul teach in Acts 17:24-25. He is so great that the whole universe bespeaks His glory, and so loving

FORTY DAYS AFTER THE RESURRECTION

that He will gladly live in your heart—if you will let Him.

“Then sings my soul, my Savior God, to thee,
How great thou art, How great thou art!”

FORTY DAYS AFTER THE RESURRECTION

(21) “Now after the Sabbath, toward the dawn of the first day of the week” reads R.S.V. in Matt. 28:1. The text seemingly says that the women came on early Sunday morning. However, the Greek word translated “after” (opse) can also mean “late” as is patently evident in Mk. 11:11, 19; 13:35, which we give in part for study.

Mk. 11:11 “as it was already late (opse)”

Mk. 11:19 “and when evening (opse) came”

Mk. 13:35 “in the evening (opse), or at midnight”

Hence the text may be understood as affirming that “late on the Sabbath” the women came to the tomb, just to see it, with the “ending” of the Sabbath and the “dawning” of Sunday imminent. There was no particular reason why such a visit could not be made. Consider that Mk. 16:1 may be describing part of their activity on (our) Saturday evening, which could have been done while going or coming from the tomb. It is fair to say, however, that this position makes the word “dawning” refer to the beginning of the day, not to the rising of the sun, as is our usage. Thus the text may be understood by some one way and by some another.

We should note that Matthew’s account does not say 1) that the earthquake occurred when anyone was present except the guard, nor 2) that the stone was rolled back to let Jesus out, nor 3) that the soldiers did/did not see

Jesus, nor 4) that the women saw the angel descend and/or roll the stone back. The text does mention that the angel anticipated their (women) fear and sought to allay it. The guards were greatly afraid (the Greek word describing their alarm is the same as in 27:51 describing the earthquake). We wonder in passing how Matthew found out all these things—did God reveal them to him?

As you think now about the resurrection of Jesus, consider that the resurrection means more than spring-time (God ordained seasons in Gen. 8:22, long before any resurrection occurred) and new flowers. It is not simply a symbolic way of talking about immortality (the disciples were not persecuted for believing/preaching in that!). It was not something done in a corner somewhere, unprovable by human methods. Rather, we are to remember "Jesus Christ, risen from the dead" II Tim. 2:8; and glory in the "power of His resurrection" Phil. 3:10; knowing that our preaching is with the power of God in an endless life, Acts 2:29-36; II Tim. 4:1-5; Heb. 7:15-28. It is the surety of judgment and life Jn. 5:28-29; Acts 17:30-31; Rom. 6:1-8; and that which makes our baptism valid, I Cor. 15:19; I Pet. 3:21. It verifies that Jesus is the Master of all, including the sentence of physical death through Adam, I Cor. 15:24-26, 51-57; Rev. 1:17-18; 5:6-14; 22:20. If you can (as suggested in our introduction, either buy a Gospel harmony or make yourself-one), study the following sections together: Matt. 28:2-8; Mk. 16:1-8; Lk. 24:1-11 and Jn. 20:1-10. These are four separate testimonies to the resurrection. Each varies from the others in some respects, though all testify to an tomb empty because of the bodily resurrection of Jesus of Nazareth, the Christ of God. No account denies what another affirms, though each relates some events omitted or described differently by others. As examples of what we mean:

FORTY DAYS AFTER THE RESURRECTION

1) Mark names three women who came, Matthew names two though not denying others went along, Luke names three and mentions others (see v. 22 also), while Mary Magdalene implies more than herself in Jn. 20:2.

2) Matthew does not say when the women came or when the earthquake occurred, Mark says that the women went "very early", the sun having risen, Luke has "early dawn" while John says "early, while it was yet dark." All could be true depending upon the particular time in mind by the writer.

3) If we decide that Matt. 28:1 refers to the Sunday morning visit, the women came to see the tomb, though Luke says that the visit was to finish what Nicodemus and Joseph had begun: anointing Jesus' body. The women had bought spices for this very thing. John's account does not specify any purpose, yet no account denies what the other affirms.

4) The women do not know how the stone was to be rolled back, but discover that they need not worry, because when they get close enough to see, the stone is already rolled back. We are not told why they were worried about this fact. The question may center around permission to get it rolled back (remember the Roman seal?) rather than who had the physical strength to do so.

5) The accounts differ as to exactly what the women did when they arrived at the tomb, Mary Magdalene not being with them because she had left to get Peter and John. Matthew does not affirm or deny entry into the tomb, though the angel told them to "Come and see where Jesus had been lying." Both Mark and Luke affirm entry. Then John, describing only Mary Magdalene's return, relates that she stooped to look in, but does not say she went in. She had not gone up to the tomb on the first visit, but

had turned and ran away to tell Peter and John what she incorrectly assumed when she saw the stone rolled away: the body had been taken.

6) Remembering that Mary Magdalene did not complete the trip to the tomb the first time though later returning after the other women had left (as well as Peter and John having arrived and left), the women saw an angel outside the tomb per Matthew. He does not say anything about angels being inside the tomb. Being instructed by the angel on the outside to "see" for themselves, Luke tells us that the women entered the sepulchre and saw two angels inside (though Mark does not specifically mention but one "young man," he does not deny what the others affirm). John mentions that Mary Magdalene saw two angels when she looked in, though Peter and John did not have angels appear to them. Again, no account denies what the others affirm as true.

7) The women, minus Mary Magdalene, are told approximately the same message by the angel outside and those inside, according to Matthew and Mark, though Luke's account adds the fact that the angels said Jesus had told them of His approaching death, burial and resurrection. John's account only has the angels asking Mary a question. Which denies what the others affirm?

8) When the women, yet minus Mary Magdalene, leave, they are instructed to tell the disciples of Jesus, both by the angels and by Christ Himself, Who met them on their way back. Some have thought there is a contradiction between the accounts, however, for Mk. 16:8 affirms they said nothing to anyone. We might wonder if they disobeyed the message, but Luke vs. 8 and vs. 22-24 flatly say they obeyed exactly. We thus can understand Mark to specifically say that the women told only those whom

FORTY DAYS AFTER THE RESURRECTION

they were to tell, and no one else but. John vs. 18 likewise affirms that Mary Magdalene told the disciples, but does not say she told anyone else.

9) Some find problems with the command by the angels to the women to the effect that they were to go to Galilee where Jesus would meet them. As a matter of fact, the message of the women was not believed, though Peter and John saw the tomb empty. No one really began to accept the truth of Jesus' resurrection until that evening when the testimony of the women, Peter, the two men on the Emmaus road, plus the personal appearance of Jesus convinced them. As a second matter of fact, the disciples did go to Galilee, and Jesus did meet them there, Matt. 28:16-20; Jn. 21:1ff., (which, by the way, is the reason they were there. They did not lose faith in Jesus and decide to go back to the fishing business, etc., as some suggest. But see Jn. 21).

10) The appearance of Jesus to the women on their way back to their homes (or wherever they were going—we do not know where the "disciples" lived whom they were to tell) and the later appearance to Mary Magdalene in the garden have caused some a problem in this way: Matthew vs. 9 relates that the women "took hold of the feet of Jesus." However, this is thought to contradict Jn. 20:17 where, according to the King James version, Jesus told Mary to "not touch Him." The problem is exclusively with the poor translation in John found in the King James version. The reader must remember that 1) the King James version is in English, not in the original language of Greek, and was not translated into English from Greek until 16 centuries *after* the accounts were written in Greek, and 2) *no translation is inspired*. Only the original manuscripts were inspired as they were written by Matthew the apostle, etc. The Greek of Jn. 20:17

has a verb which has various shades of meaning (as do *all* words, to a greater or lesser extent). Consider the following occurrences, with the word italicized translating the Greek word, *haptō*:

Mt. 9:21 "If I only *touch* his garment"

Mk. 10:13 "that He might *touch* them" (note in vs. 16 that Jesus holds them)

Lk. 8:16 "no one who *lights* a light"

Acts 28:2 "They *kindled* a fire"

I Cor. 7:1 "It is allright for a man not to *touch* woman" (the context obviously has in mind a sex relationship)

The basic meaning is to "lay hold of" or "grasp onto," (consider Matt. 8:15 and Mk. 1:31) hence metaphorically to pick up and light a candle or build a fire from wood, or take a partner in marriage. The tense (a present imperative form) in Jn. 20:17 is important to understanding what Jesus said and in understanding the meaning of this word. Mary had grasped Him and was continuing to do so. He told her to "Quit holding on." Likewise in I Cor. 7:1, Paul used a present infinitive to show that marriage was a constant "holding on," i.e. possession of someone.

No account contradicts the other, anyway, even if the translation in the King James were correct, which it is not. Jesus could have had a reason for allowing the women to touch Him while forbidding Mary Magdalene to do so. The women left, both fearful and joyful (note Lk. 24:41), with news they could scarcely believe. We can but wonder with what amazement the disciples whom they contacted listened, doubtless greatly interested but also unbelieving. Have you ever tried to convince someone who refuses to accept that which you know assuredly to be true? Lk. 24:11 has a word translated "idle" in

FORTY DAYS AFTER THE RESURRECTION

R.S.V. that meant something akin to nonsense, wild hysterical talk. That is how it seemed to be. The accounts do not say anything, but one can but wonder what Peter and John said to those whom they saw, especially if they contacted the women or others who had heard the women's story. What effect did Mary Magdalene's story have do you suppose? We are likewise not told when Jesus appeared to Peter (did you note Mk. 16:7?), whether during the morning or later in the day. Perhaps they all did not get together until the meeting in the evening, since Sunday would be a day of work for some, despite the Passover feast. Perhaps the great multitude at the feast prevented the contact with but a few (have you ever tried to find someone at a large gathering?), even if no work was done. Remember: fear of the Jewish hierarchy might have slowed down efforts to reach others until darkness set in, permitting easier movement.

Leaving the accounts of the appearances for a moment, note Matt. 28:11-15. The guards would normally have been put to death (see Acts 12:18-19) for allowing such to happen, or falling asleep on duty. Yet the story they were instructed to tell was exactly that: "We fell asleep, and the disciples (how would they know who it was if they were asleep?) stole Jesus' body while we were asleep."

Incredible! Besides, why steal the body? They had not any reason to do so, nor had the governor said they never could have the body. Who wanted it anyway? And for what purpose would they steal it? Who among the unbelieving disciples would conjure up such a story as they later told, and gave their lives for it?

Treachery — illegality — slander — bribery: but truth would not down! But some closed their eyes and ears, lest seeing and hearing they would believe and be healed, Matt. 13:15. Jesus often wept over the people in Jerusalem because they willed not to receive Him, Lk. 19:41-

44, and challenged them to figure out how they could escape judgment to hell, Matt. 23:33. Yet others were like good soil, and turned the world "rightside up" because of a firm conviction about a resurrected Jesus of Nazareth, God's Messiah.

A chronological outline has been provided in the front of the book. It differs in only one respect from those commonly presented in that Jesus is presented as appearing to the women before the appearance to Mary Magdalene. As a point of discussion, Jesus appeared to Peter, and He may have done so before either of the two appearances in question. The texts do not say one way or the other.

Should the reader be unaware of the textual problem about Mk. 16:9-20, a brief discussion is in order. The student who wishes to really pursue the matter should consult some detailed study like that of Kenyon in his *Handbook to the Textual Criticism of the New Testament*, Lightfoot in *How We Got Our Bible*, the commentary on Mark by Gould or Swete, others of like nature, books on N.T. Introduction, or critical notes in some Greek N.T.

For those who use only the translation known as the King James version, or have a translation that gives only the longer ending of 12 verses, we hereby give the short summary text which some Greek manuscripts have in lieu of the longer text (as in R.S.V.):

"But they reported briefly to Peter and those with him all that they had been told. And after this, Jesus himself sent out by means of them, from east to west, the sacred and imperishable proclamation of eternal salvation."

The problem is many sided, and probably impossible to decide beyond any doubt. The text has been the subject of textual discussions since the second century A.D. We do not suppose we can settle it now. The Greek

FORTY DAYS AFTER THE RESURRECTION

text we use to translate our English N.T. is a result of many men's labors over centuries. There are many copies of Mark's Gospel among the 5,000 Greek manuscripts of our N.T., not to mention the copies in Latin manuscripts, Egyptian, etc. Though the greater part agree together about the rest of Mark, 16:9-20 is not so agreed upon. The manuscripts variously present 1) a short summary ending, 2) a longer ending as is found in the common versions, 3) both endings with indications of uncertainty about which is right if either, 4) neither ending, though some indicate that the person copying the text knew of other endings than that of 16:1-8. Quotations and/or remarks about this portion of Mark by Christian writers of the first 400 years are generally against the genuineness of this text. Thus, *external evidence* for these 12 verses is not very good at all.

Internal evidence is that which deals with what the writer would have (probably) written. Like external evidence, it is subjective, not objective. So no one can say conclusively what the truth is. Internally, the passage of 16:9-20 is:

- 1) in a different style than the rest of Mark,
 - 2) uses words in different ways than in the main text,
- and
- 3) uses words not contained in the main text.

Yet such arguments as these can be countered with the statements that:

- 1) Mark simply quit the more detailed narration and summed up the rest as in the opening verses of chapter 1, or that,

- 2) since the subject matter is different, a. words would be used in somewhat different ways, or b. even new words used (as is the case with Lk. 24 compared to

the rest of Luke) which were not needed before. Thus, the case stands.

We think that the evidence for exclusion is rather more than that for inclusion. No doctrine is lost that is not basically taught other places. No resurrection appearance is found which is not elsewhere.

In regard to the statement that Jesus appeared to Mary Magdalene first, we reply, ahead of whom? The mention of the appearance to the other women is left out entirely, as is that to Peter. The appearance to the eleven is not located as to day or time. Mary Magdalene simply is first in the appearances Mark gives.

Consider this idea: The women were close enough to see that the rock that closed the tomb entrance had been rolled back. Mary Magdalene, as the rest, assumed the body had been taken. She turned and left to go find Peter and John. The rest of the women went to the tomb, where they saw the angels, and viewed the empty sepulchre. They left (the text says "ran") with the news of Jesus' resurrection. Mary Magdalene had not yet returned, nor had Peter and John arrived when the women left. They met Jesus on the way back into the city. If they traveled the same road back to the city which Peter and John used to come to the tomb, they met Jesus but did not meet Peter and John, nor Mary Magdalene, since these three did not hear about the resurrection until they had been to the tomb or had left the tomb. Peter and John arrived and left before Mary Magdalene arrived (whether they passed on the way or not is debatable, as are many other things left unsaid). We think because of the time element and the distance involved, Jesus met the group of women going back to the city before Peter and John or Mary Magdalene ever got out of the city coming to the tomb. The only evidence that Jesus appeared first to Mary Magdalene is the statement in Mark, which is questionable

FORTY DAYS AFTER THE RESURRECTION

for several reasons, not only for the integrity of the text itself but also from the nature of the appearances listed. However, no one's salvation depends on the solution to this issue, or to the inclusion or exclusion of Mk. 16:9-20.

Jn. 20:11-18 relates the appearance of Jesus to Mary Magdalene. She arrived at the tomb but no one else was around (as mentioned above, whether or not she met Peter and John on her way back to town is unsaid, but doubtful). Just why the vision of the angels inside the sepulchre made no impression on her is unsaid. Maybe she did not see them well enough to tell that they were angels. Perhaps they did not appear as angels (remember Abraham in Gen. 18)? just then. Who really knows? We are not even sure why she did not recognize Jesus but rather assumed He was the gardner (but the two men on the way to Emmaus did not recognize Him either, and the case may have been with her as with them). Perhaps she was looking for something rather than someone. Often we see in life what we want to see, and do not see what we wish not to see.

Though she neither recognized Jesus' form (did He appear so "human" that nothing noticeable was present?) nor voice the first time, when He spoke again (calling her name) she then realized the person was Jesus. He then forbade her to detain Him, and sent her to the brethren with the message of His ascension. Of course, the fact of His resurrection is also evident, and she added her testimony to that of the other women.

Just what Jesus meant by His expression "My God—your God," "My Father—your father" is in doubt. Perhaps it was His way of differentiating the specific relationships that existed for Him with God, contrasted to the rest, or maybe to impress her with the fact that all sustained similar relationships with the divine being, Who was both *God* and *Father* (remember the instructions in the model

prayers—Matt. 6; Lk. 11?). For us, the passages in Acts 2:36; Eph. 4:8-12; Phil. 2:9-11; and Heb. 6:19-20 come to mind.

Likewise, the second coming as seen in Acts 1:6-11; Col. 3:4; II Thess. 1:5-10 and other passages is also brought to mind.

Trip to Emmaus—Lk. 24:13-35

Great crowds thronged the sacred city, surging up and down the narrow streets and through the temple grounds. Emotions were at a high level because of renewal of friendships, and/or of the religious festivities. Yet among the hundreds of thousands of people in and around the city of peace, some few were in a chaotic state of mind. It was heart-rending enough to watch in unexplainable horror and fascination as the hopes and dreams of a lifetime were rudely pinned to a cross. It was yet more emotionally draining to have some women, joy and fear alternating in their voices and on their faces, to come and insistently affirm that same Jesus Who had died on that cross was not wrapped in myrrh and spices inside a tomb but rather clothed with life, a walking, talking reality.

So Luke brings into the range of our vision "two of them" (of the group in v. 9?), Cleopas and a companion winding their way toward Emmaus. The sun was on its way down, westward over the Mediterranean Sea, as they walked and talked, their destination some 7 miles north west of Jerusalem.

Doubtless many were coming and going, but one of those, for some unknown reason, drew near and posed a question: "Would you mind telling me about this 'whatever-it-is' you're discussing?" (The Greek term translated "discussing" conveys the idea of lively conversation, debate or dispute. Jesus used a word that would bring to mind

FORTY DAYS AFTER THE RESURRECTION

two boys tossing a ball back and forth as He asked about the ideas and questions the two men were tossing back and forth.)

The two men stopped by Jesus' "a penny for your thoughts" question, looked very downcast (The Greek term "skuthros" indicates gloomy or disheartened in countenance). Cleopas asked, "Are you the only stranger around who is ignorant of what has happened lately?" "(I guess so)—What happened?" So the two assumed that the stranger was not aware of their present distress, and picking up their feet as well as the story so vivid on their minds, they shared the events about Jesus as they headed homeward.

The pieces just would not fit, as they saw it. All square blocks for round holes it seemed. To compound the enigma, the empty tomb and the incredible story of Jesus being alive was thrown into the seething mass of information. Peter and John verified the empty tomb, the neatly folded grave clothes and head covering, but that was all. Could the facts be fitted in? And so they talked.

Hopes cherished so long ("we had been hoping," v. 21) were tough to throw away. The action of their rulers in condemning Jesus to death (the present day decision to exonerate the Jewish hierarchy notwithstanding) was simply incomprehensible—and then came Sunday's news: worse and more of it! Jesus had been so mighty (the Greek word is "dunamis," as in Rom. 1:16) in both actions and speech—"Well, it does not make sense, sir!"

God makes things meaningful—He puts the pieces all together, and makes things complete. And so He did for these two men. He knew they were simply ignorant of the facts (or the relationship of facts to other facts) and He also knew why: their dull perception through unbelief (note Eph. 4:17-19). It seems so impossible that

NEW TESTAMENT HISTORY: THE CHRIST

these men, with the rest, could have missed so greatly, could have really missed the most important parts of God's word to them. But we know by experience, vicarious and/or personal, just how easy that is, do we not?

Jesus presented the men with the secret of their puzzle: a suffering Messiah, (note Jn. 12:34). The thing that bothered them the most was the most important thing! God was to be manifest in the flesh, and give men a chance for life through His death (John 12:24-26), and then arise to live evermore in glory (see Jn. 17:5, 24; Acts 2:36; Phil. 2:9; Col. 1:27). He was to produce new life through His death, to bring men alive unto a living hope by means of His resurrection, I Pet. 1:3.

Norman Geisler and William Nix in *A General Introduction to the Bible*, page 18, have an excellent chart presenting some ideas about Christ that we need to see, perhaps as much as the two men in our text:

In the O.T. Christ is:	In the N.T. Christ is:
in shadow	in substance
in pictures	in person
in type	in truth
in ritual	in reality
latent	patent
prophesied	present
implicitly revealed	explicitly revealed

The men were so engrossed in the "new slant" of the knowledgeable stranger that the distance to Emmaus was soon covered. The men, unwilling to allow the man to part from them, invited him to linger for the evening meal. Perhaps the demeanor of the man made it a natural, or out of courtesy, the two men had their visitor give thanks for the food. As he began to break the bread, they saw for the first time beyond that which was being given to him who was giving it—the man was Jesus! At

FORTY DAYS AFTER THE RESURRECTION

the moment of recognition, He became invisible. The Greek term means hidden, unseeable or something of the nature. Texts such as Mt. 6:19 in regard to the results of moths and rust; Heb. 8:13 referring to the old covenant; or James 4:14 about the vanishing life, have this word.

The text does not really state if the Lord supernaturally caused the men not to recognize Himself for a while, or if He simply was not recognized because of their preoccupation, or what the reason was. The case of Mary Magdalene is akin to this as well as that of Lydia in Acts 16. There would be no particular problem if He did however.

Doubtless the two men, their lives once sad and thoughts strangely accusing, traversed the intervening distance to Jerusalem in short order. Arriving in great haste, they discovered that their good fortune was also that of Peter. With voices understandably excited, talking all at once, the "eleven" (Thomas was absent, Judas dead, so actually only 10) plus Cleopas and his companion, plus some women, exchanged the news, so unbelievable and yet so certain. How very thrilling to "see" the truth at last, and to enjoy fellowship with others who were of the same mind.

Jerusalem—Lk. 24:38-43; Jn. 20:19-35

"Disfellowship them"—Thus was the decision of the Sanhedrin for anyone who confessed Jesus as the Christ, Jn. 9:22; 12:42-43. However, the decision implied perhaps more than mere ostracism from the synagogue—and the disciples so understood, Jn. 11:16. Hence, we may perceive the reason for the closed doors of the room in which the jubilant disciples were meeting.

Both accounts seem to imply that Jesus as suddenly appeared within the room as He disappeared in the room

at Emmaus. We do not see any reason whatsoever for supposing that His body was any different than it was before the resurrection. Walking on water is not any more humanly possible than materializing within a room. People looked at Jesus and thought He was human. He says as much Himself in our text, and eats food to convince any skeptic. The idea some present that Jesus had a different body after the resurrection than before has no basis in the texts. The converse is true, if anything. Thus He could show His nail-pierced hands, feet and side as evidence that the body was identical to the one the disciples knew. His power and usage of the fleshly body was self-limited as He chose. It is interesting to consider that Jesus did not and does not ask for blind faith, with no evidences for faith. In His infinite wisdom, He has given enough evidence to bring us to a position of faith, if we are willing to consider it.

Having given the disciples ample reason to joyously believe (at first, it was too good to be true apparently, Lk. v. 41), and bestowed upon them His very own peace, He breathed upon them (remember that the disciples were Hebrews, and the Hebrew word for wind, breath and/or spirit of God was the same, as is true for the Greek word *pneuma*. Hence, this had much more meaning for them than us, to whom it seems a bit odd) and instructed them to receive the Holy Spirit Who was to come to them with power, Acts 1:8. We assume the actual reception was some 50 days later on Pentecost, as recorded in Acts 2.

We remarked under Matt. 16:18-19 about the role of the disciples in regard to the revelation from God which they were to proclaim. God was going to reveal through them what no eye had seen, nor ear heard, nor man imagined, I Cor. 2:6-13, which explicitly teaches that the new covenant was a revealed covenant from God.

FORTY DAYS AFTER THE RESURRECTION

It was given to all men through the apostles and completed within their lifetime. No new revelation from God was to be or is to be expected from that day until Jesus returns. The whole text in I Cor. 1:18-3:23 is about this very point. The text in I Cor. 2:14-16 is an affirmation of one fact, and one fact only: the message came by Spirit-directed men, not otherwise. These men, revealing the mind of Christ (Jn. 16:14 declares that the Spirit will take what belonged to Christ and give it to the disciples), stated for all time the will of God for all men everywhere. As Paul says, the apostles taught the message as directed by the Holy Spirit, 2:8-13. Thus did Jesus teach in Matt. 16:19; 18:18 and Jn. 20:23.

If you read the texts just mentioned in Matthew and John rightly, they will say what the Greek says. However most people do not do so, thus we give a translation of the Greek text for help in understanding, both of Matt. 16:19 and John 20:23: 16:19 "Whatever you make binding (Greek: *deō*) upon earth has already been made binding in heaven. Whatever you make free upon earth has already been freed in heaven."

The disciples simply were instruments through whom God spoke to men, either giving direction for obedience or releasing from obligation. The Greek word (*luō*) translated "make free" or "has already been freed" means to unloose, untie, or release. The expression "has already been freed" translates a Greek perfect, which carries the idea of something already done and remaining done up to the point of speaking. God had planned to save men from sin through the new covenant, had so prophesied, and now was revealing that plan. 20:23 "If you extend forgiveness of sins to any man, those sins have already been forgiven. If you do not extend forgiveness for anyone's sins, such sins have not been forgiven."

The idea in this verse is that the apostles were to preach conditions (terms) of forgiveness for sins (as in Acts 2:38; 13:39). However, by the same token, such proclamation would exclude any other way of forgiveness for sins, God expressing His will through their preaching. Now read Acts 4:12 in this light. God had already decided that Jesus was the means to forgiveness. The apostles so preached, extending salvation from sin through Christ alone (Rom. 5:1; 8:1). Any other "way" was a false way. And no sins would be forgiven through such ways.

The Greek word translated with the idea of forgiveness is variously translated as "let go," "send away," "abandon," "divorce," etc. (It is *aphiēmi*.) The Greek word translated "do not extend forgiveness" conveys the idea of "arrest," "retain," "grasp," etc. (It is *krateō*.) If the listener did not accept the terms of pardon, his sins were still charged to his account, and he was still in the grasp of sin.

Thomas the doubter—history has so dubbed this disciple of Jesus. We do not think the title is very well given. The account in Jn. 20:24-25 has Thomas refusing to believe unless and until he could verify the man was really Jesus. The reader may well recall that the rest of the disciples did not believe, either, until Jesus personally appeared to them—and even then He had to eat food in their presence, and show them His hands, feet and side! Another item of interest: Thomas was a twin (King James "didymus")—he might well have known how very easily people mistake one person for another.

Jerusalem—Jn. 20:26-31

Eight days later (the following Sunday evening—note the inclusive way of counting time) Jesus again

FORTY DAYS AFTER THE RESURRECTION

appeared to the men in the same way as the first time. Thomas received his request, as Jesus offered to show him the pierced hands and side. Each demand of Thomas received attention from Christ. His confession was immediately forthcoming, but it would have been better to have accepted the testimony of the others. However, Jesus definitely was alive, the same Jesus who had been crucified and buried. The men were completely convinced by adequate testimony that Jesus was alive. How firm is the foundation of faith—God does not make unbelief a mark of intellectual inability, but rather of volitional refusal to accept the evidence.

The exclamation of Thomas is most interesting insofar as it would not have been uttered by any Jew, ordinarily. To be persuaded that a human could also be deity was a tremendous step for any Jew. Of course, this very idea that Jesus was both divine and human was the charge leveled against Him at the Jewish trials, and for which He died. Like Peter and the others in Matt. 16, Thomas had accepted the revelation of God through Jesus as to the actual identity of Jesus: He was the Messiah (Christ) of God.

Yet we are not treated to all the evidence Jesus gave the disciples after the resurrection and before the ascension. Jn. 20:30-31 teaches that the 40 day period was given over to teaching and convincing the men about Himself (see Acts 1:1-11). However, by means of inspiration John tells us that the information contained in his book is adequate to bring a person to faith in Jesus, and that faithfulness to the point of death is the key to life here and hereafter. The Greek text of v. 31 tells us that 1) we can come to a personal faith in Christ, thus committing our lives into His care, and 2) as long as we keep on trusting (the Greek participle "pisteuontes" is in the

present tense, normally implying a constant state) we keep on having (echête) life, even as I John 5:11-12 teaches: "God gave us eternal life, and this life is in his Son. He who has the Son (ho echōn ton huion echei tēn zoēn) has life; he who has not the Son of God (ho mē echōn ton huion tou theou tēn zoēn ouk echei) has not life" (RSV).

Galilee—John 21:25

"Let's go fishing." "Okay, let's go." Seven men, including Peter, James, John, Thomas and Nathanael, were in Galilee (as were other disciples of Jesus) *at Christ's command*, Matt. 28:7, 10; Mk. 16:7. While awaiting His appearance, these men decided to spend a night fishing, likely to catch enough fish to provide income for their families. The night passed, though, and the nets repeatedly were empty. Fishing is often work, and to toil all night and catch nothing makes the "sport" even more work.

Faint steaks of dawn had given way to the dawn's light when a voice came winging its way into the disciple's attention: "Children, you do not have any fish, do you?" (N.A.S.). Expecting a negative response because He knew they had caught nothing, Jesus instructed the men to try the right side again. Obedient, even if they did not know who the person was, the net they cast enclosed 153 large fish (John remembered that for a long time!)! The text does not say, but we assume the catch of fish was miraculous. The disciples seemed to react the way they did because they so thought. We believe that the catch of fish was more than a lucky guess. However, Jesus might simply have supernaturally known that the fish were there rather than creating them and putting them there.

FORTY DAYS AFTER THE RESURRECTION

Whether all thought the same thing at the same time or not, John put the voice (and probably the catch of fish in Luke 5) and this catch together, and came up with Jesus. Peter, hearing John's exclamation, threw on an outer garment of some variety (he had removed his outer clothing for ease in fishing) and leaped overboard heading for shore. The rest of the men followed in the boat, bringing along the fish in the net, which was rather remarkably still intact.

"Let's eat" was the cheery greeting they heard from Jesus, and "Bring some of those fish." The Lord always provides, but expects us to do our part! The men, as did John, knew their host was Jesus—who else?

John remarks that this visit of Jesus with His disciples was the third. We understand this remark to refer to the appearances recorded only in his Gospel. This would be a natural statement, since at the time of writing, the Gospel was not "published" with Matthew, Mark or Luke—just by itself.

Their overnight fast broken, the conversation between Jesus and Peter began. Whether by design or not, Jesus asked Peter three times concerning their relationship, and each time gave Peter a command in response to Peter's reply. The New American Standard gives the commands as:

- v. 15 "Tend My lambs."
- v. 16 "Shepherd My sheep."
- v. 17 "Tend My sheep."

R.S.V. translates:

- v. 15 "Feed my lambs."
- v. 16 "Tend my sheep."
- v. 17 "Feed my sheep."

For those of you who would be interested in the Greek terms used here, the following is submitted:

- v. 15 Boske ta arnia mou.
- v. 16 Poimaine to probata mou.
- v. 17 Boske to probata mou.

Each time, the verb form is imperative and of continual force. Jesus meant a lifetime occupation, a daily concern for the nurture of Christians anywhere and everywhere. All the apostles caught the idea, even Paul, as is seen in Acts 20:31 and II Cor. 12:28. One of the reasons was that they recognized the fact that the devil "prowls around like a . . . lion, seeking someone to devour," I Pet. 5:8. The devil is not particular: any lamb or sheep will do. Hence, the imperative to feed and care for every one in Christ, to build them up in the "most holy faith," Jude v. 20. The work of the whole church is to do this, Eph. 4:10-16.

Comments about the relationship between Jesus and Peter will follow, but we wonder what the antecedent of the word "these" in v. 15 is. Jesus does not say specifically what He had in mind, the other men as a group or individually, either in their love for Jesus or Peter's love for Jesus as compared to theirs, or even Peter's love for them as compared to Peter's love for Jesus. It may be that the word refers to the fish, or the boat representing the fishing business, etc. Perhaps Jesus gestured so that Peter knew what was meant. Considering the total idea, however, Jesus may well have meant this: "Peter, is there anything or anyone in your life more important to you than I am?" Actually, as in Matt. 10:34-39 and Luke 14:25-35, Jesus must of necessity be first. Nothing less will do, either that we might please Him or supply sufficient motivation that implicit obedience to His commands will be forthcoming. If we love Jesus, self must go (Luke 9:23) and His tasks done. Our total desire will be for Him (Phil. 3:10) and to please Him (II Cor. 5:9). Only in so living will we find self and save self, Lk. 9:24. Thus, when affairs of life turn against us, Jn. vv. 18-19, or even when we do not under-

FORTY DAYS AFTER THE RESURRECTION

stand why others are seemingly treated "better" by the Lord, vv. 20-22, we will not hesitate even for a moment, but will go on trusting in the Master, the Great Shepherd of the sheep, Heb. 13:20.

We note in passing that the writer John was intently "eavesdropping" as Jesus and Peter talked. The verses in 23-24 are interesting in that the common (?) idea later held was that John was to outlive Peter. As nearly as we can tell, he did do so, even if Jesus did not really say what (John records that) some thought Jesus said. The Bible does not record the death of either man. Various traditions are around, yet none are very helpful. Common tradition has Peter dying in Rome, crucified head down. This is without any basis in fact, and hardly worth mentioning. John seemingly lived until the close of the century, and wrote his five books much later than the rest of the men whose books are in the N.T.

The discussion of Jesus and Peter is valuable for many things. The fact that two different Greek words are used for love is of abiding interest. The two words overlap to some degree as can be seen in the fact that both involve will, reason and emotion, the characteristics that are inherent in every spirit (person), God included. Yet, like all synonyms, complete overlap does not exist,

The Greek language had at least four words for love which had some things common among them. One of these is the word which comes into English in the adjective form "erotic." This word does not appear in the N.T. The second of the four words only appears once, Rom. 12:10, with the idea of affection or love. This word in the literature of the day carried the idea of affection for family, but also for one's nation, etc.

The other two Greek words appear numerous times in the N.T., and these are the focus of discussion. The

English transliteration of these two is *philia* and *agapē* as they are in the noun forms. In the conversation recorded between Jesus and Peter, the word *philia* (in the verb form) is used by Peter each time he answered Jesus. He did not use the word *agapē*. Jesus used *agapē* (in verb form) in the first two questions to Peter, *philia* (in verb form) in the third question. This presents the problem: What do the words mean? Why did the two men use different terms if they meant the same? If they did not mean the same, what was the essential difference? To this we now attend.

The words in the literature of the day show some difference. *Philia* was often used of one's feelings for husband or wife, for those close and precious. It is said of Antony in regard to Cæsar, "You loved (*philia*) him like a father, and also regarded him as a benefactor (*agapē*)."
Agapē rarely appears except in religious literature, but was used in Classical Greek with the idea of greeting with affection. It also was used with the idea of contentment with something, as one's satisfaction for a precious stone, etc. It carries the general impression of the set of the mind towards something, or someone. A desire for the good of that object but not with selfish motives or a desire to possess the object is conveyed. An attitude of real concern, no ill-will or pettiness, but of invincible good will is characteristic of *agapē*.

The N.T. presents a somewhat varied usage as could be expected. (All words have various shades of meaning.) Consider that *agapē* is used of God's love for the world (Jn. 3:16), for Jesus (Jn. 15:9), for the disciples who love Jesus and keep His words (Jn. 14:23). We are to love one another this same way (I Jn. 4:11-12) and God (I Jn. 5:1) but not the world (I Jn. 2:15). Many other relationships could be given, and references multiplied in this way. But the story is not all told yet.

FORTY DAYS AFTER THE RESURRECTION

Philia is used in the following ways in the N.T., and some of the references are worth considering with Peter and Jesus in mind. Philia often occurs in names, such as Philadelphia, Philemon, Philippians, Theophilus. Then, to facilitate study, we list the following:

Love what is good—Titus 1:8

Love one's husband, and children—Titus 2:4

Love for mankind, hospitable, benevolent—Titus 3:4 and as in Acts 27:3; 28:2; Rom. 12:13; I Tim. 3:2; Heb. 13:1

Love one's brother and sister—I Pet. 3:8

Love of money (avarice)—I Tim. 6:10; Luke 16:14

Loving oneself—John 12:25; II Tim. 3:2

Love (friendship) of the world, not God—II Tim. 3:14; James 4:4; and Rev. 22:15

Love of wisdom (philosophy)—Acts 17:18; Col. 2:8

Love of dispute, strife—Luke 22:24; I Cor. 11:16; III Jn: 9

Ambition or aspiration—Rom. 15:20; II Cor. 5:9

Devotion or kindly disposed—Mt. 11:19; Lk. 7:6; 11:6, 8; 15:9; and Acts 19:31

Love for family or God—Mt. 10:37

Paul's love for brethren—Rom. 16:22; Titus 3:15

A kiss—Mt. 26:48, etc.

God for people—Rev. 3:19

God for Jesus—Jn. 5:20

God for disciples—Jn. 16:27

Disciples for Jesus—Jn. 16:27

Jesus for Lazarus—Jn. 11:3, 36

Jesus for John—Jn. 20:2

These references out of the N.T. are enlightening when we consider Peter and Jesus. Peter could hardly be expected to use *agapē* when responding to Jesus. Of course, he had his mind set of Jesus' good! Over and over he had demonstrated that. He went far beyond that stage; for

he was emotionally involved. His whole being was involved! No wonder he responded as he did. Do you think Peter could be detached from Jesus? Aloof? Unemotional?

Perhaps we will be a bit more careful in holding up *agapē* as the love God has for all. That is true, but it is a long way from all the truth. The N.T. certainly expects us to get "attached" to husband, wife, each other, and "un-attached" to self, material things, etc. It is likewise interesting to note that the translation of the Hebrew O.T. into Greek (the Septuagint) uses both of the words of God's love for mankind. The Syriac version makes no distinction. How do you think Peter loved Jesus?

The last two verses are somewhat of an enigma. The use of the plural pronoun "we" in v. 24 seems to imply someone else other than John the apostle and writer. Yet v. 25 reverts back to the singular "I." A comparison with the epistle of John's, I John, reveals a similar usage of pronouns in ch. 1 and ch. 2. Whether this was John's custom in writing is debatable. There is somewhat of a problem anyway in the attempt to write in third person as is the case in the Gospel. We may simply have the testimony of others to John's integrity in v. 24, while the rest of the book is John's.

The statement in v. 25 about the things which could be written, which would inundate the world, may be thought exaggerated. It is often considered a hyperbole for the sake of emphasis. Yet to write all the things about Jesus' life and teaching, with the application to life, might well be a mammoth undertaking, especially so if one attempted to adequately describe the basis upon which such saying and doings were founded: the Incarnate Word.

Galilee—Matt. 28:16-20

Matthew 28:16-20 records another appearance of Jesus in Galilee, probably the one Paul mentions in I Cor. 15:6.

FORTY DAYS AFTER THE RESURRECTION

Many were convinced of the resurrection of Jesus, and that even to the cost of their well-being and/or earthly existence, Acts 4, 5, 6-7. Others then, as now, were not so convinced and wondered. Matthew does not say whether or not the group to whom Jesus appeared had both believers and doubters in it, or this was just a general description of the people then living. We assume the latter to be true.

The assertion of Jesus in v. 18 is of great importance: it provides the necessary foundation for obedience of His commands. Authority gave Jesus the right to command men to go, to preach, to immerse, to teach—as well as to expect the promise He made to be kept. Yet to say that Jesus did not have this authority prior to the resurrection is a doubtful assertion. No text so says. Conversely, His whole ministry hinges upon such authority, and runs the gamut from authority expressed in the physical realm to the material realm to the spiritual realm. No area of life is left untouched by Jesus' authority. We are inclined to think that He is simply asserting what had always been true, and after the resurrection was convincingly so, that He was deity in the flesh.

This commissioning of the disciples then present is interesting in another aspect: the possibility that more than the eleven were present to hear and receive it. The commission in Luke 24:44-53; John 20:19-23 and Acts 1:1-11 was given only to the eleven men who had accompanied Jesus. However, this one may well have included more than these eleven. The early church understood the general imperatives to go, to preach, to immerse and to teach as inclusive of all disciples anytime—and so they went. Obviously they were correct in their understanding. The church would have died out in one generation otherwise, if only the 12 apostles and those specially chosen by Jesus were to do the evangelizing. Christianity was meant to be a missionary (this word does not occur in the Bible,

however) religion, one that was to be militant and aggressive. Jesus expected results, though having no money, army, state, schools, prestige or degrees. The good news was backed by *the power of God* and that was quite sufficient. Anything and everything could be utilized in making people learners, as long as the ones doing so recognized the power was from God and not within themselves, I Cor. 1:18-2:5. People were not to be coerced but convinced, not compelled but convicted. The disciple was to be one who loved people for what they are: ones for whom Christ died.

The commission here written down has some marvelous ideas in it: such as the three personalities of the Godhead, the idea of evangelism, the work of the disciple: discipling others, the all-encompassing salvation offered: everybody can be saved, the ethics of Christ, His companionship, and His second coming. Someone as suggested the text contains the ideas of a great purpose, plan, power and presence.

The imperatives given are four in number, and each is to be seen as binding upon every disciple. The promise of Jesus' presence is contingent upon the obedience to the commands.

The text is quite correctly translated by the King James, Am. Standard, R.S.V. and N.A.S. The "going," "baptizing" and "teaching" are as mandatory as in the "make disciples." The lack of backbone in these versions (as in others) to translate the Greek term *baptizō* as "immerse" rather than "baptize" is as contemptable as the rest is commendable. The Greek term meant then and still does "plunge under" or "encompass" an object with another substance, literally or figuratively. Had Jesus wanted to command the use of water without specifying the mode, He could have done so. If He wanted to use a word meaning either sprinkle or pour, He could have done so (see John 2:15 and Heb. 9:19 as examples of the last two Greek terms). There is no good excuse for culpableness in this

FORTY DAYS AFTER THE RESURRECTION

regard. The unwillingness to translate properly the Greek term dates all the way back to Tyndale's English translation in 1525, but basically stems from the practice of the Roman Catholic church centuries before Tyndale. Hence, religious error has stayed with us for centuries in this respect.

Some may be also interested in the words used by Christ carrying the ideas of "go," etc. The Greek text for these four words reads as follows in English transliteration (remember: transliteration is *not* translation, by any means): poreuthentes . . . mathēteusate . . . baptizontes . . . didaskontes. The first, third and fourth words are participles, the second an imperative form. However, none are optional. Participles are not optional thus used. Jesus did not intend for the "going" to be optional, anymore than the "immersing" or "teaching" was to be. The N.T. used participles as coordinate with verbs in several places (Greek grammarians label them as "attendant circumstantial" but the participle has equal force with the verb). The Greek language had this idiomatic way of using a participle and a verb, normally in that order, to express two equal and/or imperative ideas. Consider Mt. 20:8; Mk. 6:11; Lk. 19:6; Acts 10:13; 22:16 in this light. The Greek student will know that infinitives and participles are both used for the giving of commands, as in Rom. 12:9ff. The expression in v. 20 "to observe" as a present infinitive "tērein" meaning a constant observance of Jesus' commands.

One popular song carries the idea of never being lonely again since Jesus has been found. This passage so well reiterates for every disciple what Christ promised to the apostles in Jn. 14:18, "I will not leave you orphans."

Luke 24:44-53 brings us to the last appearance of Jesus to His apostles. Luke takes up the thread of thought in his second book, Acts, and goes on with the record in that book, a record of obedience to the commands from Jesus.

We turn our attention just now to the final words to the eleven men, given somewhere close to Bethany.

That a problem exists in the text of Luke is evident, but a decisive solution is not available. The problem is this: Jesus appears to the assembled group on Sunday evening of the day of resurrection. He finally convinces those present that He is the same person that was crucified on Friday previous. This account takes us to v. 43. The verses from 44-53 seemingly present Jesus' last instructions and His ascension some 40 days later than the activity up to v. 43. Perhaps the discussion in the room in Jerusalem on the first resurrection day continues until v. 49, with vv. 50-53 describing the events 40 days later. As stated, no definite decision can be made, and we chose to place vv. 44-49 on the last day of Jesus' life on this earth.

This is the third commission given to the disciples, and if not the same as the one in Acts ch. 1, Jesus gave four separate charges to His followers: John 20; Matt. 28; Luke 24 and Acts 1.

The text of v. 44 is interesting in regard to the three-fold division of the Jewish O.T. The Jews divided their Bible somewhat differently than we do. Their division was that of 1) law, 2) prophets and 3) writings. The division was changed somewhat in the Greek version of the O.T. called the Septuagint. This version was made around 275 B.C. It made a four-fold division (law, history, poetry, prophecy) which was carried over into the Latin Vulgate of Jerome, A.D. 385-405, and into our English Bibles.

The Hebrew Bible probably was first divided into two divisions: law and prophets. This became a three-fold division which still exists in Hebrew Bibles today. The first division called "law" was also referred to as "Moses," since he authored the books so designated. The third division called "writings" was referred to as "Psalms," since this book headed the list, and was the largest of those so desig-

FORTY DAYS AFTER THE RESURRECTION

nated. The three divisions and the books included is as follows:

<i>Law</i>	<i>Prophets</i>	<i>Writings</i>
<ol style="list-style-type: none"> 1. Genesis 2. Exodus 3. Leviticus 4. Numbers 5. Deuteronomy 	<ol style="list-style-type: none"> 1. Former Prophets <ol style="list-style-type: none"> a. Joshua b. Judges c. Samuel (I & II) d. Kings (I & II) 2. Latter Prophets <ol style="list-style-type: none"> a. Isaiah b. Jeremiah c. Ezekiel d. Hosea e. Joel f. Amos g. Obadiah h. Jonah i. Micah j. Nahum k. Habakkuk l. Zephaniah m. Haggai n. Zechariah o. Malachi 	<ol style="list-style-type: none"> 1. Poetical Books <ol style="list-style-type: none"> a. Psalms b. Proverbs c. Job 2. Five Rolls <ol style="list-style-type: none"> a. Song of Songs b. Ruth c. Lamentations d. Esther e. Ecclesiastes 3. Historical Books <ol style="list-style-type: none"> a. Daniel b. Ezra-Nehemiah c. Chronicles (I & II)

The expression in v. 45, "He opened their minds" (R.S.V.) is akin to that of Acts 16:14 about Lydia. The identical Greek word is found in Luke 24:31 referring to the eyes of the two disciples. The puzzler: was the mind of all supernaturally opened, or not? Could this have simply been a description of the effect of Jesus' teaching? Have you never exclaimed, after someone explained something to you, "Oh, I see!"? As before remarked, the key to understanding the O.T. was suffering Messiah (Christ).

NEW TESTAMENT HISTORY: THE CHRIST

Given this key for interpretation, things readily fell into place that heretofore had escaped the disciples' understanding.

A change of mind and a change of state were the basis of the message the men were to preach, and this proclamation was by the authority of the Father, Son and Holy Spirit. To do something in the name of someone is to do it by their authority, as in Acts 3:6; 16:18; 19:13. Some make the statement of Peter in Acts 4:12 to say that one is to be saved in the name of Jesus only, not that of God or the Holy Spirit. Such arguments are rather specious at best, and without foundation at worst. The disciples did not disobey Jesus in what He commanded, Mt. 28:18-20, nor can the three personalities in the Godhead be separated in such a way, as Mt. 10:40; Lk. 10:16; Jn. 12:44-50 and I John 2:22-23 clearly show.

The authority was given, the command issued, and with the coming of the Holy Spirit only 10 days hence, the new covenant was all but proclaimed. The word translated "clothed" (K.J. "endued") is one that means "get into" or "enter in" as a person putting on clothing. (See Mark 1:6; Lk. 8:27; II Cor. 5:3). The men then would preach to a world sitting in "darkness and the shadow of death" (N.A.S.) the way of peace and the good pleasure of God unto each one. All who would see with their eyes and hear with their ears would be saved from the power of sin and the grasp of that old deceiver, Satan, translated out of the devil's kingdom of darkness to God's kingdom of light, Acts 26:18; II Pet. 1:1-4. May the God of all grace help each of us who read this book to proclaim the same good news, that accepted saves us and keeps us saved as long as we keep believing it: "You (Jesus) are the Christ (Messiah), the Son of the living God."

NOTES — QUESTIONS

No. 1-6

John 1:1-18

John

- v. 1 The Greek text is indefinite, any beginning man considers, the Incarnate Word existed.
- v. 2 John attempts to convey the idea that deity has always existed, and the Word is deity. The nature of deity is to be eternal. The Greek preposition rendered "with" is found in I Cor. 13:12 with the idea of "face to face." Hence, the Word was face to face with God, thus God's equal.
- Word*—not a unit composed of letters necessarily, but rather a concept, speech, account, etc. See Matt. 5:32 (ground); Lk. 16:3 (account); Acts 8:21 (matter); I Tim. 5:17 (word, ie. preaching); Heb. 4:13 (account).
- v. 3 Obviously, this verse excludes Jesus from being "made." As deity, He was not made, but always existed; a cause, not an effect. See Col. 1:15-17; Heb. 1:2.
- v. 4 See 5:21-26.
- v. 5 Note the present tense: "shines." All the time is meant. I John 2:8 has the same thought. The Greek term translated "overcome" (apprehend or comprehend) is *katalambanō*. It may mean either understand or overcome. Cf. 12:35; Mk. 9:18; Rom. 9:30; I Cor. 9:24; I Thess. 5:4.
- v. 6 No qualifications as to who John is. The Synoptics would identify the man as the "Immerser." Hence we suppose that the apostle John is the writer of the book.

John came: a definite event in history, even as

- Jesus came, also a definite event in history. Cf. v. 14; Gal. 4:4.
- v. 7 John's Gospel has the idea of witness over 40 times.
- v. 8 John is just "one of the boys," an instrument, a burning lamp for a "season," 5:35.
- v. 9 The real, actual light came. Not the shadow, but the substance, Heb. 1:3. The probable punctuation and translation should be: *The true light, that enlightens every man, was coming into the world.* However, the Greek text is indefinite, and the interpretation expressed in translation has to be decided on other grounds (texts).
- v. 11 The Greek text is more definite than most English translations. Jesus came to His own "things," but among those things were His people the Jews, who did not accept Him, as a people.
- v. 12 The right and ability to choose: that is what God gave to all. Thus the imperative for proclamation of the Gospel to every person.
- v. 13 Cf. John 3:6. Man can not lift himself by his own "bootstraps," at least in respect to salvation. God must intervene.
- v. 14 Cf. II Cor. 8:9; Phil. 2:5ff. The Greek word has the same root consonants as the Hebrew word for Shekinah, which described God's presence. It may simply be a coincidence. Read I John 2:23; 4:2-3; Deut. 4:28; Psalms 115:3-8; Hab. 2:18-20; I Thess. 1:9-10. The Greek term monogenēs means unique, or only one of its kind. See the idea in Lk. 7:12; 8:42; 9:38; Heb. 11:17. The idea of "begotten" is not in the word at all, and is misleading, v. 3.
- v. 15 "My successor is my predecessor."
- v. 16 The Greek term for "grace" may also mean gratitude. The Greek preposition appearing as "upon"

30 YEARS PREPARATION

may quite rightly be understood as "in exchange for." Christ's fullness is available for all.

- v. 17 Grace, not law; truth, not error; salvation in reality, Rom. 8:3.
- v. 18 Consider Deut. 4:12; Ex. 33:20; Col. 1:15; I Tim. 1:17; 6:16; yet read John 14:7, 9.

QUESTIONS

Some of the following questions will expect factual answers, others are for consideration of ideas and concepts in the text. Not all are answered in the commentary by any means, for some are in the Bible.

1. What beginning do you think John had in mind?
2. Why was the statement necessary about "things made?"
3. Is there "life" other than through God? Does life cause itself?
4. Is darkness synonymous with Satan and evil? Note Eph. 6:10ff.
5. Is Jesus equal to "light" and "life" or are these two terms descriptive of Him? Note I John 4:8, 16 for similar syntax.
6. Why is the descriptive adjective "true" applied to the light? Is not every light true or are some lights darkness? Cf. Mt. 6:22-23.
7. What do you understand by the term "enlightens?"
8. Why would you disagree with the idea that the true light (Jesus) enlightens *every man who comes into the world*?
9. Does v. 12 explain who can be enlightened?
10. Do all have the freedom and ability to believe, or are all made believers regardless of their choice in the matter? Cf. 6:44-45.

NEW TESTAMENT HISTORY: THE CHRIST

11. Does this Gospel ever explain how God helps a person to be born?
12. Do you think that Jesus was really human? If so, what reason did He have for becoming so? Read Heb. 4:14-5:10.
13. Have we all received of the grace of Christ? If so, how?
14. Was the law which came through Moses against the truth that Jesus brought? of a shadow, or type of it? Cf. Gal. 3:21-22.
15. How did Jesus reveal deity (you should understand that the word "God" means the quality of deity as well as sometimes designating the personality known to us as God the Father)?

Luke 1:1-4

You should notice the introductions in the back of the book for additional comments on this particular section. The translation of King James "having perfect understanding" should be understood to say "following all things closely/accurately."

Luke

- v. 1 Luke knows of many accounts, but does not say he used any of them.
- v. 2 Luke is a first generation listener, and his sources are eye-witnesses and ministers of the word.
minister translates a Greek word found in Mt. 5:25; Mk. 14:54; Lk. 4:20; Acts 13:5; I Cor. 4:1; all with the idea of servant, helper.
- v. 4 The Greek word translated truth means security or safety. It comes from a word meaning "to slip" or "to fall," and with a prefix means unable to slip or fall, so solid, sure. Luke wants Theophilus to "rest easy" about the person and work of Jesus.

QUESTIONS

16. If others were writing about Jesus, why another account by Luke?
17. How would Luke ascertain the truth about Jesus?
18. Was Theophilus anyone important?
19. Why did Luke address the book of Acts to this same person?
20. What do you know about Luke?

Luke 1:5-17

Luke

- v. 6 Walking in all the commandments and ordinances of the Lord without blame probably explains "righteous."
- v. 7 Righteousness, right lineage, frequent prayers: none avail if God does not wish to bless in the way we think He should.
- v. 8 Cf. I Chron. 24:3-19.
- v. 10 The people were praying—but such was only commanded at the offering of the first-fruits. However, prayer is always good.
- v. 11 The angel is introduced into the story without any explanation as if nothing out of the ordinary. Zechariah is probably facing west, looking at the altar of incense which was before the veil dividing the Holy Place from the Holy of Holies.
- v. 13 The name "John" means "God is gracious."
- v. 14 *Many will rejoice*—but not all?
- v. 15 The Nazirite was to subjugate the flesh and en-thrown the spirit. The Nazirite (also spelled Nazarite) could be either man or woman. The term comes from a Hebrew word (nazar) meaning to "separate," "hold aloof." See Num. 6:1-21. The Nazirite was expected to live a fairly normal

life, the burial of the dead being excepted from his activities. See Judges 13:2-7.

- v. 17 The last and the first: the last herald of God before the law passed into history, the first of the ones to preach that the kingdom of God was at hand.

QUESTIONS

21. Why do you think God waited so long to bless Elizabeth with a child? Did it have anything to do with Mary and Joseph?
22. How old was Elizabeth?
23. Which direction was the angel from Zechariah: south or north (it may depend on what the expression "right side" means)?
24. How many hours of incense were there? Was the hour of incense equal to the hour of prayer (Acts 3)?
25. Of what did John's greatness consist?
26. What did John have to say for himself? (Cf. Mt. 3, Jn. 1). What did Jesus say about John? (Cf. Mt. 11, Lk. 7.)

Luke 1:18-25

Luke

- v. 18 Zechariah was like Sarah in Gen. 18, unlike Mary in Lk. 1.
- v. 20 Unbelief is always wrong, and always punished.
- v. 23 *service* (Greek leitourgias) common word for any public service.
- v. 24 *conceived*: a cause for rejoicing, v. 41ff., because God's apparent displeasure had been removed.

QUESTIONS

27. How was Zechariah's response different than Mary's?

30 YEARS PREPARATION

28. How would the people know Zechariah had seen a vision? Was such common?
29. How long was Zechariah's time of service?
30. Why do you think Elizabeth hid herself?

Matt. 1:18-25; Luke 1:26-38

These two texts are placed together for your study. They may not be parallel in some ways.

Matt.

- v. 18 *betrothed*: almost equal to marriage, the betrothal period was often for a year. Note the word "wife" in v. 21; Luke 2:5; "husband" in Mt. 1:16; Lk. 1:34.
- v. 19 Problem: if Joseph would not believe Mary, who would believe either of them?
quietly: Joseph could have had Mary stoned to death.
- v. 22 Isaiah had so written in 7:14.
- v. 24 Imagine the relief Mary had when Joseph went ahead with the marriage plans!
- v. 25 *knew* is a common synonym for sexual intercourse. Nothing is wrong with such in marriage—it is God's plan for husband and wife! Anything else is abnormal.

Luke

- v. 26 The text only states that Elizabeth was 6 months pregnant, not that Mary became pregnant at this time.
- v. 29 *considered*: the Greek word means "to reckon up" or "calculate" as in Matt. 21:25; Mk. 2:6; Rom. 4:8; Heb. 11:19.
- v. 32 Note the question of Caiaphas in Mk. 14:61.
- v. 33 *no end*: of course not—God is eternal.

- v. 34 Mary wanted to know how God planned to do the birth.
- v. 36 *kinswoman*: related in some way, but not explicitly stated, cf. v. 58; 2:44.
- v. 37 God's power is expressed in many ways, but all in accord with His perfect righteousness.

QUESTIONS

31. Why the two accounts by Matthew and Luke in regard to Joseph and Mary respectively?
32. Why do you suppose the angel Gabriel was sent to Mary, not to Joseph? (He appeared to Joseph in a dream—if the angel was Gabriel.)
33. Did Joseph's justness exclude his mercy?
34. Why did Joseph plan to put Mary away—they were not "together" yet, were they?
35. How would Joseph know who the Holy Spirit was?
36. When Joseph obeyed the angel, what did he do?
37. Joseph was directed to call the son "Jesus." What did the prophecy say the child's name would be?
38. Is the word "wife" in v. 24 proleptic (i.e., anticipating the marriage ceremony)?
39. Does Luke's account ever say when Mary was to become pregnant?
40. Why could not God send Christ as a grown man instead of going through such a process? Did God not know the problems that Mary, Joseph, Jesus, the family, etc. would face from the neighbors, etc.?
41. Who is the house of Jacob?
42. Did God promise David such a son? See II Sam. 7:4-17.
43. How can the word "son" be understood? David has been dead a millennium. See Matt. 1:1; Rom. 4:16; Gal. 3:29.

30 YEARS PREPARATION

Luke 1:39-45

Luke

- v. 39 *hill country*: probably south of Jerusalem and Hebron.
- v. 41 At six months, movement of a baby within the womb is not uncommon. But Elizabeth knew why!
- v. 43 Notice that Elizabeth is not jealous of Mary. Did she not expect a "kinswoman" to visit her? or did no one know of her pregnancy?

QUESTIONS

44. Does the text seemingly imply that Mary had not known of Elizabeth's pregnancy? or that she should now go share with Elizabeth?
45. How many supernatural births can you find in the Bible?
46. How does Elizabeth know of Mary's child and its nature?

Luke 1:46-56

Luke

- v. 46 Note that Mary uses "soul" in v. 46, "spirit" in v. 47.
- v. 47 *God . . . savior*: may mean God the Father, or that salvation is from deity, not humanity.
- v. 48 call Mary blessed, but not savior! See Psalms 136:23.
- v. 50 Note that mercy is only for those who fear God as He deserves to be feared. God's promises are conditional.
- v. 51 See Ex. 15:6; Ps. 98:1; 136:12; Isa. 51:9-10.
- v. 52f. God, the great leveler! Note this in reference to Matt. 5:3-12. Consider that Mary mentions God's power, holiness, mercy and faithfulness.

QUESTIONS

47. How many songs or exclamations of praise does Luke record?
48. Are soul and spirit synonymous?
49. Does God always keep His promises?
50. Did Mary stay until John was born?

Luke 1:57-66

Luke

- v. 57 God keeps promises!
- v. 58 cf. v. 14
- v. 59 Note that circumcision took place regardless of what day it was. See Jn. 7:22-24. Read Ch. 3 of *None of These Diseases* by McMillen.
- v. 65 Note this response throughout the neighborhood. It will not be long until shepherds will tell a marvelous story too, perhaps to the same neighborhood.

QUESTIONS

51. Why did the neighbors think God had shown "great mercy" to Elizabeth?
52. Why circumcise the boy the eighth day?
53. Why the opposition to the name of John?
54. Why would people have the "make signs" to Zechariah? Was he also unable to hear?
55. How does one "bless God?" Do vv. 67-79 express this blessing?

Luke 1:67-80

Luke

- v. 67 Note that Luke does not say when Zechariah uttered this which is recorded.
- v. 68 Zechariah talks of Jesus, for whom his son was to be the forerunner in vv. 68-75, and about his son

30 YEARS' PREPARATION

- in v. 76. It is somewhat difficult to determine whether vv. 77-79 are spoken about John or Jesus, though Jesus is mentioned.
- v. 69 Horn of salvation: horn often used in the O.T. to mean power, as in II Sam. 22:3; Ps. 132:17; Dan. 7:8; etc. Note Zechariah's knowledge about Jesus' lineage, etc.
- v. 71f. Note how Zechariah knows the power and promises of God in the O.T.
- v. 73 without fear: probably of enemies, not without fear of God. See Lk. 12:5ff., I Jn. 4:18.
- v. 77 *salvation*: not in a political sense, however Zechariah might have understood it.
- v. 78f. See Matt. 4:14; Lk. 22:53; Jn. 1:5; 3:19-21.
- v. 80 Each boy developing as God ordained. Notice how inspiration only reveals the essentials, not the mundane.

QUESTIONS

56. How many people are said to be "filled with the Holy Spirit" in this chapter?
57. Is this filling of the Holy Spirit any different than that such as in Acts 4:31 or Eph. 5:18? If so, how?
58. How do you think Zechariah thought Jesus would deliver the Israelites from their "enemies?"
59. Is knowledge of salvation directly related to "forgiveness of sins?" That is, does the one involve the other? Cf. Mk. 1:4.
60. How does one sit in the "shadow of death?" Note Eph. 2:1.
61. Where was the wilderness of John's youth?

7. Bethlehem—Luke 2:1-20

Read the introduction to Luke's Gospel for some dis-

cussion on 2:1-5, and the short discussion of Quirinius (Cyrenius) and the census.

Luke

- v. 2 Luke mentions a different enrollment in Acts 5, and has Gamaliel remark about the trouble during that time. The Jews hated the Romans, and the census every 14 years only aggravated the relationship.
- v. 4 There were two Bethlehems, one in Galilee, one in Judea. This Bethlehem was some six miles south of Jerusalem, located in somewhat hilly country.
- v. 6 No one knows whether these were temple shepherds, or just shepherds who were watching their flocks. We do not know that the flock was not in a fold rather than out on a hillside. We surely do not know what kind of sheep they were keeping, contrary to what some say.
- v. 11 Jerusalem was sometimes called the city of David too, (I Kings 2:10; II Chron. 32:30) but Bethlehem was the one the angels meant.
- v. 13 The text does not say the angels sang, though praise may be expressed this way.
- v. 14 The text is unsure in regard to the word translated as "well-pleased." Only one letter makes the difference between the translation in King James (among men of good will) and R.S.V., well-pleased. The greater probability, both textually and Bible context as a whole is "well-pleased." The forms are eudokia (text for K.J.) and eudokias earlier Greek texts.)
- v. 15 The Greek text indicates great excitement on the part of the shepherds. They "kept saying" to one another, "Let's go (now) and see this thing." The Greek which translated "thing" is hrēma, (this) "word" which has happened.

30 YEARS PREPARATION

- v. 17 The second supernatural event to occur in this region in a short period of time.
- v. 19 First the angel to her, and then to Joseph, then the realization she was going to have a child as God said, Elizabeth's pregnancy and Zechariah's condition, then the actual birth in a stable, no less, (did she know about the prophecy in regard to Bethlehem?), then the shepherds with their story; soon the expressions of Simeon and Anna in the temple at Jerusalem, then the visit of the wise men, the expression of Jesus at the age of 12 to her—she had much to ponder!

QUESTIONS

62. What do you know about Quirinius?
63. Were swaddling cloths the usual clothing for infants?
64. Does the text say what time of year it was?
65. What did the angel's words "savior, . . . Christ (Messiah) . . . Lord," mean to the shepherds?
66. Why should the angels praise God—they did not need a savior did they? Cf. I Peter 1:10-12.
67. What was the sign for the shepherds: a babe in swaddling cloths, or a babe in a manger?
68. Do you think the shepherds left the sheep unattended, in a sheep-fold, or what?

8. Jerusalem—Luke 2:21-38

Luke

- v. 21 Abraham received the command to circumcise all males, and all Jewish males were to be circumcised that they might be an "official" Israelite. See Gen. 17:9-14.
- v. 22 The first-born male, whether animal or man, was

- God's. However, the male could be bought back, Ex. 13:2, 11-16; 22:29-30; Num. 18:15-20.
- v. 24 See Lev. 12 for laws about purification after childbirth. Note their poor circumstances, since they did not offer the stipulated offering, but a substitute.
- v. 25 The Greek word translated "consolation" is *paraklēsan*, "the one to take Israel's part." Note though vv. 31-32 "all peoples." Cf. Isa. 40:1; I Jn. 2:1.
- v. 27 40 days after birth of boy.
- v. 29 *peace*: not outwardly, necessarily, but inwardly. See Rom. 5:1; II Tim. 3:12.
- v. 30 See Peter's remarks in Acts 3:17-26.
- v. 33 Perhaps Joseph and Mary still did not adequately understand what God was doing for them—they marvelled.
- v. 34 See Rom. 9:33.
- v. 35 The thoughts of men were revealed in the ministry of Jesus: as of Peter, Nicodemus, Pharisees, Sadducees, Caiaphas, Pilate, Herod, chief priests, Roman centurion, etc.
- v. 36 It is hard to decide just what Luke meant about Anna—if her marriage lasted 7 years, or if she married at 7 years old, or if her widowhood had been for a total of 84 years, or if she were 84 years old.
- v. 38 *redemption*: an obvious need for all, despite the law.

QUESTIONS

69. Joseph and Mary offered the "poor" offering. Do you suppose that Jesus grew up in a home that had difficulty making "ends meet?"
70. What relationship does the Holy Spirit sustain with God? See Jn. 16:7-14 and Gen. 1:2.

30 YEARS PREPARATION

71. Did the Holy Spirit also reveal to Simeon how he would recognize the Messiah?
72. Do you think Simeon (and Zechariah, Elizabeth and Mary) really understood the nature (universal, all-inclusive) of the Messiah's kingdom?
73. Did Anna never leave the temple grounds?
74. Who is the "him" of whom Anna spoke?

9. Bethlehem—Matt. 2:1-12

Matt.

- v. 1 The text does not say when Jesus was born, nor how long after His birth the wise men came, nor how many wise men there were. Neither does it say how the wise men knew. Num. 24:17 is far too enigmatic to figure out what they very apparently knew. We can figure it out with our "hindsight" but they did not have what we have. The text in Gen. 3:15 is of the same nature as Num. 24:17 in that we interpret it in light of the rest of the Bible. *wise men* (Greek magi, as in Acts 13:6, 8).
- v. 2 Note that the wise men do not say when the star appeared, of what nature it was, nor where it was. They were in the East but the star could have been any direction from them. Nor do they say the star led them to Jerusalem, only that it appeared. The men were probably Gentiles, so the prophecy of Simon is already coming to pass.
- v. 4 Herod's father was an Idumean (Edom) and his mother an Arab.
- v. 5 See Micah 5:2.
- v. 9 Note that the star led them to the exact place where Jesus was. The text probably indicates they had not seen the star since it first appeared to them.

- v. 11 The Greek word for "child" means one several weeks old, or older.
- v. 12 The Greek text from which the King James version was translated had the words "of God" in this text. The dream probably was from God, but the more probable textual reading does not have the words "of God."

QUESTIONS

75. Which Herod is king now (the N.T. mentions 5 different ones)?
76. The wise men did not say that the baby born was the *Messiah*, but that the child born was *king*. Why did Herod ask about the Messiah rather than the king?
77. Why would Herod secretly interview the wise men to ask them about the appearance of the star?
78. Where did the wise men find Joseph, Mary and Jesus?

10. Egypt—Matt. 2:13-18

11. Nazareth—Matt. 2:19-23

Matt.

- v. 13 Very likely, the appearance of the angel to Joseph was the same night as the day on which the wise men left.
- v. 15 By reading Hosea 11:1, you could never tell that the verse was to be prophetic, since it is an historical statement in the prophet. Hence, inspiration from God through the pen of Matthew tells us the verse was prophetic.
- v. 16 So Herod knew about how old Jesus was, and doubtless made sure the two year-old limit would be adequate.
- v. 18 Jer. 31:15.

30 YEARS PREPARATION

- v. 22 Archelaus was one of Herod's three sons who shared his kingdom. Archelaus ruled Judea, Samaria and Idumea. Herod Antipas (the "fox") ruled Galilee and Perea. Philip ruled Iturea, Trachonitis and some other districts in the north east. Archelaus immediately had trouble with the Jews, and after 10 years rule, the Jews got him deposed. He was banished to Gaul. Judea then was ruled by Roman governors like Pilate.
- v. 23 The Old Testament does not have any verse which says Jesus was to be called a Nazarene. The word Nazareth does not occur in the O.T. Perhaps this is a summary of what the prophets taught rather than a direct quote.

12. Nazareth—(Matt. 2:23), Luke 2:38-40

Luke

- v. 39 Note that Luke's account does not deny the events in Matt. 2, but simply records that the family went back to Nazareth, which Matthew also states. Neither denies the other.
- v. 40 A perfect man, developing perfectly. The brevity of the accounts simply indicates that the writers are giving a history of selected events, not a biography as we use the term. The inspiration of the writers by the Holy Spirit assured 1) that the history would be true as written, and 2) that the conclusions drawn (or interpretations given) would be what God wanted.

QUESTIONS

79. What was performed according to God's law?

13. Jerusalem—Luke 2:40-52

Luke

- v. 41 The men were required to attend three feasts yearly, Passover, Pentecost and Tabernacles. See Ex. 23:14-17; Deut. 16:16-17. The women could go if they chose. The Jewish boy became a "son of the law" at age 12.
- v. 42 So Jesus went to become obligated to the law, though intending to replace it.
- v. 44 A day's journey probably down to the vicinity of Jericho.
- v. 45 A day's journey back (total 2 days).
- v. 46 The third day, after some searching, they found Jesus in the temple.
- v. 47 Note Jn. 7:45-46; Col. 2:3.
- v. 49 The Greek text here is indefinite about what Jesus must be. It reads as follows: *ouk eideite hoti en tois tou patros mou dei einai mē?* The words in question are *en tois*. These could refer to many things, but there is no antecedent for them. It may mean "the things of My Father" which would include God's business (K.J.) or house (R.S.V.), etc.
- v. 51 Cf. Heb. 5:9. Jesus kept the law, obeying the "first command with promise."
- v. 52 *Wisdom*, *sophia*. *Stature*, *hēlikiai*, as in Matt. 6:27. *Favor*, *chariti*, as in Jn. 1:16.

QUESTIONS

80. How many total days elapsed before Jesus was found?
81. Is there any difference between asking "deep" questions and giving evidence of "deep" understanding and answers? Which did Jesus do?
82. This is the only recorded incident in some 30 years

30 YEARS PREPARATION

of Jesus' life, from infancy to preaching ministry. Why do you suppose God did not tell us more about this part of Jesus' life?

14. Jordan River—Matt. 3:1-10; Mk. 1-18; Lk. 3:1-20

This section is not specifically mentioned in the harmony outline, but it is worthy of some study.

Matt.

- v. 1 Luke specifically identifies the indefinite time of Matthew, 3:1-2.
- v. 2 Note that John was preparing the way for the *Lord*, and preaching that the kingdom was upon them.
- v. 3 The Gospels never present Jesus as just a man, but a divine/human personality.
- v. 4 Many people eat varieties of locusts and consider them delicious in our time even as in John's day.
- v. 7 John did not necessarily condemn all Pharisees and Sadducees, but some of them certainly felt his wrath. See Matt. 23:33.
- v. 8 The fruit of repentance: a changed life, subservient to God's will in thought and deeds, inwardly and outwardly.
- v. 9 Family lineage of no effect if God's will is not done.
- v. 10 What vivid word pictures!
- v. 11 Note what John implies about the deity of Jesus! It is not said by John that the same persons (or all people) will receive the immersion of the Holy Spirit and fire—only that Jesus would provide such. See Lk. 24:49 and Acts 1:1-8 for the specific people (the apostles) to be immersed in the Holy Spirit. Those to be immersed in fire are found in Rev. 20:11-15.

NEW TESTAMENT HISTORY: THE CHRIST

v. 14 Note the ideas in antithesis—John/Jesus, then Holy Spirit/fire, wheat/chaff, granary/fire.

A clean sweep—some for life, some for judgment, Jn. 5:28-29.

Mark

v. 1 Note Mark's affirmation of deity for Jesus.

v. 2 Isaiah 40:3-4; see also Mal. 3:1, 4:5-6.

v. 4 John's immersion was for forgiveness of sins. The Greek text reads like Matt. 26:28. For comparison:

Matt. 26:28 eis aphēsin hamartiōn

Mk. 1:4 eis aphēsin hamartiōn

No one questions that Jesus' blood was shed for the remission of sins. The people who came to hear John's preaching, and to accept the message as from God (faith), made up their minds to do what John preached (repentance). The result was immersion in water. Hence, faith, repentance and immersion brought forgiveness of sins. See Matt. 21:25; Lk. 7:29-30. Some people today are as obstinate about immersion as people of John's day and for the same reason: unbelief.

Luke

v. 1 Tiberius was a step-son of Augustus Ceasar. His full name was Tiberius Julius Ceasar Augustus. He became emperor in A.D. 14, succeeding his step-father. His mother was Livia, wife of Augustus, but his father was Tiberius Claudias Nero, her first husband. Tiberius died in A.D. 37.

Pontius Pilate became governor of Judea and Samaria in A.D. 26 and was governor until A.D. 36.

v. 2 Annas was high priest by Jewish law. But the Roman government had deposed him. However, he managed to get some of his relatives appointed to

30 YEARS PREPARATION

the office and he remained the "power" behind the office. Caiaphas was his son-in-law.

The Word of God was apparently the message of John preached.

- v. 9 Notice that *fruit* (our choices expressed in our life) determines destiny.
- v. 11 People can not ignore the needs of others. Yet religion can digress as far into social concerns as it does into monasteries.
- v. 12 Read Matt. 21:31-32; 23:13; Lk. 11:52. Matthew was a tax-collector.
- v. 14 No "shake-downs" nor intimidations. Might does not make right. Yet no command to get out of the army. John says: Do your job well.
- v. 16 "With" translates a Greek preposition that often can be understood as "by means of," or "in area of."
- v. 18 Good news! The Gospel has begun to fall upon the ears of men.

You may want to place vv. 19-20 with Matt. 4:12 and Mk. 1:14. Luke does not say when John was arrested, just records who arrested him and why.

QUESTIONS

- 83. In Matthew's account, how does he describe John's food and clothing as compared to Mark and Luke?
- 84. Which account explains the other: Matt. v. 7 or Lk. v. 7? Or is it both/and?
- 85. Why the expression "unquenchable?" Does it mean it will never go out or that man can not put it out?
- 86. Does Mark's account omit much of Jesus' life prior to the time of ministry?
- 87. Because Mark and John do not mention Jesus' birth,

does that mean that the writers did not know about it (i.e. the details)? or that it was unimportant?

88. Does Lk. 3:1-2 show an historian's touch?
89. Is the fruit John mentions in v. 8 the kind of life he mentions in vv. 11, 13, 14? Have you ever heard "fruit" defined as meaning "soul-winning?"
90. Why would people think John was the Christ? because of his appearance? early life? ancestry? preaching? miracles?

John 1:19-28

This also precedes Jesus' baptism, but is important to understanding John's self-knowledge of his position in respect to Jesus.

John

v. 19 John made the "evening news" and the Jerusalem hierarchy was more than a little interested. The Gospel of John probably presupposes knowledge of John, and gives his witness to Jesus.

Priests were chosen from among Levites.

v. 20 One's relationship to Jesus and the ministry in which we participate both demand that we keep in mind "who we are."

v. 21 Elijah was expected, Mal. 4:5-6. Jesus said Elijah came, Matt. 17:9-13.

The prophet—maybe an oblique reference to get some response from John.

v. 22 "For the last time, identify yourself!" Orthodoxy is always insecure with the non-orthodox.

v. 23 All anybody needs to be—a nobody in service of the King.

v. 24 Reminiscent of the question in Matt. 21:23 and Jn. 2:8.

- v. 23 King James reads Bethabara. This reading came from Origen, who could not find a Bethany beyond Jordan. Hence, he advocated the change to Bethabara, which he could find. Poor judgment for an otherwise pretty good scholar. The evidence textually is strongly for Bethany.

Beyond the Jordan is probably east of the Jordan.

QUESTIONS

91. Is it enough to be "just a voice" in behalf of Jesus?
 92. What was John's comparison of himself in relationship to Christ?

Matt. 3:13-17; Mk. 1:9-11; Lk. 3:21-22

Matt.

- v. 13 Christ was immersed by John, if for no other reason than that it was God's will for every Israelite.
 v. 14 John probably knew who Jesus was, perhaps at first only in a family sense. In view of his supernatural birth, and his parents' knowledge of Jesus' birth, it is rather difficult to conclude that John knew nothing of Jesus.
 v. 15 God's every wish—our command.
 v. 16 All of the personalities in the Godhead are involved in Jesus' baptism. See 3:34.
 v. 17 The perfect response to perfect obedience.

Mark

- v. 9 Some suggest that Jesus may have walked 50 or 60 miles to be immersed. We do not know where Jesus went to find John, however.

Luke

- v. 21 Some take the verse to mean that Jesus was last of a group of people. Others take it that Jesus came after the people had left.

- v. 22 Note that the text only indicates the bodily form in which the Holy Spirit descended was like that of a dove. The comparative "like" may mean many different things: grey, with wings, bird-shaped, two feet, etc.

QUESTIONS

93. Why did John try to get out of immersing Jesus? Was it not God's will that everyone be obedient? Or did John consider that Jesus was God?
94. What constitutes righteousness?
95. Since the sign of which John speaks (Jn. 1:33) had not yet happened, how did John know about Jesus' character?
96. What does Luke add to the account of Jesus' immersion that Matthew and Mark do not?
97. Who saw the Holy Spirit descending? John? Jesus? the people?
98. How can heavens "open?"
99. For whose benefit was the voice? See Jn. 12:28-30.

15. Wilderness—Matt. 4:1-11; Mk. 1:12-13; Lk. 4:1-13

Matt.

- v. 1 Note the varied expressions: "led," "drove," and "full of."
- v. 3 The Greek text is in the form of a supposition if this, then that. Note the fact that the Greek text has no article before the word "son," yet the English translations all have it. See the discussion under # 72 (20).
- v. 4 Deut. 8:3. The first word: authority of God!
- v. 5 No one knows what pinnacle—or where it was in

30 YEARS PREPARATION

the temple. The temptations are unique by any standard. The devil surely did not appear in human form and take Jesus to the temple, and together climb up and sit down on some pinnacle?!?

- v. 6 Psalms 91:11-12. God's Word is not the property of humans only!
- v. 7 To trust God is one thing—to test God is quite another. Jesus teaches a good hermeneutical principle: never take a scripture out of the context of the whole of God's Word.
- v. 8 Material things have "glory" just as spiritual things. Perhaps the reason is that all can be utilized for God's glory.
- v. 9 The devil is the prince (ruler) of this world, Jn. 14:30 and the god of this world, II Cor. 4:4. However, he may not have the ability to "give" anything to anyone. Remember: Jesus is being tempted! Perhaps the way out of temptation is to see how *false* Satan's offer is.
- v. 10 To worship God may well mean to ascribe to Him the acclamation that He rules this world, and it is God's world, not Satan's.
- v. 11 No one is tempted without God's knowledge—He always cares for His own. See I Peter 5:10.

Mark

- v. 12 One never serves God in obedience and gets to rest on past performance. Each option to serve God (to be immersed was an option) is but the introduction to another way to serve. To restate: each experience in life is to prepare us for the next experience.
- v. 13 Mark's word *peirazomenos* probably indicates various temptations over a period of time, Matthew and Luke's accounts simply telling of the "major

temptations," perhaps representative of others. No one lives in any vacuum of time.

Luke

- v. 1 Jesus probably was led by the Spirit in various ways. We doubt that He was not "self-controlled" even though under the Spirit's leadership at the same time.
- v. 3 So seemingly "right" to provide for the body's needs. But Jesus did not approach any situation in life without a God-given basis of right and wrong by which to judge. The devil is behind such things as "situation ethics."
- v. 5 In a moment of time and all of the kingdoms. Quite humanly impossible, either to present the kingdoms or to discern their worth, individually and collectively.
- v. 9 Even a holy place can be misused!
- v. 12 Three chances to win—Struck out! Jesus won in this particular game in life by trusting God—so can we!
- v. 13 An opportune time! A word to the wise is sufficient, is it not? See I Cor. 10:12-13; I Peter 5:8-9.

QUESTIONS

- 100. What different kinds of temptations were presented? (I Jn. 2:15-16).
- 101. How many other men in the Bible fasted 40 days?
- 102. Suppose you were Satan: would you attempt to get Jesus to doubt His relationship to God (if . . .)? or would you presume Jesus knew Who He was, and go from there?
- 103. Does the promise in Psalms 91:11-12 apply literally to those who trust in God, if at all? Note that a leap from the pinnacle would hardly be in the

30 YEARS PREPARATION

same category as stumbling over a stone! Or is the text saying that God guards the believer even in the ordinary happenings in life? By the way, have any of God's children ever been mistreated or harmed? Does God not keep His promises?

104. What constitutes "glory" in a material thing?

105. Is temptation a common experience for everyone?

Matt. 1:1-17; Lk. 3:23-38

Genealogies were important to the Hebrew people because they had to do with the laws of inheritance. See Lev. 25; Num. 27, 36. They also had to do with God's promises to certain individuals for certain things, as with Abraham and Isaac (not Ishmael), and Isaac and Jacob (not Esau), with Aaron and the tribe of Levi, or with David and the promise about his sons sitting upon his throne. Note Jesus' question in Matt. 22:41-45; and Paul's statements in Phil. 3:5 and Titus 3:9.

The genealogies show that Jesus was 1) of the proper lineage to fulfill the promise of God to David and Abraham, 2) of man, 3) of God.

There are too many problems with the genealogies to treat in a commentary of this nature. None are without solution, but space in this book is lacking for such discussion. Some brief remarks will have to suffice. We suggest R. C. Foster's syllabus, *The First and Second Years* (available from Ozark Bible College Bookstore, Joplin, Missouri); or Ch. 7, "The Genealogies," pp. 273-276, of his book, *Introduction and Early Ministry*, Baker Book; Fowler's discussion, pp. 11-30, *The Gospel of Matthew*, Vol. I, College Press; or McGarvey's *Evidences of Christianity*, Part III, pp. 51-55, *Gospel Advocate*.

Matthew's list was to show what he asserted in 1:1, that Jesus was from David and Abraham. To the Jewish people, this was of great importance. A parallel would be

in America, where those who aspire to be president must be American citizens.

Matthew then traced the lineage through patriarchs, kings and through the period of the exile to Joseph, and his legal (not natural) son Jesus. Remember that "son" in the Bible may mean 1) natural son, 2) adopted (legal) son, 3) grandson, 4) Levirate son, 5) general descendent, or 6) of like nature or persuasion. The list excludes names, but does not falsify the actual facts, since "son" may be used several different ways. The records were readily available if an error was made. Matthew simply showed how what he asserted in v. 1 was true. The inclusion of women known to Jewish students of history and other additional material made the list "memorable" which is the stated purpose in v. 17. The 42 generations he listed were probably of particular interest and easily used in the three divisions presented.

Luke probably traced the blood line, though some dispute this. The account in chs. 1 & 2 help us see what he meant by the expression about Joseph ("as was supposed") being the father of Jesus. The tracing of the lineage through 76 generations to God is not less interesting than Matthew's account. It shows the genealogies were of common interest in many cultures. The statement "son of" may either apply to Jesus all the way through the list, and/or to the relationships of the two persons thus connected. It is noticeable that the lists only meet once from Joseph to David, and that is in the two men called Zerubbabel and Shealtiel. From Abraham to David, the genealogies are alike. From Adam to Abraham, there is some small differences between Luke's account and the Old Testament records. The 20 generations Luke gives included the men found in the list in Gen. 5 and 10, and included Cainan, not found Gen. 10, nor in I Chron. 1:24, who was the son of Arphaxad.

QUESTIONS

106. How many women does Matthew include in his genealogy?
107. What kind of women were they?
108. Did you ever read I Chron. 1-9? Notice the idea of generations in Gen. 5, 10, 11, 25, 36, 46. Genesis was a book of beginnings, too.

16. Bethany—John 1:29-51

John

- v. 29 Apparently after the interview with the priests and Levites. Jesus has been immersed prior to this moment of speaking.
- v. 31 We wonder if John understood "world" to mean "Jewish world." Whether John means he knew nothing of Jesus, or was unaware of the total truth about Jesus is hard to decide.
- v. 32 John saw the Holy Spirit descend as a dove-like form. We wonder if Jesus saw the same thing, or anyone else—or if it were just for John's benefit alone.
- v. 35 Three days successively, though little is told of the whole day's activities.
The two disciples are probably Andrew and John.
- v. 38 Jesus asks "what" they want. He probably knew—the question was for their benefit.
- v. 39 *Tenth hour*: either 10 a.m. or 4 p.m. The latter is preferred. See Lk. 9:57ff.
- v. 41 Much discussion over the idea of "first"—whether it means before he did anything else, or ahead of the time when the other disciple found Peter is hard to decide. Not terribly important, though.
It certainly was an interesting day for the two disciples and their brothers. Consider the fact that

NEW TESTAMENT HISTORY: THE CHRIST

Jesus, a man, was identified as the Son of God and as the Messiah by these four men.

- v. 42 Though people in those days had more than one name, they did not have last names as we do. They were rather identified as "belonging to" to a person, place or thing, etc. See v. 45.
- v. 43 The fourth day.
Philip is a Greek name. See Jn. 6:5; 12:21.
- v. 45 Eureka! See Jn. 5:39-47.
- v. 46 A personal experience with Jesus is not to be had vicariously.
- v. 47 Guile: from a word meaning deceit, or snare. See Matt. 7:22; 14:1; 26:4; Acts 13:10; II Cor. 12:16; I Thess. 2:13; I Pet. 2:1; 3:10. Nathanael was transparently a real Jew!
- v. 48 The fact that Jesus saw Nathanael under a fig tree meant something to Nathanael, though it is not clear to us what it meant.
- v. 51 Jesus was still beyond complete comprehension at His ascension, though the men would understand Him much better by that time.

QUESTIONS

- 109. What Old Testament type did John apply to the man Jesus?
- 110. Do you think John really thought Jesus was going to die as a sacrifice for sin?
- 111. Why does John translate the Aramaic words? (v. 38, 41, 42)
- 112. Was Philip a friend of Peter and Andrew?
- 113. Were Philip and Nathanael followers of John the Immerser?
- 114. How did the men know Jesus of Nazareth was the one spoken of in the law and prophets?

30 YEARS PREPARATION

115. Do the Gospels ever record the fact Jesus mentions in v. 51?

17. Cana—John 2:1-11

John

v.1 Probably the third day from v. 44. Cana was but a short distance from Nazareth.

v.2 Perhaps the wedding was a family relative or friend. note—Jesus' disciples: Peter, Andrew, James, John, Philip and Nathanael—long before the incident in Matt. 4; Mk. 1; Lk. 5.

v.3 The word for failed is *husterēsantos*, as in Mk. 10:21; Lk. 22:35; Rom. 3:23; I Cor. 12:24; II Cor. 11:5; Phil. 4:12; Heb. 4:1; 12:15.

v.4 A hard thought to translate. See the discussion in the section of comments. However, "woman" is not necessarily unkind at all, but quite appropriate in that culture.

v.5 Whether Mary had something to do with the feast, or was just a friend trying to help is unknown. Remember: a wedding feast might last for a week.

v.6 Water for immersing of hands, etc., Mk. 7:2-4; Lk. 7:44; Jn. 13:5. Some had probably already been used.

v.7 Sounds like an eyewitness account. At least the disciples knew it was a miracle, v. 11, whether anyone else did or not, v. 9.

v.8 Water from the jars—into wine.

v.10 A fact—anything may become less appetizing when one is satiated, whether food, drink, sports, etc.

The steward: "I've never seen it done this way!"

QUESTIONS

116. Why do you think the wine was intoxicating?

117. Is it difficult for mothers and fathers to know when to "let go" of their children?
118. How did Mary know Jesus could do anything about the wine shortage?

18. Capernaum—John 2:12

The text does not state the fact here, but it seemingly implies that the family moved to Capernaum, though Joseph and the sisters are not mentioned. Perhaps it was a visit in the home (Bethsaida was nearby to Capernaum) of Zebedee and Salome, Mary's sister and her husband. Remember too that Peter and Andrew were fishing partners with Zebedee and his sons. Perhaps they went together and furnished Jesus a house in which to live. Capernaum is henceforth the base for the ministry in Galilee. The move, if not permanent now, later became so, Matt. 4:13; Mk. 2:1.

19. Jerusalem—John 2:12-25

The first of four Passovers John mentions. The feast in John 5 is either Passover or Pentecost which makes little difference in the reckoning of the length of Jesus' ministry. John

- v. 13 Note how John, a Jew, uses the word "Jews" in his book. Always in a way indicating the people so designated were far removed from or in opposition to Jesus.
- v. 14 All the items mentioned were needed at Passover time. The temple court just was not the place to have them. It seems from Jesus' speech and actions that the temple hierarchy had made buying and selling into a business of graft.
- v. 15 Jews, especially those from foreign countries, would

FIRST YEAR MINISTRY

need to have Jewish coinage for some temple offerings, such as the half-shekel for the temple tax due at that time.

- v. 16 House of trade—our word emporium (Greek, emporiou).
- v. 17 Psalms 69:9—Perhaps the first time they had seen Jesus in “action.”
- v. 18 The temple authorities had a right to ask. But see Mal. 3:1-3. Jesus was Himself the sign!
- v. 19 See Matt. 26:61; Mk. 14:58—Jesus meant His death and resurrection.
- v. 20 “You?” (Herod had begun it in the 18th year of his reign, about 19 B.C. Hence, it was about A.D. 26.) They took Jesus literally.
- v. 21 John’s understanding from years later.
No one can identify which Scripture John has in mind. It may be Psalms 16:10, or what Jesus said, since His utterance would be “God-breathed,” the qualification for Scripture.
- v. 23 Perhaps Jesus did many other things not recorded. Actually, the cleansing of the temple was not a miracle in the sense in which John used the word “sign.” It was a display of authority.
- v. 24 The Greek word translated here as “trust” is translated elsewhere “faith.” Faith is essentially trust in something and/or someone.
- v. 25 How well Jesus really knew what man was!

QUESTIONS

- 119. What direction did Jesus go to Jerusalem?
- 120. How was the temple court divided (i.e., into what sections, etc.)? Use a Bible dictionary or other source to help find the answer.
- 121. What did Jesus drive out—the men or the cattle?

NEW TESTAMENT HISTORY: THE CHRIST

122. Did he turn the doves and pigeons loose?
123. Why "pour out" all the money? (The Greek word translated "pour" is *cheō* with a prefix. The "ch" is pronounced something like a hard k.)
124. Did the disciples not understand what Jesus said?
125. See Gen. 1:26; Psalms 103:14-16. How well does Jesus understand man?

John 3:1-21

John

- v. 1 *Ruler*: probably in the Sanhedrin.
v. 2 *Rabbi*: meant teacher, but also a term of address.
v. 3 Somewhat like the answer to the rich, young ruler — "If God is with me, then here is what God has to say to you." The word translated "again/anew" is *anōthen*. It is used in Mk. 15:38; Lk. 1:2; Jn. 19:23; Acts 26:5; Gal. 4:9; Jas. 3:15. It may have the basic idea of from the start, or beginning. But as Nicodemus implies, a man can not be reborn physically. Hence, it must be done in a realm where such is possible: the spiritual. A second necessity, since humans have little or no control in the spiritual realm, is for God to help. There the genius of the new birth: God's help through the Holy Spirit. No one affirms that water saves, but immersion in water is obedience, and obedience saves, v. 36.
See: probably means experience in this text. Nicodemus so understood Jesus.
v. 4 He expects negative answers.
v. 5 It is rather foolish to take Jesus to say water, *even* the Spirit. However, most commentators who are followers of John Calvin so take it. As remarked in the short selected study on Interpretation, pre-

FIRST YEAR MINISTRY

suppositions play a large part in interpretation. Accept the tenets of Calvinism and it becomes difficult to hold the position that Jesus really meant water.

- v. 6 Like produces like. There are two basic realms: physical and spiritual, but the same principle applies in both.
- v. 8 The Greek word *pneuma* translated "spirit" also means wind/breath. The Old Testament word for wind/breath also meant spirit, and is applied to God. Nicodemus was treated to a discussion that had to do with the spiritual side of life, where the Spirit from God labors. It is meaningful to use the word "wind" in the verse, but probably more correct to translate "spirit" rather than "wind."
- v. 10 "Wake up, Nicodemus!"
- v. 11 *We*: a reference back to the statement in v. 2.
- v. 13 A statement about Jesus' authority—He had come from heaven, and had the right information.
- v. 14 See Num. 21:4-9. The brazen serpent (called *Nehushtan*, "a thing of brass," in II Kings 18:4) had no power inately. People had to look believing. If they did, they lived. So it is with immersion. Water has no power to transform a person's life—but obedience (to God) by immersion in water can bring life: the same principle as the serpent. Obviously, no one obeys unless faith is present. Faith in obedience saves.
- v. 15 *May have*: from a form which indicates "keep having" life.
- v. 16 The problem of deciding whether John wrote this and the following verses, or whether Jesus is yet talking can not be settled. God did not love anyone enough to save them in their sin.

- Only-begotten*: quite misleading. The Greek word means unique (See discussion under Jn. 1:18).
- v. 17 All not saved through Christ are condemned, however. See Jn. 12:44-50.
- v. 18 So all men stand judged as respects eternal destiny at any given moment in life. The appearance before God's judgment bar will only be for sentencing.
- v. 20f. The Greek text describes a habit in life, activity throughout life.

QUESTIONS

126. What signs did Nicodemus have in mind?
127. Are "see" and "enter" synonymous in v. 3, 5?
128. If Jesus did not mean water, why did not Philip, directed by the Holy Spirit, tell the Ethiopian that he had misunderstood what had been said (Acts 8)?
129. If Jesus had not meant water, why would He even mention the term?
130. What is the point of v. 13 in the discussion?
131. Did Moses or the brazen serpent on a pole have power within themselves to save the Israelites?
132. How did the Israelites think a brazen serpent could save?
133. Do evil deeds express one's love?

20. Judea—John 3:22-36

John

- v. 22 *He remained*: probably from Passover time until late December, or about eight or nine months.
- v. 23 Jesus and John were both preaching about the kingdom and immersing those who came and accepted the message.

FIRST YEAR MINISTRY

- v. 24 Obviously an argument, since John's immersion was based on faith and repentance and for the remission of sins. The Jew would be concerned with keeping the law, but more probably the traditions of the law.
- v. 26 Jealousy in John's disciples?
- v. 28 No jealousy in John—he knew his place.
- v. 30 No neutrality is ever possible in the relationship with Jesus.
- v. 31 Again, discussion over vv. 31-36 as to whether John said them, or John the apostle wrote them. Jesus was from above, and the "forerunner" (John) of the earth (below).
- v. 32 *No one*: probably understood in light of v. 33. No one but those who accept it, and in so doing, set their seal (i.e. approve) the testimony given.
- v. 34 What is difficult to decide is this—if Jesus were deity in human form, what need of the Holy Spirit (also deity) to guide?
- v. 35 Note the all-inclusiveness of the gift—all things. See Matt. 11:25-27; 28:18.
- v. 36 The King James translators were Calvinistic in doctrine. Hence they could not "believe" that one had to "obey" to be saved (or that faith and obedience were equal, as Paul implies in Rom. 1:5; 16:26). Hence they translated the Greek term *apeithōn* as disbelieve, and wrongly so. It is a word meaning persuade, plus a prefix which negates the action: not persuaded. One not persuaded to accept Jesus is obviously disobedient in the decision (I John 3:23) and will continue to be so as long as he is not persuaded, as in vv. 18-21. Such a person stands condemned. Death does not change a person's character!

QUESTIONS

134. Why was purification an issue?
135. Why the comment in v. 24?
136. Do you think John's disciples were unaware of his feelings about Jesus? Had they gotten into an argument over whose immersion was "the best"?
137. What image does John have of himself in respect to Jesus?
138. In what way(s) did John think Jesus must increase?
139. Does v. 35 teach two distinct personalities known as Father and Son? (Some assert that the Father and the Son are identical, and only viewed from different perspectives.)
140. Is every person either saved or lost at any time in their earthly life?

21. Sychar—John 4:1-42

John

- v. 1-3 A summary of the rising opposition to Jesus' ministry. He leaves Judea to minister in Galilee for 1 year and 3-4 months. The text does not say Jesus had not immersed people—it only affirms that Jesus' disciples were doing the immersing, as a general rule.
- v. 4 One wonders why Jesus "had to pass" through Samaria. There were several ways to go to Galilee.
- v. 6 *Sixth hour*—either noon or evening, the latter preferable.
- v. 7 Drawing water probably done in evening.
- v. 8 For "openers."
- v. 9 *No dealings*—at least on a personal basis as a normal rule.
- v. 10 Some more "bait."

FIRST YEAR MINISTRY

- v. 11 *Sir*=Greek word often translated "lord". However, it was also used as a term of address.
- v. 12 She implies Jesus is not greater than Jacob. Notice too that she, as a Samaritan, recognizes a common ancestor.
- v. 14 Notice the claim Jesus makes—He never indicates he was anything but deity.
- v. 16 "I will, but before I do, bring your husband"
- v. 19 An understatement! But she is interested in something else now.
- v. 20 Gerizim on the south at 2,850 feet, Ebal on the north at 3,079 feet. The city was in between. See Deut. 27:4, 11-14; Joshua 8:30-35.
- v. 21 *Woman*: not contemptuous. Neither/nor: a whole new ballgame!
- v. 22 The only revealed way of salvation at that time was through the law and the temple in Jerusalem.
- v. 23 *True worshippers*—worshipping by means and use of inner man, and according to reality, not shadow (as was the case with those who worshipped under the law, a shadow, Heb. 9, 10). The same point is made here about man's dual nature as was made with Nicodemus. Man must do more than go through the "motions." The words "in spirit" may include the right attitude, but they basically refer to the real "you" which is spirit.
- v. 24 Hence, God wants worship from spirit beings in the way He has directed.
- v. 26 A direct affirmation of Messiahship.
- v. 27 See v. 9.
- v. 29 She implies the man really is not the Messiah, but whets their curiosity enough to stir them to action.
- v. 33 They were like the woman in v. 15—a little dense.

- v. 34 See Phil. 3:19-20.
- v. 35 *Four months*—spoken in late December or early January, some four months away from harvest time.
- v. 36 The kingdom and its workers deals with things spiritual and thus eternal things.
- v. 38 Perhaps the “others” Jesus mentioned included such as Jacob and Moses, who directed people to God.
- v. 39 The woman “labored” and the fruit was produced.
- v. 42 Salvation was of the Jews.
Notice that the Samaritans were the first to express the concept “savior of the world” though John had expressed basically the same thing (whether he understood it or not) in John 1:29.

QUESTIONS

141. Were John and Jesus together making an impact?
142. What kind of “dealings” were Jesus’ disciples having with the Samaritans? See Luke 9:51-56.
143. Did Jesus really use the word “husband” as if her marriages were recognized as such by God, even though He did not approve of divorce?
144. When people use the term “in spirit” to refer to an attitude and use “lively songs” and entertaining sermons to produce an emotional effect, are such people really much like Nicodemus and this Samaritan lady: thinking primarily of the physical side of life? Would the devil like that approach?
145. What did the Samaritan woman think the Messiah would show her: that she was religiously correct?
146. What do they imply in their remark to the woman in v. 42 about her testimony to them concerning Jesus?
147. What do they call Jesus?

FIRST YEAR MINISTRY

John 4:43-45

Jesus begins a long ministry away from Jerusalem. He spends the next 3-4 months plus the next year in Galilee. The first 6 months of the next year are spent in semi-seclusion, before He ministers again in Judea for any length of time, (However, the events in John 5 occur in Jerusalem, some 4 months hence.) John chs. 7-10. The Passover in John 6 is not activity in Jerusalem.

22. Cana—John 4:46-54

John

- v. 46 Jesus' signs were common knowledge. So His countrymen expect more of what they heard and/or saw in Jerusalem at the Passover feast (John 2). *Official*—from basilikōs, king's officer.
- v. 47 The man assumed two things: 1) Jesus had to go where the boy was, and 2) Jesus must come before the boy died—See Jesus' remarks in v. 48.
- v. 49 *Come down*: a pleading command.
- v. 50 "Even though my faith is small, trusting Jesus—that is all." Faith is only evident in obedience.
- v. 52 *Seventh hour*—probably 7:00 p.m.
- v. 53 A new reason for faith.

QUESTIONS

148. Does Jesus' statement in v. 44 give a reason for going to Galilee, or anticipate a rejection in Galilee?
149. Does Jesus' statement imply that the man only believes because he had seen signs and wonders?
150. When does one know that one has faith? (When one is obedient?)

23 Nazareth—Matt. 4:12-17; Mk. 1:14-15;
Lk. 4:14-30

Matt.

- v. 12 Luke added in ch. 3:19-20 that John rebuked Herod for having Herodias as his wife. Because of this, Herod imprisoned John.
- v. 14 Isa. 9:1-2; 42:7; Lk. 1:79; 2:32.
Naphtali, the sixth son of Leah by Jacob.
Zebulon, the second son of Bilhah, Rachel's maid, by Jacob.

A new day has dawned for people under the shadow of death.

Mark

- v. 14 Mark's account seems to say that Herod may have put John in prison towards the end of the first year of ministry.
- v. 15 Word order is not necessarily meaningful. Note that the order here is 1) repent and 2) believe. Those who argue on the word order in Mark 16:16 have a case that faith should precede any act of obedience, not because of the particular order of words but because of the very nature of the case.

Luke

- v. 15 *Being glorified*—probably ascribing to Him the same sort of praise as Nicodemus gave Him.
- v. 16 The Old Testament knows nothing about the synagogue. It arose in the period after the return from exile. No Jewish person was expected to attend the synagogue services as far as the Old Testament law was concerned. There is nothing in this verse that applies to church attendance other than the fact Jesus went there to learn and teach.

FIRST YEAR MINISTRY

The apostles often visited in synagogues, but not because any law required it.

"*Stood up to read*": the custom. See v. 20.

- v. 17 *Opened*—probably the text was in the form of a scroll, and Jesus unrolled it to the passage read.
- v. 18 Isa. 61:1 in the main, though Jesus inserts a phrase, "and recovering of sight to the blind" not in the verse, and leaves out "he has sent me to bind up the brokenhearted." The thought of the context in Isaiah was for Israel to cheer up, because God was going to bless them. God did bless Israel, through Jesus. See Matt. 11:1ff.
- v. 19 See v. 15 of Mark.
- v. 21 "God has sent . . . here I am."
- v. 22 *Gracious words*—probably not only what but how (manner).
- v. 23 Jesus anticipates their next thought: since Jesus was claiming to be God's gift, work some miracles, etc.
- v. 24 Generally speaking, what Jesus said was true. It was not so much the man himself, as the combination of the man and message.
- v. 26 I Kings 17:1—18:45; James 5.
- v. 27 II Kings 5:1-27.
- v. 28 They got the point: the Jews did not have any "corner" on God.
- v. 29 They did but justify Jesus in His comments, acting just like Israel did in the days of Elijah and Elisha.
- v. 30 We only wonder how Jesus avoided death.

QUESTIONS

151. Do you think Jesus went to Galilee to fulfill the prophecy in Isaiah, or fulfilled it in going?
152. What is meant by the word "light"?

NEW TESTAMENT HISTORY: THE CHRIST

153. Mark's account mentions the "Gospel". How could the Gospel be preached before the resurrection? What does "Gospel" mean?
154. Do you think Jesus might have looked for the text He read in order to teach about Himself?
155. What does Jesus claim about Himself in the synagogue?
156. What puts a person, any person, in contact with God?

24. Capernaum (1)—Matt. 4:18-22; Mk. 1:10-20;
Lk. 5:1-11

Matt.

- v. 18 Because Matthew has not mentioned the men before, he now introduces them. However, after following Him for some time, and ministering with Him in Judea, they are now called to minister fulltime.

Mark

- v. 16 *Net*—Greek amphiblēstron. A small net probably used by one or two men. The prefix amphi means "on both sides". (cf. ambi-dextrous). The root bal means throw or cast. Hence, to throw on both sides of something like fish with a net.
- v. 19 *Nets*—diktua, nets of any kind. Matt. 13:47 has sagēnē, a large drag net or seine.
- v. 20 Note: the hired servants. The two brothers, Peter and Andrew, the brothers James and John with their father Zebedee (mother Salome) had a *fishing business*.

Luke

- v. 1 Gennesaret—(Sea of Galilee also). An Old Testament designation.
- v. 3 Use of the water and shore to amplify voice, and also to get away from the "squeeze" of the crowd.

FIRST YEAR MINISTRY

- v. 5 "Master" indicates long acquaintance. Greek: epistatēs, only in Luke's Gospel. For Peter, the hot sun would cause the schools of fish to seek cooler water, out of reach of nets.
At your word: Jesus was master!
- v. 6 King James has the net broken. The Greek text indicates that the nets were breaking, not broken, which is the reason Peter called for the other partners. Had the net broken, the fish would have been lost.
- v. 7 What a catch! Perhaps Jesus was supplying the men with enough fish to sell so that they could follow Him without apprehension about finances.
- v. 8 *Catching*, from a Greek word meaning "to catch (alive)."

QUESTIONS

157. If the men were washing their nets, what time of the day was it when Jesus came by?
158. That a miracle happened seems obvious. But the miracle consisted of what? a large catch of fish? a catch of fish in the daytime?

(2)—Mk. 1:21-28; Lk. 4:31-37

Mark

- v. 22 The same attitude expressed everywhere else: authority.
- v. 23 *Unclean spirit*—a demon who inhabited the same body as the man did.
- v. 24 The same expression (what have you to do with us) basically is found in Matt. 8:29; Jn. 2:4. "The Holy One"—The demons do know, James 2:19. They never fail to recognize Jesus or submit to His authority.

- v. 26 "Dedemonized" was a rough experience!
 v. 27 A new quality added to teaching.
 v. 28 So the newscasters had a banner day.
 Luke
 v. 31 Word=teaching. Greek *logos*.
 v. 34 A cry (*ea* in Greek) of wonder? fear? submission?
 v. 35 Did all hear the demon's expression?

Throw him down—an unusual synagogue service, we guess. Luke remarks (the physician's care for details?) that despite being convulsed and thrown down, the man was unharmed.

QUESTIONS

159. How do you suppose the man possessed of a demon got in that synagogue? Could the presence of Jesus have drawn him there? or the demon out (of the man)?
 160. What does the demon imply Jesus had the power to do?
 161. Did Jesus do what no human can do?
 162. Why not allow the demon to keep talking about Jesus' identity? (All the demons knew who Jesus was, Mk. 1:34; Lk. 4:41.)

(3)—Matt. 8:14-17; Mk. 1:29-34; Lk. 4:38-41

Matt.

- v. 14 Sabbath day healings were taboo as far as the Jewish hierarchy was concerned. See Luke 13:10-17; 14:1-6.
 v. 15 Note the different descriptions of what Jesus did, Mk. v. 31; Lk. v. 39.
 v. 16 *That evening*—after sundown, the Sabbath over.
 v. 17 Isa. 53:4. Matthew alone records this prophecy and its application.

FIRST YEAR MINISTRY

Mark

- v. 29 Simon and Andrew were of Bethsaida (Jn. 1:44) but apparently (?) lived in Capernaum.
- v. 30 Peter was certainly unlike his supposed successors, the popes—as he had a wife.
- v. 31 *She served*—immediately well and kept serving.
- v. 33 Peter remembered that he thought the “whole town” was there!

Luke

- v. 38 A high (Greek *megaloi*) fever—the fever was holding her.
- v. 40 *He healed* (Greek *etherapeusen*)—people just kept coming, and Jesus kept healing.
- v. 41 *He rebuked*—as in v. 39. See Matt. 16:20, 22; Lk. 23:40.

QUESTIONS

163. What do the three accounts actually say Jesus did when He healed the woman?
164. Why did the people wait until sundown? were they afraid to bring people to Jesus in the daylight? were they too busy in the daytime? Did they think Jesus might be more accessible at night (like Nicodemus, perhaps)?
165. Can you see that long line of people winding around the courtyard and down the block, waiting to see the “great physician”?

25. First Galilean Tour (1)—Matt. 4:23-25;
Mk. 1:35-39; Lk. 4:42-44

Matt.

- v. 23 Jesus was busy: teaching, preaching, healing.
- v. 24 Syria was to the north of Galilee and primarily Gentile country. Perhaps the knowledge of what

Jesus did by people in the north of Galilee was the reason the Syrophenician woman "found" Him, Matt. 15, Mk. 7.

Matthew's account shows that people could be sick but not possessed by a demon, or be demonized and not afflicted otherwise. However, being possessed by a demon sometimes resulted in physical afflictions.

- v. 25 Miracles attracted people from everywhere. However, a miracle sometimes produced no faith at all. John 4:48 may indicate that Jesus did not value the faith they produced, or felt some failed to see what they did mean, Jn. 14:11. Some worked miracles who were not with Jesus apparently, Mk. 9:30-39. John did no miracles at all (Jn. 10:41) but some thought he was the Messiah anyway, Lk. 3:15. Jesus did many miracles, but some thought He was only a prophet while others accused Him of working with Beelzebub. Miracles have some evidential value, but they do not prove anything necessarily.

Mark

- v. 35 If Jesus knew when even one woman was healed (ch. 5:30) because of power having left Him, how much more after a considerable time healing?
- v. 37 *Everyone*—or so it seemed. The only ones who really were not seeking Jesus were some among the Jewish hierarchy.

Luke

- v. 43 Jesus felt constrained to let others share in the things He had to offer.
- v. 44 This verse has an interesting variant about the place where the synagogues were in which Jesus was healing. Some Greek manuscripts read Galilee,

FIRST YEAR MINISTRY

others Judea. Matthew and Mark both indicate a ministry in Galilee. However, both Galilee and Judea may have had ministry by Jesus for all we know. It would be natural for some ancient scribe, while copying by hand these manuscripts, to make all three agree about the place of Jesus' activity.

QUESTIONS

166. Did Jesus ever fail to heal anyone? Did He heal everyone everywhere? If not, why not? Why did He work miracles?
167. What was the good news Jesus wanted to preach?

(2)—Matt. 8:2-4; Mk. 1:40-45; Lk. 5:12-16

Matt.

- v. 2 Describe leprosy as the Bible does.
- v. 3 The leper clean at the touch of Jesus. The leper's approach was correct: the issue was not whether Jesus could heal but whether He would heal.
- v. 4 The man was cured, but in order to be reinstated to society, so that he might participate (see Mark v. 14) in religious activities as well as social activities, he must follow the prescribed rules in Lev. 14. Leprosy was not a moral defilement, but a defilement that affected religious and social relationships.

Mark

- v. 40 *Beseeeching*—Like the men in Luke 17, or Naaman in II Kings 5.
- v. 41 *Pity*—See Heb. 4:14—5:10.
- v. 43 *Sternly charged*—a Greek word of strong meaning, like in Jn. 11:33, 38. See Matt. 9:30, Mk. 14:5.

Luke

- v. 14 Jesus never broke any Mosaic law, nor taught others to do so, either by precept or example.

QUESTIONS

168. Where does the Bible say that leprosy is like sin or death?
169. Does the Bible say a person could become unclean by touching a leper?
170. Why do you suppose the man disobeyed Jesus?
171. Could he keep the fact of being free from leprosy a secret, even if he said nothing?

(3)—Matt. 9:2-8; Mk. 2:1-12; Lk. 5:17-26

Matt.

- v. 2 The man was paralyzed inasmuch that he apparently could not walk at all. Otherwise, they would not have torn up a roof to let Jesus heal him, Lk. v. 19.
- v. 3 Note that the scribes knew what blasphemy was. It was claiming to be deity. Caiaphas knew also. That is why he tore his garments when Jesus responded to his question, "Are you the Messiah, the Son of God," Matt. 26:63. Jesus' reply was affirmative, which was considered a false claim by Caiaphas and the Sanhedrin.
- v. 4 Jesus accuses the men of thinking evil, which means wrong thoughts. The right thoughts would have been that He had the authority to forgive sin.
- v. 5 The easier thing to "say," humanly speaking, was the thing Jesus said, since no one could prove or disprove that the man's sins were forgiven. The men might have thought Jesus was trying to "show off" in a way no one could contest His claims. For Jesus, either thing was easy.
- v. 6 From the healing Jesus drew this conclusion: only deity can do such things, hence, I am deity.
- v. 8 The crowds still miss the point Jesus made.

FIRST YEAR MINISTRY

Mark

- v. 1 Jesus could not keep hidden.
- v. 2 Like the crowd around the house in 1:33.
- v. 7 The scribes understanding was good, their reasoning about Jesus, bad.
- v. 12 *Amazed*—existasthe, just so startled that they were "beside themselves." See Mk. 3:21 where the same word occurs.

Luke

- v. 17 Note that Luke adds Pharisees to the scribes of Matthew and Mark. Some were from 70-100 miles away.
- v. 26 *Strange things*—Greek is paradoxas, or paradox.

QUESTIONS

- 172. Whose faith did Jesus see?
- 173. How many people were present?
- 174. Why do you suppose one of the man's friends did not go tell Jesus about their problem, rather than tearing up the tile roof?
- 175. How quickly did Jesus discern the thoughts of the men?
- 176. Is "seeing believing?"

(4) and (5)—Matt. 9:9-17; Mk. 2:13-22;
Lk. 5:27-39

Matt.

- v. 9 After all the preaching, teaching and healing Jesus had done, Matthew quite probably knew Jesus or about Jesus very well. Read again Matt. 4:24; Mk. 1:28, 45.
- v. 10 *The house*—most natural if it were Matthew's house. *Tax-collector* (K.J. "publican").

NEW TESTAMENT HISTORY: THE CHRIST

Sinner—the contemptuous term used by Pharisees and scribes for others thought lower than themselves.

- v. 11 Maybe the other disciples were not with Jesus, or perhaps were in another group with the Pharisees, and all watching the feast.
- v. 12 Matthew alone has the verse from Hos. 6:6. See especially Mic. 6:6-8.
- v. 13 If the Pharisees had really been able to see themselves as God saw them (merciless, sinful, sons of hell) they would have called for an ambulance and been taken to the emergency room and a doctor immediately.
- v. 14 The disciples of John asked Jesus about the seeming "eat, drink and be merry" life being led by Him and His disciples.
- v. 15 His reply: "It's time to make merry and be glad!" The same general idea of a wedding had been used by their own leader in Jn. 3:29.
- v. 16 A tremendous important principle stated here and in v. 17: No one mixes the wrong things. Applied to Jesus and the kingdom: the law and the kingdom do not belong in the same thoughts even! Note the attempt to add law to Gospel in Acts 15, and the steadfast refusal by the apostles led by the Holy Spirit to let it happen.

Mark

- v. 13 Note the addition Mark makes to Jesus' activity before the call of Matthew.

Luke

- v. 28 Matthew "left all" to follow Jesus.
- v. 32 Luke adds "to repentance." Jesus had been preaching that people should repent and believe the Gospel, Mk. 1:14.

- v. 39 The new is not wrong because it is new, anymore than the old is wrong because it is old. The old was new once. The "old" (will) and the "new" (will) were in complete agreement, but not the same thing at all. One (the old) was shadow, the other (the new) is the substance.

QUESTIONS

177. What do you know about Matthew? his book?
 178. Was sacrifice not expected by God of the people? (See Isa. 1:10ff.)
 179. Is the Christian to consider all of life of beneficial help, regardless of what happens? (Have you read Rom. 8:28?)
 180. Why do people want rules to keep? (or for someone like the preacher to tell them just how far is far enough?)
 181. How does a person decide if he is sick or well?

26. Jerusalem—John 5:1-47

John

- v. 1 Probably Passover, though Pentecost is also likely.
 v. 5 Whether or not the man had been at the pool waiting to be healed 38 years is not known though unlikely. Doubtless, like others with incurable ailments, he had tried everything (see Mk. 5:26).
 v. 6 Jesus asked the obvious it seems. Maybe the man was making a living being "poor?"
 v. 8 Notice that Jesus did not say anything about healing—the man had to believe Christ.
 v. 10 Nothing in the O.T. forbade the act—their conclusion was a result of interpretation.
 v. 12 Do you see why Jesus had said in Matt. 9:13, "I desire mercy and not sacrifice?"

NEW TESTAMENT HISTORY: THE CHRIST

- v. 13 Perhaps the whole incident occurred at the pool with little notice of the man and Jesus.
- v. 14 The Greek text (mēketi hamartane) indicates that Jesus told the man to not let sin be habitual in his life. Sin brings much worse results than any physical ailment.
- v. 15 That's appreciation for you!
- v. 16 See Jn. 7:19-24; 10:31-38.
The Jews kept at it for over two years until they got Him killed.
- v. 17 The text in Gen. 2:2 only indicates that God ceased creating. He did not cease sustaining what He had created.
- v. 18 Jesus claimed not only to know what God was doing, but also the right to do the same things. Thus the Jews rightly concluded He was claiming to be deity.
- v. 19 This section, 19-29, shows some of the ways Jesus considered Himself equal with God the Father. Both do the same things.
- v. 20 Both know and act alike.
- v. 21 See Jn. 1:3-4.
- v. 22 Only God can rightly judge.
- v. 23 The unity of the two personalities makes it impossible to honor or dishonor one without also doing the same thing to the other. See I Jn. 2:23.
The Greek text indicates habitual action: honoring/not honoring.
- v. 24 If God gives life, and Jesus is God, then to accept His word is to receive life. The possession of life means avoidance of judgment. See vv. 28-29; ch. 3:16-21, 36.
- v. 25 The dead may mean physical or spiritual. Jesus raised to life physically dead, and also spiritually dead. Those who hear (hoi akousousin) are like

SECOND YEAR MINISTRY

- the one(s) in v. 24: (the one hearing (ho akouōn) and believing (ho pisteuōn)) habitual hearers.
- v. 28 Jesus speaks from the "understanding point" of His listeners; no one is "dead" to deity.
- v. 29 The evil person is condemned at any given moment in life. Death physically does not change that fact.
- v. 30 This shows the unity of the Son and the Father (so called that we may distinguish between two separate personalities, both of whom are deity.)
- v. 31 The O.T. law required two or three witnesses to establish truth, Deut. 17:2-6. See Jn. 8:14; Heb. 10:28. Jesus will now list five witnesses for His deity: John, miracles, the Father, O.T., Moses.
- v. 33 Ch. 1:29-36.
- v. 35 Note ch. 1:6-8. How pitiful that more did not honor John's testimony.
- v. 36 The whole discussion started over a miracle Jesus worked and the conclusion the man healed drew from it (that the one who healed him also could tell him to carry his pallet on the Sabbath).
- v. 38 Perhaps the witness of which Jesus spoke was the voice at His immersion.
- That they were (as a whole) failing to do God's will (accept Him as the Messiah) gave proof that God's word was not in them.
- v. 39 *Search* (Greek eraunate)—not a command, but a statement. Better translated "You are searching (regularly)." The Jews did so, but their presuppositions blinded their eyes. Read Jesus' efforts to explain the real message of the Law, Psalms and Prophets in Luke 24.
- v. 40 The life-giver, to whom the O.T. pointed, was Jesus. Rejection of Him meant death.
- v. 41 Jesus may mean 1) I do not accept any praise

- from men, or 2) I am not getting any praise from men.
- v. 42 Obviously, since they were thinking of ways to kill Him, v. 18, ch. 8:39ff.
- v. 43 Not good judgment at all!
- v. 45 "Quit thinking that I . . ."—"Start thinking that Moses. . ."
- v. 47 A testimony to the fact of 1) Moses, 2) that he wrote and 3) the subject of Moses' writing was Christ. Some did believe Moses and the prophets; see ch. 1:41-46.

QUESTIONS

182. Why was the feast left unnamed: was it because it was unimportant? or because it was so clear that no need existed to mention it?
183. Did the man want to be healed?
184. What assumption did the man make about carrying his pallet?
185. Could sinful practices cause something worse than 38 years of bodily affliction?
186. Do you think Jesus did the miracle to make an opportunity to teach about Himself?
187. How many perogatives of deity does Jesus claim?
188. If we accept Jesus we have life (as Jesus taught, and John wrote, I Jn. 5:11-12). If we do not accept Jesus, what do we have? (see v. 29).
189. How many witnesses does the "defense" list?
190. Did the Jews not know their Bible, or did they have the wrong presuppositions in studying it?
191. Who was going to accuse (Greek *katēgorēsō*, our "categorize") the Jews of bad interpretation at the judgment, and why?

SECOND YEAR MINISTRY

Galilee (1)—Matt. 12:1-8; Mk. 2:23-28;
Lk. 6:1-5

Matt.

- v. 1 The party is traveling—in spite of tradition's restrictions to $\frac{7}{8}$ of a mile? on the Sabbath?
See Deut. 23:24-25; Ruth 2:15-16.
- v. 2 It was not lawful only because of their interpretations, which Jesus will soon point out.
- v. 3 *Have you not read*: indeed they had—a bit of irony. See I Sam. 21:1-6.
- v. 4 Mercy outweighed law.
- v. 5 The hardest working people were the priests on the Sabbath. Hence, the O.T. law did not forbid work as such.
- v. 6 If the priests could "work," so could the disciples: both groups "working" for God. One must then define "holy" in the fourth commandment and "work" in a different way than lack of expenditure of energy.
- v. 7 Someone has well said, "A sacrifice without mercy is a rule kept without love." When God's laws get to be a duty and not a delight, something is wrong with the "doer." Hosea 6:6. Notice: the "guiltless" (i.e. Jesus' disciples).
- v. 8 Jesus obviously claimed such perogatives as only God could claim.

Mark

- v. 23 Probably early grain like barley or wheat.
- v. 24 Wonder if the Pharisees were "omnipresent" wherever Jesus was?
- v. 26 *Abiathar*—the O.T. account has Abimelech. Perhaps Abiather was another name for Abimelech, or his son and successor.
- v. 27 And so with all of God's created world, Gen. 1:28.

Man must use it rightly, but nothing was intended to be a bane rather than a blessing.

Luke

- v. 1 Seems to imply the second Sabbath of two in a row. "rubbing"—the Pharisees thought this was threshing, and threshing was "work." Read Ex. 16:22-30; 20:8-11; 23:12; Num. 15:32-36.

QUESTIONS

192. List the five reasons Jesus gave that showed His disciples were guiltless.
193. What was greater than the temple and why?
194. Wherein did the problem lie: the O.T. law or the interpretation of the law?

(2)—Matt. 12:9-14; Mk. 3:1-6; Lk. 6:6-11

Matt.

- v. 9 "Their"= Jews.
- v. 10 The Pharisees and scribes had ruled out any healing on the Sabbath unless the person was at the point of death. They simply failed to understand God's intent for the day. No one, then or now, ought to set an interpretation up as infallible and authoritative for anyone except himself. We are obligated to obey God's law as we understand it, but we certainly have no reason to think anyone else has to keep it like we understand it.
- v. 11 They all did or thought it was proper.
- v. 12 So a man is worth more than a sheep in God's eyes. We get an authoritative interpretation of a proper use of the Sabbath.
- v. 13 Jesus taught here that if the Sabbath could not be used to help a man, then the Sabbath was a curse not a blessing. God never intended it to be a curse.

SECOND YEAR MINISTRY

Mark

- v. 2 *They watched . . . to accuse:* real godly, they were.
- v. 4 His answer to their question recorded in Matt. v. 10. Note that it was not a question of "doing"—it was rather a question of doing *good* or doing *evil*.
- v. 5 It was not that they could not understand the right way—it was rather they would not understand. See Heb. 3:12.
- v. 6 Pharisees and Herodians: the only common bond was hatred of Jesus. Politics makes strange bed-fellows. Herodians were "pro-Herod," who was pro-Rome.

Luke

- v. 6 Luke notes a right hand withered.
- v. 7 They paid Jesus an unconscious compliment in watching to see if He *would heal*.

QUESTIONS

195. How many things has Jesus taught could be done on the Sabbath and yet keep it holy?
196. What conclusion did Jesus intend for the onlookers to draw about Himself and the Sabbath? (Theologians today would talk about event and interpretation.)
197. Was God's command to be understood as forbidding all energy expenditure on the Sabbath?

(3)—Matt. 12:15-21; Mk. 3:7-12 (Lk. 6:17-19).

The text in Luke 6 is a parallel account of the same general activity as in Matt. and Mark. We will discuss it along with the Sermon on the Mount.

Matt.

- v. 15 All were healed, and many from far away places, like Idumea (Edom) and Sidon.

NEW TESTAMENT HISTORY: THE CHRIST

- v. 17 Isa. 42:1-4. A testimony to the authorship of the passage that some consider to have been written by someone other than Isaiah.
- v. 18 See echoes of this thought in Matt. 3:17, Jn. 3:34.
Gentiles—God had predicted a world-wide mission for His Servant 700 years before the Servant came. This was one of the passages the Jews did not “read.”
- v. 19 Jesus’ ministry one of building, not destroying.
- v. 20 The figures of speech are to show how carefully and tenderly Jesus ministered to people.
Victory and *justice*: hallmarks of the reign of the Prince of Peace.
- v. 21 The Messiah: for the Gentiles, too. See Acts 11:18 for a belated recognition of truth of long standing.

Mark

- v. 7 *Crush*—see Luke 5:1; 12:1. The Greek word is *thlibō*, often translated as affliction or oppress. See Mt. 7:14; II Cor. 1:6; 7:5; I Thess. 3:4; I Tim. 5:10; Heb. 11:37.

QUESTIONS

198. Do you think the Jewish people actually wanted the Gentiles to be saved?
199. How do you understand v. 19 in connection with such chapters as Matt. 23?

(4)—Mk. 3:13-19a; Lk. 6:12-16

See the remarks in the section of general comments about these men. Mark 3:19b is to be used later under # 30 (1).

SECOND YEAR MINISTRY

(5)—Matt. 5:1—8:1; Lk. 6:17-49

Matt.

- v. 1 *The crowds*—explained by Luke to include those who were disciples of Jesus, and those just designated as the 12.
- v. 3 Jesus came to preach to people who were poor, Mt. 11:5; Lk. 4:18. Note also that Luke's text has poor. Isa. 61 has a word meaning afflicted in some way, not necessarily materially. Here it is poor as a state of mind, recognition of lack in one's life.
- v. 4 Perhaps recognition of one's own status in life as seen in the tendency to be happy with the wrong things and not God's. See Psalms 51:17.
- v. 5 *MEEK*: those people who are in control of self to such an extent that they habitually do God's will (in any area, morally, socially, emotionally, etc.) rather than be conformed to the world around (II Peter 2:19).
- v. 6 Basic desires are hunger and thirst. The approval of God above all must be our insatiable longing (Psalms 42:1-2).
- v. 7 One is like God in being merciful. Ref. Joseph in Gen. 45:4-15; Hosea 3:1-3; Luke 23:34.
- v. 8 *Purety*: the state of being unalloyed, thus wholly devoted to God. "It is no more I that live but Christ. . . ."
- v. 9 *The message*: Be reconciled to God, II Cor. 5:18ff. The Good News for all is God has visited and redeemed His people. See Isaiah 26:3; 57:19; Acts 10:36; Rom. 5:1.
- v. 10 See John 15:18—16:4; I Peter 3:13-18; 4:12-16; 5:9-10.

Luke

- v. 17 The preceding verses (12-16) record that Jesus

had been all night upon a mountain in prayer. Perhaps the crowds came out to meet Him in the morning, or He came down and called them together—we do not really know how they gathered, nor where the mountain was.

- v. 20 Jesus wants the disciple to realize that regardless of the circumstances, the situation is in good hands (God's) and everything is "A O.K."
- v. 22 Compare I Timothy 3:7.
- v. 24 See I Timothy 6:17-19.
- v. 25 Implied is the idea that one ought not to be satisfied with this world. The backdrop would be Noah's day; Sodom and Gomorrah; Chorazin, Bethsaida and Capernaum; Rev. 6:15-17.
- v. 26 See Jer. 5:30-31; then Isa. 5:20; Mal. 2:17.

QUESTIONS

- 200. How does one remain trustful of God when (what we call) tragedy happens?
- 201. Should one give all of one's goods to feed the "poor" so that they will be blessed, and, since the person giving the goods away has none left, and is now also "poor," both get a blessing?
- 202. How would one's life be changed if righteousness were as coveted as food and drink?
- 203. Is the prophet (i.e. spokesman) of God in the minority normally? Are most people nice as long as the Christian is not "pushy" with Christianity?
- 204. How much should one court the disfavor of men in seeking to escape the condemnation of Luke v. 26?

Matt. 5:13-20

Matt.

- v. 13 Salt and light—did it ever occur to you how essen-

SECOND YEAR MINISTRY

tial these two things are? The Christian is like them!

- v. 17 "Quit thinking that I have come to destroy. . . !" Jesus was not against the principles contained in these things. The covenant containing the law and the prophets was to be replaced. The timeless moral principles within that covenant were not.
- v. 18 Jesus fulfilled the demands of the law. See Rom. 8:3.
- v. 19 Hence, Jesus invariably upheld compliance to the law, though actively opposing misinterpretations of it.
- v. 20 They "relaxed" and "taught"—see Matt. 23:1ff., etc. Some consider that the rest of the sermon through 7:12 is an effort to show how the law was expected to be kept. Then 7:13-28 a challenge to compare "teachers."

QUESTIONS

205. Why did Jesus use the metaphors of salt and light?
206. Suppose men praise you for a class well-taught, a song well-done, or a sermon well-delivered—what should you do in relationship to v. 16?

5:21-26

- v. 21 The sixth commandment, Ex. 20:13.
- v. 22 The killer becomes so progressively. Anger becomes action. Actions are irrevocable, though perhaps forgivable. Better to "nip it in the bud."
- v. 24 If it is up to us to make the move—make it!

QUESTIONS

207. Why is Paul's advice in Rom. 12:1-2 pertinent here?

208. Is it important to get right with God's will before we get "hailed into court?" Does God's will include relationships to others?

5:27-32

- v. 27 Ex. 20:14, the seventh commandment.
- v. 28 *Lustfully*—not only the act in thought, but a violation of the tenth commandment as well. The misuse of self in such thinking is quite wrong, and the thought is ungodly: both are bad stewardship of body and time.
- v. 29 Perhaps literally. If it were literally practiced, men (and women) would more carefully consider how they thought.
- v. 32 Jesus wants the ideal relationship, which includes both faithfulness and forgiveness.

Perhaps the occurrence of the various words translated either as fornication (unchastity) or adultery, etc. will be of interest. Some uses (not all) are given, with the Greek words and English words normally used to translate the Greek terms.

1. Fornication (*porneia*)—Mt. 5:32; 19:9; 21:31ff.; Mk. 7:21; Lk. 15:30; Jn. 8:41; Acts 15:20, 28; 21:25; I Cor. 5:1; 5:9-11; 6:13, 15, 18; 7:2; 10:8; II Cor. 12:21; Gal. 5:19; Eph. 5:3; Col. 3:5; I Thess. 4:3; I Tim. 1:10; Heb. 11:31; 12:16; James 2:25; Rev. 2:21; 14:8; 17:2, 4, 15; 18:3, 9; 19:2; 22:15.
2. Adultery (*moichalis*)—Mk. 5:27, 28, 32; 12:39; 19:9; Mk. 8:38; 10:11-12, 19; Lk. 16:18; 18:11, 20; Rom. 2:22; 7:3; 13:9; I Cor. 6:9; Heb. 13:14; James 2:11; 4:4; II Peter 2:14; Rev. 2:22.

QUESTIONS

209. When does the natural desire (for anything) become sinful?
210. What does Paul affirm about sexual relationships with others in I Cor. 6, and II Cor. 6 (i.e. is the sex relationship only outwardly or does it involve the whole person, which makes it both so meaningful and so involving, emotionally, psychologically, etc.)?

Matt. 5:33-48; Lk. 6:27-36

Matt.

- v. 33 See Lev. 19:11-12; Num. 30:1-15; Deut. 23:21-23.
- v. 34 James 5:12. But see Mt. 26:23; Rom. 1:9; II Cor. 1:22; Gal. 1:20; etc. It is not forbidden if the culture of which one is a part demands it. Jesus means a disciple should have enough integrity that oaths are not needed to back up what the disciple says or does. Hence Peter's affirmation in ch. 26:72, 74 that he was not a disciple of Jesus, and the oath he took to make the statement carry more force were out of character for any disciple. When Peter realized he had not done what Jesus here commanded him to do (be honest!) he went out and wept. Not only was the affirmation wrong, but he had affirmed (and called God to witness to the truth of it) that he, Peter, did not know Jesus.
- v. 35 Every oath is ultimately traceable to God, since God made everything.
- v. 37 If the heart is right, the life will be.
- v. 38 See Ex. 21, 22 for general laws of repayment, especially 21:23-24 where this quote is located.
- v. 42 Moral of passage: do not demand your rights but rather be ready to give, even if it costs. However,

that attitude (the willingness to be misused) needs to be tempered with adequate concern for the other people involved. Hence, Matt. 7:12 and Lk. 6:32 come into play. Our text is but one of the many applications of the principle found in the Golden Rule.

- v. 43 The first half of this quote is from Lev. 19:18, and one of the two great commands, Matt. 22:34-40. The second half was Jewish addition in relationship to the immediate context. God is willing to do more—so must the disciple.

Luke

- v. 27 Sometimes even non-disciples do what disciples are supposed to do. Shame on us as disciples for failure even to match them!
- v. 31 This tempers the whole account: the good of (all) others must be considered in anything we do.
- v. 35 Probably only in personal relationships. Yet stewardship of possessions must be considered too. God expects an accounting from everyone even if He is kind to the unkind and merciful to the unmerciful!

QUESTIONS

211. Why is anything more than a "yes" or "no" (based on integrity of character) of evil? Is it because men want to be (or are) dishonest that oaths are needed?
212. Why can not a married man (with family) just give to anyone and everyone who asks whatever they ask: is that not what Jesus says to do?
213. Is compulsory service really satisfactory or satisfying?

SECOND YEAR MINISTRY

214. Can we be perfect in every way as God is? If not, how did Jesus expect us to be perfect as God?

Matt. 6:1-18

Matt.

- v. 1 The Greek text from which the King James version was translated had the word for "alms" in it. The better Greek text has the word for righteousness. The subject of vv. 2-18 is how to be pious without being ostentatious ("show-off") about it.
- v. 2 Hypocrites—really "blowing their own horn!"
- v. 4 Point: do not do such things we call acts of charity for praise of men.
Openly—only in King James. A poor Greek text here as in v. 6, 18 where "openly" occurs. God does not promise to necessarily reward anyone during life here on earth. The only rewards may be in heaven.
- v. 6 Prayer is indispensable for the disciple. But public acclaim as a reason to pray is damning.
- v. 8 It is not wrong to repeat prayer (Jesus did, Paul did) but if we think repetition is needed to get God's attention, we are poor stewards of our time and energy. When you pray, have some reason other than to get God's attention.
- v. 9 Father: settles relationships with everyone and everything. The prayer is for a child on speaking terms with a Father Who cares.
Our—new wine in new wine skins for the Jew.
- v. 10 All the petitions Jesus gives are in the form of commands. So, we are expected to help God do what we command. Thy—the Greek text is "your." "Thy" is an old English pronoun form to indicate one person rather than two. There is no sanctified

prayer language as such. Jesus taught His disciples to address God respectfully but directly: You. The form "you" is not disrespectful necessarily, though it may be so used. Hypocritical prayers have doubtless been uttered by use of "thy," "thine" and "thou."

- v. 11 Daily—The Greek word is quite an enigma. No one knows exactly what it means. The total Bible context probably indicates "today's" needs. Yesterday is past. Jesus teaches not to be overly anxious about tomorrow in this very sermon. Hence, "today" is all that is left to pray about. As 5:44-45 indicate, God may bless in many ways, even those undeserving. But we are instructed to ask, and some things need to be asked for!
- v. 12 No one has an exactly right relationship with God and yet does not recognize an obligation to fellowmen. See Lk. 17:1ff., and I Jn. 4:19-21.
- v. 13 Compare Jas. 1:2, 13, as well as Rom. 8:28. Some take this verse to mean lead us through (out of) temptation, others keep us out of it. Some think it means to teach a total dependance on God, I Cor. 10:13. Temptation is a daily part of life for moral beings. We should avoid yielding as if God pardoned no one anytime.
- v. 14f. Much disputed passage. Some can not accept the fact that salvation is conditional, and especially conditioned on such as is mentioned here. Yet it seems plain enough.
- v. 16 *Disfigure*—cover up only to show up.

QUESTIONS

- 215. Has it always been a problem to be "religious" without being a "show off?"

SECOND YEAR MINISTRY

216. How do you harmonize 5:16 with 6:3-4?
217. How many times did Jesus pray the same prayer in Gethsemane? How many times did Paul pray about his physical problems?
218. If we pray daily for physical needs, and for forgiveness, is this "repetition" wrong?
219. Should we pardon others as if we had also sinned and needed pardon?
220. Could one honestly fast and yet appear normal?

Matt. 6:19-34

Matt.

- v. 19 The common possessions of that day were susceptible to moths and rust (brōsis, "that which eats").
- v. 20 Cf. Lk. 12:15-21; 16:9-13.
- v. 21 An invariable principle (remember Lot's wife? Lk. 17:32).
- v. 22f. Illustrates the need for priorities like those in vv. 19-24ff.
- v. 24 The very act of obedience to one master is disobedience to the other. Rom. 6:16; II Pet. 2:19; Rev. 3:14-21.
- v. 25 *Anxious*—reckless or indifferent. Martha was this way, Lk. 10:41. See Phil. 4:6-7.
- v. 26 If God does such little things, will He not also do the big things?
- v. 27 Cubit—approximately 18"
Length of life (stature, K.J.) The Greek word (hēlikia) is found in Lk. 2:52. It may mean either stature or length of life but both are practically impossible.
- v. 29 *Solomon*: Jesus knows about his wealth and attainments.
- v. 30 Unbelief results in "worldly care" and such is un-

necessary and unbecoming for the disciple. See Lk. 21:34-37; Heb. 13:5.

- v. 32 Don't be as those who have gods like Psalms 115:3-8 or Hab. 2:18-20. See also Jer. 10:6-16.
- v. 33 The portrait of a man with a new heart!
- v. 34 Let's not get attached—we are just passing through.

QUESTIONS

- 221. Does Jesus forbid any saving accounts, or investments of any kind (such as a home) in v. 19? See Lk. 9:58.
- 222. How can light be darkness? Does light not eliminate darkness?
- 223. Is it possible to "moonlight" (hold two jobs at the same time) according to Jesus? Or is the issue only to serve God or to not serve God (as He expects us to serve)?
- 224. Birds never "worry" about food to eat ("worry" is a *human expression*) nor does grass "worry" about looking nice—what is the point of vv. 25-30?
- 225. Is Jesus talking about "putting first things first" in v. 33 rather than forbidding us to work for food and clothing?

Matt. 7:1-12; Lk. 6:37-42

Matt.

- v. 1 Probably misused about as much as any verse in the Bible. The Greek construction expects a cessation of current practices, especially seen in the Pharisees and scribes, who censured everyone by their human standards. Almost all were "sinners" according to their judgment. However, vv. 5, 6 demand, not that we play God, but that we practice discernment in every situation.

SECOND YEAR MINISTRY

- v. 2 If you do not believe it, try it!!
- v. 3 Nothing wrong with discernment of speck, or removing same.
- v. 5 Error: failure to see self in the same light.
- v. 6 Swine were unclean and unworthy to Jews. Some people may also be (judgment of character demanded). See Acts 13:8-12. Note Jesus' commands to the 12 in Matt. 10:11-15.
- v. 7 *Ask, seek, knock*—all present imperatives in Greek, implying habitual action.
- v. 11 Even less than perfect people can do good—how much more God!
- v. 12 The basis for human relationships is God-given. Apply this verse to the other fellow who thinks you need help and refuses to see he also does, for example.

Luke

- v. 37 *Forgive*—the better way. Not that other's sins are overlooked, but rather that we practice for others what we want practiced for us.
- v. 39 Yes, they both will fall into the ditch.
- v. 40 Setting up the discussion beginning in v. 43 (amplified by Jesus in that He is the teacher they ought to follow).

QUESTIONS

- 226. Do you remember 5:20? Do you suppose the listeners were thinking about what Jesus had been preaching and applying it to others rather than self?
- 227. How can help be given if the person's character and condition are not analysed (i.e., judgments made about him)?

228. If one sees what Jesus required, and despairs of being able to do it, what does Jesus recommend?
229. How can the principle in 7:12 be the basis for all the law and the prophets? Is it really all that important?

Matt. 7:13-20; Lk. 6:43-45

Matt.

v. 13 *Narrow*—because God only intends for us to bring self, not the world with us.

Hard—compressed (the word occurred in Mk. 3:9. See also Acts 11:19; II Cor. 1:6; 7:5; Col. 1:24; Heb. 11:37.)

v. 16 The fruit of a teacher may not be determined immediately, anymore than a tree bears instant fruit. Determination of what his principles will produce (i.e. cause and effect) should be carefully considered.

Contrast is especially between Jesus as “teacher” and anyone else.

v. 20 *Them* (i.e., the prophet/teacher).

Luke

v. 44 Each produces after its kind, Gen. 1.

v. 45 Hence, a teacher’s character and principles taught must be seen and understood before one comes to learn. The big contrast in the text is between God’s teaching and that of anyone else.

QUESTIONS

230. Why was it necessary to talk about two gates? Why not one, or three, etc.?
231. What is the connection between this whole sermon and the instruction given in 7:15-20?

SECOND YEAR MINISTRY

232. What part would individual Bible study have in obeying what Jesus says in 7:15-20?

Matt. 7:21—8:1; Lk. 6:46-49

Matt.

- v. 21 Professions are of no avail without doing. One is only hypocritical.
- v. 23 Judas Iscariot worked miracles and preached and followed Jesus.
- v. 24f. Only two classes of people because there are only two ways—and only two rewards.
- 8:1 Some still were with Him in spite of ending on a "minor note."

Luke

- v. 46 Which master are you serving? (6:24).
- v. 47 *Dug deep*—a sure foundation if possible. See Acts 4:11; I Cor. 3:11.

QUESTIONS

233. Why does Jesus end this sermon with things "crashing around one's ears?"
234. Wherein did Jesus express authority in this sermon?

(6)—Matt. 8:5-13; Lk. 7:1-10

Matt.

- v. 5 One of admirable men in N.T. He understood authority when he saw it.
Beeseeking—kept on doing it. The servant was in bad shape, and "dear" to him. Unusual Roman for sure!
- v. 7 Contrast the official in Jn. 4:47; Mary and Martha in Jn. 11.
- v. 10 *Marvelled*—only here and in Mk. 6:6.
- v. 11 "In his name shall the Gentiles hope!"

v. 12 *Sons of kingdom*—just in appearance: started fast but didn't last.

v. 13 Wasn't Jesus marvelous?

Luke

v. 1 We are following Luke's chronological order almost all of the time, because Matthew seems to be topically arranged rather than chronologically. Matthew's account is quite orderly in the way he wrote it.

v. 2 *Dear*—very few slaves rated this high!

v. 4 Really unusual Roman to have Jews say he was worthy. Notice his own appraisal of himself in v. 6.

v. 7 *Servant*—Greek *pais*. Perhaps a younger child. However, in v. 10, the *pais* is called *doulos*, "servant," or "slave."

QUESTIONS

235. The one remarkable point about this man's faith in Jesus was what?

236. The Roman centurion had done what for the Jews?

28. Nain—Luke 7:11-17

Luke

v. 11 *A great crowd*—this year of ministry is often called the year of popularity.

v. 12 *Only*—same Greek word as in Jn. 1:14, 18; 3:16. large crowd—friends, neighbors, those who perhaps were hired to mourn.

v. 13 *Do not weep* (Greek: quit weeping. See I Thess. 4:13ff.).

v. 14 See Rom. 14:7-9.

v. 15 He had ceased belonging to her at death.

- v. 16 *Prophet*—not enough!
God—not literally.

QUESTIONS

237. Jesus and the crowd with Him met the funeral procession where?
 238. Was Jesus caused to become unclean ceremonially (no sin involved) when He touched the bier?
 239. How did Jesus address the young man (neaniskos)—as if he were living or dead?
 240. Why should fear seize the people?

29. Capernaum (1)—Matt. 11:2-19; Lk. 7:18-35

Matt.

- v. 2 The one coming (Greek ho erchomenos) had been the subject of John's preaching, Matt. 3:11; Jn. 1:15, 27.
 v. 4 This did not fit John's description of the coming one, however. That was the problem.
 v. 6 A subtle hint for John to keep trusting. Discouragement does strange things, and time tests everything.
 v. 7 "No" answer expected.
 v. 8 Again, no.
 v. 9 If you did, you saw one, and that's for sure.
 v. 10 Mal. 3:1.
 v. 11 Greater in the sense of privilege, not service.
 v. 12 In the short span of time since John started preaching, all kinds of people made all sorts of attempts. See Jn. 2:24; 6:15. Perhaps the same sort of thing is seen in Acts 15:1ff., and the book of Galatians.
 v. 14 Thus fulfilling the prophecy of Mal. 4:5-6, which, in turn, was the signal for the Lord's coming (and the kingdom which He brought).

v. 16 Childishness was the prevailing characteristic.

Luke

v. 23 *Offense*, from Greek skandalon, a bait or snare, thus the means by which something is entrapped. Then a cause of getting caught, or cause of falling. See Lk. 21:34; Rom. 9:33.

v. 29 The people immersed by John and who heard Jesus say this in defense of John considered that God had kept His promise.

v. 33 Jesus means John led a rather abnormal life, while He, Jesus, led a normal life, neither of which was in keeping with the ideas of the Pharisees and scribes (lawyers).

v. 35 Probably conveys the idea that everyone is happy with the product of their decision in regard to John and Jesus.

QUESTIONS

241. Jesus did not answer John's question directly—or did He?

242. Who had "stumbled over Jesus?"

243. Did Elijah really come back to life?

244. In consideration of v. 14 (v. 27 of Luke), how should one understand prophecy? What is the reliable key for understanding prophecy?

245. Do people today still rationalize about their conduct in relationship to God's will?

(2)—Matt. 11:20-30

Matt.

v. 20 *Upbraid*—As in Lk. 10:13-15. Jesus is pronouncing judgment (and chopping down fruitless trees), foretelling the inexorable doom of unbelievers in the three cities, even as John predicted.

SECOND YEAR MINISTRY

v. 21 *Mighty works*—reasons to believe (cause and effect principle).

Repented—See Lk. 13:3. Unbelief is deliberate, and thus damning, because sinful.

v. 23 *Sodom*: so Jesus knew about them, too. See Jn. 8:58.

v. 24 The people were simply of careless attitude. Someone has well remarked, "I never did a thing" is a basis for condemnation, not a means of defense.

v. 25 God's cause of action is right. Men who refuse to be "poor in spirit" will be like those in Chorazin, etc. No one has exclusive claim on God: all can believe if they choose to do so.

v. 26 The prophet Jeremiah (31:31-34) had foretold just such a covenant. See Heb. 8:8-13, and especially v. 11.

v. 27 As great a claim as in Matt. 28:18. Revealed religion is the word. Actually, Jn. 1:1-18 has this same thought. See Jn. 5:20ff.; 12:44-50; 15:22; etc.

v. 28 If v. 27 is true, v. 28 naturally follows.

Labor—Does He have in mind the idea in Matt. 6:19-34 (i.e., the unnecessary struggle for "things")?

Heavy-laden—like those spoken of in Matt. 23:4; Acts 15:10?

v. 29 Notice the personal touch: "I," "my," "you," "your," etc. Teamwork gets the job done easily, Jesus says.

Yoke: submission. See Matt. 10:39; 16:24-27, etc. But we invariably serve someone, Joshua reminds us in 24:15.

v. 30 Not heavy as men bind upon us, but light.

QUESTIONS

246. Does Jesus personify the cities (i.e., is He really referring to people who live in the cities)?
247. Does He say that being in a state "more tolerable" than others keeps one out of hell?
248. What sort of claim does Jesus make for Himself in v. 27?
249. Who do you know among men who could offer what Jesus does in vv. 28-30? Who is capable of handling all your problems, plus those of your neighbors and the other three billion people now alive?

(3)—Luke 7:36-50

Luke

- v. 36 *Sat*—Greek is *kateklithē*, reclined and was lying on one side. This was the normal custom of the day. They did not sit on chairs as we do. See v. 38.
- v. 38 *Alabaster*—a fine-grained gypsum, like onyx, mostly from Egypt. Used to contain such as myrrh, etc. See Jn. 12:1ff.
- v. 39 Surely this man (Jesus) is an imposter—any prophet would know what this woman is and refuse to allow her to touch him, Simon thought.
- v. 41 *Denarii*—probably a day's pay, Matt. 20:1ff. So 500 day's pay to 50 day's pay.
- v. 44 Simon may have invited Jesus to dinner, but he really thought so little of his guest that the common courtesies were not extended.
- v. 47 Simon did not think he needed forgiveness.
- v. 49 Some were perceptive enough to consider that Jesus claimed to be a whole lot more than just a prophet.

QUESTIONS

249. If the Pharisee was so insulted by the woman's presence, how do you suppose she got in?
250. What does the word "sinner" mean on the lips of a Pharisee?
251. How much did Simon really think of Jesus?
252. Did Simon think he needed a physician? (cf. Matt. 9:12).

Second Galilean Tour (1), (2)—Matt. 12:22-45;
Mk. 3:19b-30

Matt.

- v. 22 Sometimes demon-possessed people were afflicted other ways, as was the case here. See Matt. 9:32-34; 17:14-21; Lk. 11:14; Acts 16:16-18. However, people with demons were also distinguished from others, as in Matt. 4:24; 10:8; Mk. 1:34; 3:11; Lk. 4:31-36; 40:42; 10:17.
- v. 24 Hard-hearted, like those in Mk. 3:5.
- v. 26 Obvious, except to those who had closed their eyes so that they could not see. Matt. 13:15.
- v. 27 *Sons*—either natural or of same persuasion, probably the latter. See Matt. 23:15.
- v. 28 As obvious as principle in v. 25. He will then argue that this conclusion is the only valid one.
- v. 30 The argument is now turned upon them, and their character is the subject of discussion, since they have said and done things, too.
- v. 31 *Blasphemy*—see Acts 26:11. It means a decision against a certain doctrine, opposition to it in thought, then expressed in word. Thus Paul attempted to make Christians "change thought" about Jesus, and recant their faith in Him.

NEW TESTAMENT HISTORY: THE CHRIST

- v. 32 True in any age: forgiveness only comes through faith in God, not opposition to Him.
- v. 33 Clearly teaches that a person determines what his life will produce, and it is ultimately discernable what the person has chosen. Ref. now Matt. 7:15-20.
- v. 34 Shades of John the Immerser!
- v. 35 The characters of Jesus and the men opposing Him are clearly seen in this text, or what kind of tree (v. 33) and treasure they had. See Matt. 15:1-20; Mk. 7:1-23.
- v. 36 *Careless*—argon in Greek; not 'working,' 'idle,' 'useless,' 'ineffective.' Put brain in gear before releasing clutch on mouth.
- v. 37 Not exclusively, but certainly inclusive of them.
- v. 38 As if they had not just seen one—see ch. 16:1-4; Lk. 11:29.
- v. 40 The resurrection was the only sign that saved. For discussion of three days and three nights, see # 72 (15).
- v. 41 The men of Nineveh were real, and repented at the preaching of a real personage.
- v. 42 *Queen of Sheba*, II Chron. 9:1-9.
- v. 43 Beware of neutrality! Impossible to maintain the empty life empty. See Eph. 5:18.
- v. 45 The people, as a rule, were determined not to choose. But such a choice meant they did choose.

Mark

- v. 20 *Beside Himself* (Greek exeste), normally translated "amazed."
- v. 21 See John 8:48ff.
- v. 30 Unless they change their minds, they are against Jesus.

QUESTIONS

253. List the sickness or physical afflictions of people who were possessed by demons.
254. How many demons are there? (Remember, the Greek word is daimonion, or other forms of it, which is incorrectly translated in the King James version as devils. There is only one devil, known to us as Satan, the deceiver.) See v. 45 for a start, then read Mk. 5:9.
255. Jesus could have 1) been deceived into thinking demons existed, when they really did not, 2) could have known demons did not exist, but went along with the people who thought they did exist, or 3) could have known demons and Satan were realities, and so taught. Which do you think He did?
256. Does Jesus state what blasphemy against the Holy Spirit is? If not, how do we know what it is?
257. Do you (normally) say what you think (i.e., what you believe to be true)?
258. Will we be "spirit-possessed" one way or the other (either by the Holy Spirit or an evil spirit)?

(3)—Matt. 12:46-50; Mk. 3:31-35; Lk. 8:19-21

The passage in Luke is not considered necessarily as having occurred at the same time as Matthew and Mark's accounts, but is placed here for study together, since the same discussion applies to all.

Matt.

- v. 46 Apparently still very much interested in Jesus. No mention of either Joseph or the sisters.
- v. 48 A good question for Christians to ask, not only in respect to other people who may be in Christ, but in respect to their physical families. Both areas and the relationships in each must be considered.

NEW TESTAMENT HISTORY: THE CHRIST

- v. 50 A more enduring relationship than the natural relationships of the flesh. (Human) blood is not thicker than (baptismal) water.

Luke

- v. 21 Note the emphasis on "do" (Greek *poiountes*, a constant life of obedience).

QUESTIONS

259. What happens to all earthly relationships?
260. If we want to remain with our natural relatives forever in a place of bliss, what must be true of all of us?

(4) & (5)—Matt. 13:1-62; 8:18-22;
Mk. 4:1-34; Lk. 8:4-18; 9:57-62

Matt.

- v. 2 Several times, Mk. 3:9; Lk. 5:3, Jesus needed to get far away enough from the people to teach them.
v. 4 So does God's sower and seed work today—as every preacher soon learns, not all he says will find a place to grow. The places of reception vary as much as the soils in the parable.
v. 11 Whether Jesus means only some could know, or only some had thus far had a chance to know, or only some wanted to know, is hard to decide.
v. 12 Interest will determine reception. No neutrality is possible, though.
v. 14 Isa. 6:9-10.
v. 15 Notice that the closed ears and eyes were that way because the possessors willed it to be so.
v. 16 The difference was willingness.
v. 17 The value of the message they had received was tremendous.

SECOND YEAR MINISTRY

- v. 18 The only sure interpretation of any parable is that given by the speaker. No parable is given to prove any doctrine nor should they be so used. Parables, as all figures of speech, are but to illustrate.
- v. 19 Notice that in the explanation, the point of the parable centers upon the hearer, not the sower or seed.
- v. 24 The point of the parable: the inability for anyone to determine the character of another person absolutely. God alone can do that. Appearances are so deceiving. See II Sam. 16:7.
- v. 28 The devil is a sower, too.
- v. 30 A person's character will determine ultimate destiny.
- v. 31 Little is much if God is in it.
- v. 32 *Smallest*: perhaps among the things with which they were familiar.
- v. 33 *Leaven*—does not always mean evil or wickedness. It illustrates a principle that little affects much if the circumstances are right. See James 3:1-12.
- v. 35 Psalms 78:2. The Psalmist however had prophesied of a coming kingdom which God had planned when the world began. The kingdom is the church, and it is the fulfillment of an eternal purpose. See Eph. 1:3-12.
- Foundation of world*—see also 25:34; Lk. 11:50; Jn. 17:24; Eph. 1:4; Heb. 11:11; Rev. 17:8.
- v. 37 The several points of the parable boil down to this: God and Satan are at war, and evil is aided by Satan. In the end, God is the victor, as the Book of Revelation teaches. Evil exists, God alone can judge, and final judgment is sure.
- v. 42 No annihilation for the wicked. See v. 50.
- v. 43 See Daniel 12:1-4.
- v. 44 The ethics of the man may have been quite all

NEW TESTAMENT HISTORY: THE CHRIST

right if we knew the total circumstances. However, the point is that of the pearl: the kingdom is worth any exchange.

- v. 46 A life-long search for the best—and the kingdom is the best.
- v. 49 Much like the principle illustrated in the parable of the wheat and chaff. The spiritual world is “real,” the people who deny it notwithstanding. The whole Bible is built upon that premise.
- v. 52 Point: various methods may and can be used by the one who sows the seed of the kingdom.

Mark

- v. 9 Since Jesus was not just telling them what they already knew, He expected them to apply the principles of what they had heard to another area in life. Since Jesus gave it, the first choice was to consider Him or what He had been teaching.
- v. 12 No seeing or hearing: no repentance and no forgiveness. Do not isolate this text from the total framework of the Bible. The parable explained shows that the hearer is the one who determines the results.
- v. 17 God allows all to be tested. See Rev. 2:10b for the ones who get the reward.
- v. 19 Human nature does not change.
- v. 21 This parable is not found in Matthew, only in Mark and Luke. However, very similar thoughts are found in Matt. 5:10-16; 10:26.
- v. 22 See John 3:18-21; Rev. 20:11-15.
- v. 25 Like Matt. 25:14-30. God makes every person a steward of some things. See Mark 13:34-37.
- v. 26 This parable found only in Mark. It illustrates, as does the leaven and the mustard seed, principles of growth, which even if unknown or only partially

SECOND YEAR MINISTRY

so, yet can be used and made productive. See the same sort of principle in Jn. 3:3-8.

- v. 27 Our responsibility is: sow the seed!
- v. 30 The point of a parable: a comparison.
- v. 34 Because they would be householders who could use the known to explain the unknown.

Luke

- v. 1 Describes the general tour in progress, and a part of one day's teaching follows.
- v. 2 Mary may have gotten her name from the city of Magdala, but that is only speculation. She is not the same woman as in Luke 7 or John 12.
- v. 3 Joanna and Mary are at the tomb, Luke 24:10. Joanna's husband is not otherwise mentioned that we know. Then, as now, evangelization takes money.
- v. 4 *Town after town*—perhaps a big crowd even by today's standards. Certainly interest was great.
- v. 12 *The devil*: like the angels and God: real personalities.
- v. 18 See the connection with Mark, v. 12. The listener turns "on" or "off" as he chooses.

QUESTIONS

- 261. How did Jesus expect people to relate parables to something when He did not teach except in parables? or did He? Was the parable of the sower, seed and soils, the only one He spoke to the crowd? If not, what subject did He introduce in some of the other parables not mentioned in the first one of the sower?
- 262. Does Mark tell you when the disciples ask about the meaning of the parable?
- 263. What does Jesus mean by an "honest, good heart?" (Luke v. 15). Were the men in Matt. 12 in the

- synagogue or those who accused Jesus of being in league with Beelzebul exhibiting an honest, good heart?
264. Should we wait for a complete understanding of the power of God's word before we attempt to be a "sower?"
265. Is it the proclaimer of the word or the nature of the seed, or the soil that determines the actual product?
266. Did Jesus speak in parables to fulfill Psalms 78:2, or did He fulfill it in so doing? (Did He inspire Psalms 78:2 to be written as a prophecy?)
267. Who is the Son of Man in Matt. v. 41? What is claimed for this person (or taught about him)?
268. Will all people without exception be saved?

Matt. 8:18-22; Lk. 9:57-62

These two incidents, somewhat alike, are given here for the sake of parallel study. It is not claimed that they either occurred at this particular time or that they are necessarily accounts of the same incident.

Matt.

- v. 18 *Other side*—much like the account in Matt. 14:13; Mk. 6:30-31.
- v. 20 Perhaps Jesus could see (as He "saw" the thoughts of other men, Mt. 9:4) that the man was not truthful.
- v. 21 Earthly relationships are God-ordained, but they must be kept in place with all others. See Mt. 19:37; Lk. 14:26ff.
- v. 22 *Dead . . . dead*—rather clearly not speaking of people annihilated. See Selected Study on Death.

Luke

- v. 57 Doubtless Jesus had many opportunities to teach

SECOND YEAR MINISTRY

while traveling, but very few incidents are recorded of Him doing so. See Lk. 19.

- v. 60 Maybe the man was offering excuses. We do not know how well Jesus might have known these people, not to mention that He "knew" them anyway, Jn. 2:24-25.
- v. 62 Looking back—(Greek *blepōn eis ta opisō*—'habitually watching the things behind').

QUESTIONS

269. Does Jesus really not want people to even bury others, especially their own family? Did not the 5th commandment yet apply to the one man and his dead father?

31. Sea of Galilee—Matt. 8:23-27;
Mk. 4:35-41; Lk. 8:22-25

Matt.

- v. 23 He had been interrupted by the man's question in v. 18.
- v. 24 Because of its particular geographical location, storms were quick and violent.
- v. 25 They wanted Jesus to do something, but were amazed and afraid when He did it?!? Note that some were saying, "Lord," others "Master," but none believed totally that Jesus was what they called Him.
- v. 26 Were the disciples like others—only believers in Jesus up to a point?
Rebuked—an order! as if the world were in His hands, no less. Well . . . ?
- v. 27 They had much to learn, but this was the first recorded instance of this type miracle.

NEW TESTAMENT HISTORY: THE CHRIST

Mark

- v. 35 *Evening*—opsias, the same word as in 11:11, also Matt. 26:20.
- v. 36 Note the other boats along, perhaps with part of the 12 in them, or others besides the 12.
- v. 37 The situation was getting out of hand: water in the boat rather than the boat in the water.
- v. 38 The only recorded time of Jesus sleeping.
- v. 39 He commanded the wind to cease, and said to the sea, "Siōpa, pephimōso"—"cease, and stay that way!" (from siōpaō, to stop speaking, or be quiet, as in Mt. 26:63; Acts 18:9; and phimoō, 'muzzle' or 'be silenced,' as in Mt. 22:12, 34; Mk. 1:25; I Tim. 5:18.) Luke says the waves were raging.
A great calm—everything obeys its Lord except mankind.

Luke

- v. 23 He had need of rest as every human. Notice His concern for the disciples a little later, Mk. 6:30-31.

QUESTIONS

270. What connotation do you think the disciples had of the word "lord" with which they addressed Jesus?
271. Why would seasoned fishermen be so frightened?
272. Isn't the word "man" in Matt. v. 27 getting a new dimension in the apostles' minds?

32. Gergesa—Matt. 8:28—9:1; Mk. 5:1-20;
Lk. 8:26-39

Matt.

- v. 28 Matthew notes two men, Mark and Luke report about the one man, apparently the more exceptional one of the two.

SECOND YEAR MINISTRY

Tombs—probably dug out of rock hillsides, as were many tombs in that day. Often whole families used the same large rock-hewn tomb, which might have several compartments in it for bodies.

- v. 29 Demons invariably recognized Who Jesus really was, just as He taught their reality.
- v. 30 Jews were forbidden to eat pork (Lev. 11:1-7), and thus did not keep them as a normal practice. However, this region was inhabited by many Gentiles, and the swine may have belonged to them. It is not impossible that the Jews in the vicinity may have been ignoring the O.T. prohibitions.
- v. 31 The demons recognized Jesus' power—but why they wanted to inhabit the swine is anybody's guess.
- v. 32 Jesus only commanded the demons to depart (note Luke v. 29) from the man (men). He did not command them to either go in the swine nor abstain from so doing, though He allowed the option of so doing.
- v. 33 The herdsmen probably set a record time for distance travel.
- v. 34 *All the city*—we are not sure what city, since several cities (towns) were in the neighborhood.
- 9:1 Jesus acceded to their request, and went back to Capernaum.

Mark

- v. 1 Jesus apparently often went to the region on the east side of the sea, since it was cattle country, and considerably less people lived there. See ch. 6:31-35 which events occur just north of the area of our immediate text.
- v. 4 It is not said whether the demon gave this super-human power, or if the man, being out of his mind at times, just simply had broken every attempt until men gave up in fear.

- v. 5 Doubtless his parents were bewildered at what to do.
- v. 6-7 Note that sometimes the man spoke, and sometimes the demons were speaking, though as one.
Permitted them (Greek epitrepō, 'to allow' or 'permit', as in Mk. 10:4; Lk. 9:59, 61; Jn. 19:38; Acts 27:3; I Cor. 16:7; I Tim. 2:2; Heb. 6:3.)
- v. 15 God always does such for people: right both inside and outside.
- v. 18 No wonder the man did—how grateful he must have been.
- v. 20 The area needed the witness. Not many months hence, Jesus will feed over 4,000 people in this area.

Luke

- v. 27 *No clothes*—nothing could control him, nor was he self-controlled. Such is in reality the state of all people who are not possessed by Jesus, and thus possessed by Satan and the demons.
- v. 28 *Most High*—Sometimes used in the O.T. for God. See Psalms 21:7 as an example.
- v. 31 *The abyss*—Unknown as to what they meant. We can speculate that they might have had something in mind like is mentioned in II Peter 2:4; Jude 6, or Revelation 9:1, but it is only speculation.
- v. 37 Like Peter in ch. 5, and the men on the sea just before this event.

QUESTIONS

273. How do evil spirits live in people? For that matter, since you are a spirit, how do you live in your body? Where? Can the Holy Spirit occupy the same body at the same time as you do? See Jn. 14:23.

SECOND YEAR MINISTRY

274. Do you think Jesus foreknew that the swine, demonized, would rush down into the sea and drown?
275. Why do you suppose the people did not want Jesus to stay and heal others?

McGarvey's *Four-Fold Gospel* has a good summarization of Bible information on demons (page 167) which we present basically as he gave it:

- 1) O.T. legislation assumed the existence of "familiar spirits," Lev. 19:13; etc.
- 2) The N.T. as well recognizes their reality, James 2:19; etc.
- 3) Those possessed with demons are distinguished from those with diseases, Mt. 10:8; Lk. 10:17-20.
- 4) They were addressed and responded as persons, Mk. 5:8; 9:25.
- 5) They manifest traits of personality, as desires (text) plus ability to think and reason, James 2:19.
- 6) They exhibit a superhuman knowledge of Jesus, Mt. 8:29.

He then remarks that to regard demon possession as mere disease is simply to disbelieve the Bible.

33. Capernaum—Matt. 9:18-26; Mk. 5:21-43;
Lk. 8:40-56

Matt.

- v. 18 Note that Mark records the fact that Jesus had recrossed the sea, and was talking to a crowd that had gathered.
- v. 19 When the synagogue ruler first arrived, his daughter, age 12, was yet alive (at least to his knowledge). However, Matthew does not record this fact, nor that others came and informed him that she had died (Mk. v. 23 shows she was near death

when he left) after he had left. Hence, the man's second request is given by Matthew, not only that she has reached the end, but that no more hope remains.

- v. 22 Matthew summarizes the account, telling only the essential or basic details.
- v. 23 Probably hired musicians and mourners, at least in part,
- v. 24 To Jesus, no more problem than someone asleep is to us.

Mark

- v. 22 His faith is good, but it does not match that of the Roman centurion in Mt. 8, Lk. 7.
- v. 23 *The point of death* (Greek *eschatōs echei*, having the last things, final moments, etc.)
- v. 24 So the reason for Peter's remark in v. 31 (see Lk. v. 45): great crowds went along. One can imagine in those narrow streets with no sidewalks, and people jostling to go with Jesus, and others trying to go "against the grain," how easy to be touched.
- v. 26 She, like Bartimaeus and others, knew nothing but disappointment.
- v. 28 How she arrived at such a conclusion is only guesswork, though quite true, as it turned out.
- v. 29 She knew. . . .
- v. 30 Jesus also knew.
- v. 31 Luke identified Peter as one of those who so said.
- v. 33 What a paradox she was—great faith that Jesus could heal her, and afraid to come admit that He had.
- v. 34 *Disease* (Greek: *mastix*, an affliction, disease, or ailment, or in the verb form, to inflict punishment, etc. See Mt. 10:17; 20:19; 23:24; Mk. 3:10; 10:34; Lk. 18:33; Jn. 19:1; Heb. 12:6.)

SECOND YEAR MINISTRY

- v. 35 Imagine how Jesus felt!
- v. 37 The inner three. Perhaps no one else was along of the other 12, however.
- v. 39 They may have thought like Jairus (Mary and Martha, etc.): Jesus only could help while the girl was living.
- v. 40 *They laughed*: short lived!
- v. 42 *Immediately . . . immediately*—a characteristic of Mark's gospel.
- v. 43 If she had been sick, this would be reassuring to any parent to see their child eating.

Luke

- v. 42 Only (Greek monogenēs, as in Jn. 1:14, 18; 3:16; etc.).
- v. 45 Luke alone records that no one would admit to having touched Jesus.
- v. 46 The nature of the "touch" is identified.
- v. 47 So she comes to admit the act, recounting in some detail her need and faith.
- v. 50 Much the same expression as found in John 11 to the disciples, Martha and Mary.
- v. 53 Life had ceased as they knew it.
- v. 55 The animating force of the physical body: the spirit, James 2:26. The spirit has life (soul) and when joined to a material body, we become a part of humanity.
- v. 56 Though they were to tell no one, the girl herself would be a self-evident testimony.

QUESTIONS

- 276. How many daughters did Jairus have?
- 277. Why was he beseeching Jesus?
- 278. Was the woman at the "final things" too, even as the young girl?

NEW TESTAMENT HISTORY: THE CHRIST

279. What made her think Jesus' garment could heal?
(See Acts 5:15; 19:11-12.)
280. Are all "touches" alike?
281. To whom was the child dead? to whom was she not dead?
282. Why speak to her as if she were alive?

Matt. 9:27-38

Matt.

- v. 27 *Son of David*—the Messiah in Scripture (See Matt. 22:41-45).
- v. 30 *Sternly charged* (Greek *embribaomai*, 'to severely warn' or 'rebuke').
- v. 31 And the blind came seeing . . . and to see is to believe.
- v. 33 See Mt. 12:22ff. Perhaps a different group of people.
- v. 34 Same song, second verse. It is not hard to see why Jesus called them hypocrites.
- v. 35 The people were much in need of good news, and Jesus felt a compulsion to go, Lk. 4:42-43.
- v. 36 It is ever so with men. God often called the ancient shepherds of Israel to task for their indifference to their flock, Ezek. 34:1ff. See also Jn. 10:16.
- Harassed* (Greek *skullō*, originally to flay or skin, then to rend or tear, so then troubled and bothered).
- Helpless*—heavy laden, no 23rd Psalm for them!
- v. 37 So Jesus will soon send out the 12, then the 70, then the whole church, because the condition is always the same.
- v. 38 And expect to help answer the prayer!

QUESTIONS

283. Do you suppose the men felt a sudden nervousness upon hearing Jesus' question in v. 28?
284. Were the Pharisees blind to Jesus' ability or jealous?
285. Does the healing of the blind men and the man with the demon, along with the concern over lost sheep scattered everywhere sound like the "devil's helper" at work?

34. Nazareth—Matt. 13:54-58; Mk. 1:1-6

Matt.

- v. 54 Nazareth and vicinity. Perhaps this is the same thing as is meant in John 4:43-45.
- v. 55 It is called "poisoning the well" (i.e., disparaging the person so that the things said or done are not judged on their own merits).

Carpenter (Greek tektōn, a skilled workman) perhaps of wood, but just as possible of stone, etc.

- v. 57 The natural result of their thinking.

Offense—they stumbled and fell in unbelief. (Greek skandalizō.)

Mark

- v. 2 Mark identifies the occasion Matthew leaves unnamed: a synagogue service.
- v. 3 *Carpenter's son*—is Joseph still alive?

QUESTIONS

283. Do you suppose they remembered Jesus' birth and boyhood?
284. Is it possible to be so biased as they were?

35. Third Galilean Tour—Matt. 10:1—11:1;
Mk. 6:7-13; Lk. 9:1-6

Matt.

- v. 1 Matthew's account follows from 9:35-38 where Jesus has expressed the need for workers. Distinction made between demons (unclean spirits), disease, infirmity.
- v. 5 A limited mission as a starter. The men needed to learn the business a little before traveling out into the world. Good principle for anyone planning to do mission work.
- v. 7 The participles in Greek are not optional: they were to go, and to speak.
- v. 8 Principle of mission work: don't charge, but expect support.
- v. 10 No extras, just whatever is essential.
- v. 11 The reception will vary—plan accordingly.
- v. 14 Don't stay where no one will receive you—go on where others do want to receive you.
- v. 16 Someone has suggested: highest intelligence and purest motives is what Jesus meant.
- v. 17 The text does not record that this happened on this tour, perhaps it did. But future work would bring such as Jesus predicted, and they could trust God to care for them.
- v. 19 *Do not be anxious . . .* as in ch. 5:25; Lk. 10:41; Phil. 4:6.
- v. 21 See v. 34-35.
- v. 22 Only good soil produces a crop worthy of a reward.
- v. 23 In a short two years, the kingdom would be upon all Israel and the world, and they would usher it in in actuality. Now it was just "at hand," and the king yet in the "wings."
- v. 24 Jesus will often reiterate this, as in Lk. 10:16; Jn. 13:16; 15:20.

SECOND YEAR MINISTRY

- v. 25 Matt. 5:11-12; Lk. 6:22-23.
- v. 26 God sees all—and He will justly deal with all. Besides, vengeance has no place in the disciple's life. See Matt. 5:38-42; Rom. 12:19-21; II Tim. 4:16.
- v. 28 God alone is worthy of fear. Jesus can help us overcome everything including the prince of this world, the devil.
- v. 32 God takes care of everything: sparrows, hair, you. Just make sure you affirm your loyalty to Him.
- v. 33 God knows how we stand at any given moment.
- v. 34 Peace is only the property of the individual disciple. God does not promise peace (i.e., a right relationship with Him) except to those in Christ, Rom. 5:1.
- v. 37 We are to love natural family, but not more than God and those who are His. See I Jn. 3:10, 14-18.
- v. 38 One can not keep his life for self—if he does, even that which he has will be taken away, Matt. 25:29.
- v. 41 Each one is judged individually, against himself, not others.
- v. 42 Nothing is of no consequence in the kingdom.
- 11:1 The tour continues, Jesus going His way, they theirs.

Mark

- v. 7 One of the reasons people were amazed at Jesus was His power to do what men could not do. The principle pointed out in 12:28-29 is most important to this end: men are not stronger than Satan . . . only God is.
- v. 11 The disciple was himself to determine how long he should stay. One of the options in missionary work, or any work in the kingdom.
- v. 13 *Anointed with oil*—the cultural custom. See Lk. 10:34; James 5:14.

Luke

- v. 1 Power and authority (Greek *dunamis* and *exousia*, as in Rom. 1:16 and Matt. 28:18.) Power is the moving force, authority the privilege to exercise it.
- v. 6 *Preaching the gospel*—as yet not quite the connotation of I Cor. 15:1-4.

QUESTIONS

285. How do the accounts invariably identify Judas Iscariot?
286. List the 12 apostles, with all their various names.
287. Why the limited commission to only the house of Israel? Did it have to do with the nature of the kingdom at that particular moment as well as the lack of experience of the disciples?
288. How would they decide if a house was "worthy?" Would such people be making a confession one way or another?
289. Why would they be allowed to be hailed into court? (See Acts 9:15-16; 26:16-18.)
290. Is the life Jesus lived a pattern we may well expect in our own life?
291. Does God know all of your cares and needs? Will He also know who puts Him first?
292. Was it important to warn the disciples about the coming opposition and also God's awareness of any and all they do for Him?

Matt. 14:1-12; Mk. 6:14-29; Lk. 9:7-9

Matt.

- v. 1 *Tetrarch*—ruler of a fourth part in classical Greek, as with the rulers of the four parts of Thessaly. Herod was a son of Herod the Great. He was

SECOND YEAR MINISTRY

known as Antipater (Antipas) and as Herod the king (see Mk. v. 14).

- v. 2 Herod's imagination was as great as the power he thought came through reincarnation!?!
- v. 3 Herod Philip's wife, Herodias, had left him (her uncle) for Herod Antipas, the uncle's half-brother.
- v. 6 *Danced*—(Greek *orcheomai*, as in Mt. 11:17; Lk. 7:32). Like a common almeah, 'dancer'.
- v. 7 Not many women literally want a man's head cut off when they dance, just figuratively. She already had Herod's head.
- v. 9 Sorry—and how!

Mark

- v. 15 Note the same ideas in Matt. 15:13ff., and Jn. 1:19ff.
- v. 18 John knew what the O.T. law was.
- v. 20 *Herod feared*—because the people feared John as a prophet, and Herod feared the people.
- v. 23 Herod had lost his head!
- v. 25 *At once*—Herodias was afraid the opportunity would slip by for which she had waited so long.
- v. 26 Pride precedes destruction—Herod lacked the moral courage to right a wrong oath.

Luke

- v. 7 *Perplexed*—Herod thought he had really goofed in beheading John.
- v. 9 Two years later, at the trials, Herod did see Jesus, ch. 23:6-12.

QUESTIONS

- 293. Who was this Herod? Who was his wife?
- 294. Why was Herod reluctant to kill John?
- 295. Do you think a person ought to keep what is vowed

regardless of anyone or anything? (How would Matt. 7:12 or Lk. 4:8 apply here?)

296. Was Salome any better than Herod or Herodias?

36. Across the Sea—Matt. 14:13-21; Mk. 6:30-44;
Lk. 9:10-17; Jn. 6:1-14

Matt.

v. 13 Jesus had feelings, too.

v. 14 See 9:36, Mk. 6:34.

v. 15 The disciples came with a problem, and started giving orders.

v. 19 *He looked up to heaven . . . gave thanks . . . and gave*—a good example for us.

Mark

v. 30 Doubtless excited and yet debilitated after the tour.

v. 31 The lonely place was up in the hills (Jn. v. 3.), and probably on the north east side of the Sea of Galilee. Luke's Bethsaida (v. 10) is probably Bethsaida Julius, on the east side of the mouth of the Jordan River, and not the Bethsaida near Capernaum, Mt. 11:21.

v. 33 Perhaps some were from other places, and had not had the chance to be around Jesus.

v. 34 Wonder if they thought Jesus did not know that?

v. 37 So Philip had reckoned, Jn. v. 7.

v. 39 They were told to sit down (Greek work anaklinō means 'lie down,' or 'recline' as the usual custom was) in companies in orderly fashion.

Companies—(Greek sumposion, sum 'with' and pinō 'to drink,' a drinking party originally. Then, any group gathered together.)

v. 40 *Groups*—(Greek prasia a 'garden-bed'). So the re-

SECOND YEAR MINISTRY

clining was in orderly groups much as an orderly garden plot.

v. 42 *Satisfied*—(Greek *chortazō*, to fill up, or be satisfied, as Mt. 5:6).

v. 44 Now we get some idea of the size of the crowds following Jesus. No wonder the disciples and Jesus had no leisure to eat even, v. 31.

Luke

v. 12 *The day began to wear away* (Greek *ērxato klinein*, 'began to recline')—the sun was nearly down and the kids were getting both tired and hungry. Food was gone (note that they had 12 empty baskets to pick up the scraps).

v. 16 See I Tim. 4:4-5.

John

v. 4 The second Passover specifically mentioned by John. He mentions three by name, ch. 2, 6, 13. The Synoptics mention this one by inference and the last one by name.

v. 8 The other accounts record that Jesus sent them to see. Andrew found the lad.

v. 10 Matthew says *grass*, Mark *green grass*, Luke does not remark about it. John has *much grass*. So: much green grass, or pasture land.

v. 13 *Baskets* (Greek *kophinous*. See on 15:37).

v. 14 John prepares us for the effort in v. 15.

QUESTIONS

297. Do we really know how much ministering Jesus did?

298. Jesus knew His disciples and wanted them to rest. Does He also know we need rest (other than sleep) along with work?

299. Is there profit in relaxation and meditation?

300. Why bother to pick up the scraps?
 301. Do you suppose that the people had conversation with the disciples (while the distribution of food was taking place) about the possibility of Jesus being King? Do you think the apostles, fresh from a tour, might have had some great ideas about the power of Jesus (not to mention the fact that they keep going back and getting bread and fish from the five loaves and two fishes with which they started)?

37. On the Sea—Matt. 14:22-33;
 Mk. 6:45-52; Jn. 6:15-21

Matt.

- v. 22 Just as soon as the scraps were gathered, Jesus did these things: 1) dismissed the multitude of 5,000 plus, 2) made the disciples get in a boat and leave (apparently to get them apart from the crowds) and 3) went off by Himself away from the crowds and the disciples.
- v. 23 *To pray*—perhaps because He had been presented with the temptation to become something other than what God wanted, a temptation not unlike that in the wilderness two years earlier.
- v. 25 *Fourth watch*—probably 3-6 a.m., which meant they had been on the sea some 8-10 hours.
- v. 26 *Saw him*—perhaps they did not recognize the figure they saw as being Jesus, but rather just saw a semblance of something or someone.
- Ghost*—so we would understand. The Greek term (phantasma) is seen in our word “phantom.”
- v. 28 Matthew alone records the incident with Peter.
- v. 29 God may grant any request we make—be careful what you ask of Him.

THIRD YEAR MINISTRY

- v. 31 *Little faith*: acceptable to God, but not pleasing.
doubt (Greek edistasas: pulled two ways, i.e., torn in two, as mentally, etc.).
- v. 32 *Worshipped*: Jesus never refused worship. He accepts it as if it were His due. If He had been knowledgeable of the 1st commandment (and we assume He was), but a Jew and not God's Son, this acceptance of worship would have been summarily rejected. However, if all the disciples were worshipping, Mark, v. 52, tells us that their hearts were rather hard either before Jesus got in the boat or afterward. Matt. 16:5-11 seems to indicate that they really did not understand the full implication of what Jesus did.

Mark

- v. 45 *Bethsaida*—probably the place on the west(?) side of Capernaum.
- v. 48 *He saw*—God always knows our problems.
Distressed (Greek basanizomenos, "tortured," "tormented" or "treated as slaves," etc.).
Pass them by—Jesus wanted to help, but they needed to ask.
- v. 50 *It is I*: Greek egō eimi, as in Jn. 8:58).
Have no fear (Greek mē phobeisthe: Quit being afraid).
- v. 52 *Hearts hardened*—God has decreed that a failure to accept the obvious conclusion to a certain group of facts (in this case, the feeding of 5,000 plus) will bring about a hard heart. Of course, the expression "hard heart" is to be understood in the religious sense only.

John

- v. 15 *Force*—Greek reads: Jesus therefore knowing that

they were about to come and seize (*harpazein*) him so that they might make (him) king. The word *harpazein* is seen in Mt. 7:15; 11:12; 12:29; 13:9; Lk. 18:11; Jn. 10:12; 28ff.; Acts 8:39; I Cor. 5:10ff.; 6:10; II Cor. 12:2, 4.

- v. 16 John does not say when Jesus went into the hills, nor His actions toward the crowd or the disciples.
 v. 21 *Land*: Gennesaret, on the upper N.W. shore of the Sea of Galilee.

QUESTIONS

302. Why separate the disciples from the multitude?
 303. Why did Jesus depart into the hills to pray?
 304. What caused Peter's mind to become divided?
 305. If the disciples knew it was Jesus, why were they afraid (or did they know what they saw was actually the person they knew as Jesus)?
 306. Does John imply a miracle by his word "immediately" in v. 21?

38. Gennesaret—Matt. 14:34-36; Mk. 6:53-56

Matt.

- v. 34 John, v. 21, says that the boat immediately arrived at the shore when Jesus got into it. Matthew and Mark simply record the fact that they arrived at the shore.
 v. 35 He had toured the general area of Galilee three times, so they doubtless knew Who Jesus was.
 v. 36 Perhaps the incident of the women in ch. 9 had become known.

Mark

- v. 55 A great testimony to the person of Jesus!
 v. 56 If Jesus walked from Gennesaret the 5-7 miles around the shore of Galilee to Capernaum, perhaps

THIRD YEAR MINISTRY

people ran ahead to alert others that Jesus was coming.

37. Capernaum—Jn. 6:22-71

- v. 23 *Tiberias*—a city on the lower west shore of the sea. The Gospels never record that Jesus went there, or any of His disciples.
- v. 25 *Capernaum*, v. 59.
- v. 26 See Rom. 16:18; Phil. 3:19.
- v. 27 1) Don't work for material things, primarily, in life.
2) Do work for eternal things,
3) Believe the promise from Christ,
4) God has given adequate reason to trust Christ.
- v. 28 Note Paul's expression "obedience of faith" in Rom. 1:5.
- v. 29 Obviously, the ancient controversy over works is continually a problem because the meaning of the word "work" is seldom agreed upon. To believe in Christ is a direct command, I Jn. 3:23, and when we obey it, we do so in faith. If we define a "work" as something we do, then faith is a work.
- v. 31 The reason for reminding Jesus of the manna is that it was God's sign through Moses that the people were to listen to Moses, God's spokesman.
- v. 32 The same basic thought as in 1:3-5.
- v. 34 Like the women in ch. 4.
- v. 35 *He who comes* (Greek *ho erchomenos*)—a constant lifetime habit.
- v. 36 *You have seen me*—just yesterday you did, when you and 5,000 others were fed.
- v. 37 God has made man with the capacity to hear facts, draw conclusions from them, and act upon those conclusions. God gives people to Christ through

His Word, v. 45, Rom. 10:17. However those who hear must believe what is spoken, Heb. 4:2.

- v. 38 See 20:21.
- v. 39 The individual alone can choose to be lost, God does not so will it, II Pet. 3:9.
- v. 40 *Everyone who sees* (Greek pas ho theōpōn)—a constant lifetime habit.
Should have (Greek echēi)—a constant possession based on the two preceding conditions. One must keep obediently steadfast until the end, Heb. 3:14; Rev. 2:10.
- v. 41 *Murmured* (Greek egonguzon, used in LXX, the Greek translation of the O.T., for Israel's murmuring in the wilderness. See also I Cor. 10:10).
- v. 44 All who come to Jesus are drawn through God's message, whether read, spoken or whatever, v. 45.
- v. 45 Salvation in Christ is divinely revealed not man-produced. See Matt. 11:25-27; 16:16-18; I Cor. 2:7ff. See also Isa. 54:13.
- v. 46 Luke 3:13.
- v. 47 The one believing—like v. 35, 40.
- v. 49 Get your mind on spiritual food, not physical! Cf. Mt. 5:6.
- v. 51 Life comes in Jesus' death. He died in our place.
- v. 52 They had the same problem as those who teach that a person must partake of communion that life might be had: mistaking the symbol for the reality. In Christ we have life, not in symbols.
- v. 53 Active, personal appropriation of the life that is in Christ is a must.
- v. 54 *He who eats* (ho trōgōn), (he who) *drinks* (pinōn): both must be lifetime habits. Such persons have (present and abiding) eternal life on the basis of the preceding conditions.

THIRD YEAR MINISTRY

- v. 56 *Abides*: again, a conditional promise on the basis of habitually "eating" and "drinking," i.e., being in Christ.
- v. 58 The quality of eternal life is only from God. Existence is the lot of every person. Eternal life is an option.
- v. 60 A better question: who is willing to listen. As Jesus said in ch. 5:40, the Jews were unwilling to come to Him for life.
- v. 61 *Take offense* (Greek skandalizō:) i.e., caused to stumble.
- v. 63 One has to accept the message from (and about) Jesus to have life. The means God uses to convey truth is in words comprising a message. The truth accepted means life, I Cor. 1:18ff.
- v. 64 *First*: same Greek word as in 1:1 (beginning).
- v. 65 A failure of faith, v. 64, kills all hope of gaining Christ.
- v. 66 They ceased following Jesus—the cost too high. God had spoken through His own Son in their hearing: they willed not to believe.
- v. 67 Note: Jesus implies that the choice was theirs, not God's, as to whether they wished to follow Him. God gives the ability to believe and choose; man does the believing and choosing.
- v. 69 *Holy One*—a title for the Messiah, see Mk. 1:24.
- v. 70 *Devil*: a better translation would be deceiver. The Greek word is diabolos. But see Matt. 25:41; Jn. 8:44; Rev. 20:2.

QUESTIONS

307. Why did Jesus condemn the efforts of the multitude to find Him? Was He right about their real motives (Cf. v. 60, 66)?

NEW TESTAMENT HISTORY: THE CHRIST

308. What was the parallel between Jesus and Moses? Is this the parallel Jesus makes: He is to the spiritual life what bread (food) is to the physical life?
309. Why say that faith is a work?
310. What mistakes did the listeners make about the words "flesh" and "blood," which Jesus clarified in v. 63?
311. Do some men teach that vv. 53-59 refer to the communion emblems just to force people to come to "church services?"

Matt. 15:1-20; Mk. 7:1-23

Matt.

- v. 2 The men considered the elder's traditions as law. Jesus will show how wrong they were. Nothing is wrong with tradition, as long as God's commandments are not voided.
- v. 3 Notice the contrast: tradition, v. 2, versus commandment, v. 3.
- v. 4 Ex. 20:12; 21:17.
- v. 5 They held the vow was more binding than the commandment. Granted that vows were binding, Num. 30:2, but all were ultimately traceable to God, Mt. 5:33-37. Thus God's will came first, before man vowed. Wonder what sharpster figured this little "loophole" out?
- v. 7 *Hypocrites*: in that they claimed to obey God, but rather obeyed men.
- v. 8-9 Isaiah 29:13.
- v. 11 Nothing is unclean of itself. Sometimes God had forbidden, and to eat (or partake) made the person sinful, as well as oftentimes ceremonially unclean. However, let it be said that laws relate to morality which is the real issue here. Ceremonial uncleanness is man's term (and distinction) for certain

THIRD YEAR MINISTRY

conditions such as touching a dead body, etc., which was not sinful within itself, just defiling in relationship to worship, social relationships, etc.

The mouth, the instrument of the heart (mind), v. 18-19.

- v. 12 They were scandalized!
- v. 13 Doctrine can not be separated from teaching, or the one teaching, Lk. 16:16; II Cor. 2:14-17.
- v. 14 They willed their condition, and were quite unwilling to change.
- v. 17 Point: man obeys or disobeys as a total man, not just a physical body. If one disobeys, one is in so doing unclean (defiled) which is the real act that damns.
- v. 19 We hence have no excuse for sin: we willed it to be so.

Mark

- v. 3 A false interpretation was to blame for such needless activity. Washing of hands was doubtless a good thing anytime before eating. Considering such an act as a moral necessity was never good if God had not so spoken.
- v. 4 They totally immersed (washed) themselves, and anything else considered suspect.
- v. 5 *Eat*—implied is that it was a common habit. It probably was, since Jesus well knew and so taught that the law commanded no such thing.
- v. 8 How amazing (or disgusting, depending on one's viewpoint) that tradition is a greater treasure than Scripture. Now read Matt. 23:1ff.
- v. 12 *Corban*—a gift, then a possession dedicated to God (but retained by the giver for personal use only, as here).
- v. 13 *Many such things*: see Matt. 23:33.

NEW TESTAMENT HISTORY: THE CHRIST

- v. 19 So also in I Tim. 4:1-5. It is use or misuse that really defiles. So all things must be considered as a stewardship, to be used as God directs, as in Rom. 12:3-8; I Tim. 6:17-19; etc.
- v. 21 *Evil thoughts*: such as the men in v. 1 entertained against Jesus.
- Licentiousness* (lasciviousness in K.J.) generally perversity of some nature. The Greek word is aselgeia, and generally describes conduct of a shameful nature. See Rom. 13:13; II Cor. 12:21; Gal. 5:19; Eph. 4:19; I Pet. 4:3; II Pet. 2:2, 7, 18; Jude 4. What a cesspool the mind can be!
- v. 23 We are defiled by action (i.e., thought or deed). Only humans are moral beings and capable of defilement. It is not funny to say that defilement is a grave issue.

QUESTIONS

312. Do men yet bind interpretations of God's Word on other people?
313. What could be the result of following men? Of men teaching interpretation as equal to God's Word?
314. Whose interpretation of the Bible is authoritative?
315. Jesus interpreted God's Word: was His interpretation authoritative? If so, why?
316. Who is equal to Jesus today?

40. Phoenicia—Matt. 15:21-28; Mk. 7:24-30

Matt.

- v. 22 *Son of David*: whether she meant what she implied is unknown. Perhaps the reaction of Jesus was meant to test her on that point.
- v. 23 Mark's account relates that she had fallen at Jesus' feet, and begged. Apparently Jesus had not re-

THIRD YEAR MINISTRY

sponded, but had ignored her, though she kept following and "crying after" them.

- v. 24 True, though He had ministered to others often. The reason for the reply was to test her.
- v. 26 Point: she was a part of Jesus' personal mission.
- v. 27 The children's bread (Greek *trapezēs tōn kuriōn*, i.e., table of their lords/rulers. Sometimes *trapeza* is used figuratively of meals, as here or in Acts 6:2, 16:34.
- v. 28 Faith "hung on" in spite of all obstacles.

Mark

- v. 24 Too many people knew Him. See 3:8.
- v. 25 *Unclean spirit*—demon in Matthew.
- v. 27 *First*: the key which the woman used to get her request.
- v. 28 The Greek may indicate that she said ". . . *little dogs*," ". . . *little crumbs*," ". . . *little children*."
- v. 29 The crumbs were hers!

QUESTIONS

- 317. Why go to Tyre and Sidon?
- 318. Why was Jesus unable to keep hidden?
- 319. Does silence indicate either ignorance or indifference?
- 320. Is the women's abiding faith worth a thousand definitions of faith?
- 321. This incident follows the discussion of clean/unclean meats, and morally defiling deeds. Is there any connection (the people in Tyre and Sidon would be considered unclean by Jews)?

41. Decapolis—Matt. 15:29-39; Mk. 7:8-10

Matt.

- v. 29 Mark's account along with Matthew's seemingly

NEW TESTAMENT HISTORY: THE CHRIST

indicates that the men did not stop in Galilee, though passing through, but traveled on into Perea, the Decapolis area. Some months earlier, Jesus had told the man of Gergesa to tell what God had done to Him, Matt. 8.

- v. 30 Mark selected the one man who was healed, while Matthew simply recounts the general healing done by Jesus.
- v. 31 We wonder if the people were Gentiles, or at least part Gentiles.

The God of Israel: whether they recognize Jesus or not, at least they gave God praise. Note Mt. 5:16; Jn. 17:4.

Mark

- v. 33 The accounts show that Jesus healed in many different ways. This is something like the healing in John 9.
- v. 37 See Peter's remark in Acts 10:38. The attitude of the common people was certainly not shared by most of the religious leaders however.

QUESTIONS

322. Do you suppose Jesus wanted to keep out of the jurisdiction of Herod Antipas, thus He stayed in in the areas (like Tyre, and the Decapolis) where Herod had no authority?
323. Does the scripture ever indicate why Jesus healed in different ways, or do we just not really know?

Matt. 15:32-39; Mk. 8:1-10

Matt.

- v. 32 This verse tells us how little of Jesus' ministry is really recorded for us. How many people He must

THIRD YEAR MINISTRY

have healed and how much teaching He must have done on this occasion!

I am willing—The summation of Jesus' life is well expressed in these words: the need of people always drew out the compassion of Jesus.

- v. 33 The disciples did not learn the lesson just a few months before when Jesus fed 5,000 plus.
- v. 36 The same procedure as in the feeding of the 5,000.
- v. 37 *Baskets*—(Greek *spuris*, as in Acts 9:25).
- v. 39 Magadan, probably also known as Dalmanutha. The same general region as Gennesaret.

Mark

- v. 1 Mark's account does not mention why the crowd gathered.
- v. 3 *They will faint, . . . some have come a long way:* the more reason why Jesus was compassionate.

QUESTIONS

- 324. How could Jesus do so many things so very well, and the disciples still not think He could feed the multitude?
- 325. If, as some say, Jesus was the only God, and while manifest in the flesh, was not in heaven, why would He give the appearance of thanking a God in heaven for the loaves and fishes?

42. Magadan—Matt. 16:1-4; Mk. 8:11-13

Matt.

- v. 1 *To test*—the Greek word is also translated "to tempt."
- v. 2 They can easily judge the weather from the signs they see.

v. 3 But signs just as easily observed, which He was doing, were ignored as to their obvious message. Nicodemus was a good example of people who drew the right conclusion from the signs, Jn. 3:2. See also Lk. 12:54-56.

v. 4 They did not need to seek a sign—Jesus had done so very many. John 6:22ff. is a parallel.

Sign of Jonah—as in Matt. 12:38-42; the death, burial and bodily resurrection of Jesus was “the” sign of all signs. This sign was the major piece of evidence for Jesus’ deity.

Mark

v. 11 *Began to argue*—the Greek term used means to dispute, and the tense used implies they kept it up.

v. 12 *Sighed deeply*—(Greek *anastenazō*) Jesus was really “tired” of their hypocritical natures.

Notice that Matthew’s account supplies an additional thought: “except the sign of Jonah.”

v. 13 Toward Bethsaida Julias, or the north-eastern shore of the Sea.

QUESTIONS

326. How did Jesus say the signs in the earth and sky and the signs He was doing were alike (Did they have common characteristics such as the observing eye could discern)?

327. Did the people who observed natural signs give evidence of an ability that could also have been used to observe signs Jesus did?

328. Were the miracles Jesus did not signs (if the resurrection were the only sign)? What did Jesus refer to with the use of the word “signs of these times?”

THIRD YEAR MINISTRY

43. On the Sea—Matt. 16:5-12; Mk. 8:14-21

Matt.

- v. 5 They arrived at the area of the Sea close to the place where the upper Jordan River flowed into the Sea.
- v. 6 *Leaven*: probably refers to the doctrine of the Sadducees and Pharisees, which could influence their lives. What Jesus had in mind is not specifically stated, but is probably their basic doctrines which He often showed were wrong in various ways.
- v. 12 *Teaching*—the means of influence.

Mark

- v. 15 *Take heed*—or “Watch out for . . .”
- v. 17 Their hearts were hardened, sad to say but true.
- v. 21 They had the greatest of teachers in Jesus. Unless a person is willing to hear, however, nothing avails.

QUESTIONS

- 329. What basic position did the Pharisees and Sadducees hold in regard to the Bible (O.T.)? to Jesus?
- 330. What was the lesson the 12 should have drawn from the two miracles Jesus mentioned?

44. Bethsaida—Mk. 8:22-26

Mark

- v. 22 This miracle is found only in Mark's Gospel. Blind people were very common in that day, even as they are in many countries today. Improper (or no) treatment of the baby's eyes at birth often caused blindness.
- v. 24 He had apparently seen before to know the shape of men and trees.

QUESTIONS

331. Why lead the man out of the village and then forbid him to even go back into it?

45. Ceasarea Philippi—Matt. 16:13-28;
Mk. 8:27—9:1; Lk. 9:18-27

Matt.

- v. 13 *Son of Man*—over 80 times in the Gospels, and almost exclusively used by Jesus Himself.
- v. 14 None of the men mentioned could save!
- v. 19 Though spoken to Peter, the rest will be told the same general thing.
- v. 20 Perhaps because they had too many false ideas of what the Messiah was to be, and quite obviously did not understand Jesus' nature.
- v. 21 The nature of the Messiah is outlined.
- v. 22 The R.S.V. translates "God forbid" as do others. Such is a poor translation. A better one would be something akin to "This must not happen to you, Lord."
- v. 23 Another attempt by Satan to use one of Jesus' own friends to deter Christ from His chosen goal. Satan won Judas Iscariot to do his bidding.
- v. 24 *deny*: "as I do, and all who follow Me must do." Not deny things to self, but deny self.
- v. 26 Nothing is profited, since a man can not keep material goods, Lk. 12:15ff.; I Jn. 2:15-17.
- v. 27 The sacrifice of self will, at Jesus' second coming, be worth it. (See v. 28)
- v. 28 The text present a definite problem; did Jesus mean the second coming (as mentioned above under v. 27, and foretold in Acts 1:11) or the inauguration of the church/kingdom on Pentecost. It would seem the latter, since the disciples did not live until the second coming.

THIRD YEAR MINISTRY

Mark

- v. 27 Ceasarea Philippi—some 25 miles north of Capernaum.
- v. 32 *rebuke*—the same word as in 4:39.
- v. 33 Men would surely have changed Jesus' mission to suit themselves. See Matt. 11:12; Jn. 2:24-25; Acts 13:41; 15:15; etc.
- v. 38 Peter's rebuke may have been because he thought Jesus was "above" the things mentioned in v. 31.

Luke

- v. 18 Matthew's account says only that the conversation took place around Ceasarea Philippi. Mark's account specifies while walking towards that general area. Luke pinpoints the time and place to a time and place of prayers, which apparently happened as they traveled north to Ceasarea Philippi.
- v. 20 Matthew's account is the most complete here, while Mark and Luke record only the essence of the statement Peter made.
- v. 22 Jesus makes plain predictions of His passion in the following texts 1) Matt. 16; Mk. 8; Lk. 9, 2) Matt. 17; Mk. 9; 3) Matt. 17; Mk. 9; Lk. 9, 4) Lk. 17:25; 5) Matt. 20; Mk. 10; Lk. 18; 6) Matt. 26; Mk. 14; Lk. 22.
- v. 23 Luke adds the word "daily." The decision is expected to involve a whole lifetime.

QUESTIONS

332. What was the point of Jesus asking the disciples about His identity?
333. Were disciples the only ones who had received a revelation from God about Jesus' identity?
334. How could Peter become Satan?
335. What is the basic idea in losing/gaining, etc.—that of unselfishness?

336. What does "taste" death mean? (Cf. Heb. 2:9.)

46. A High Mountain—Matt. 17:1-13;
Mk. 9:2-13; Lk. 9:28-36

Matt.

- v. 1 Luke's eight days probably tells more exactly the time that elapsed between the discussion about Jesus' identity and His transfiguration.
- v. 2 transfigured (Greek *metemorphōthē*)—changed as in Romans 12:2; II Cor. 3:18. Perhaps the transformation is described by the Gospel accounts, so that we know how Jesus was changed.
- v. 3 The two men with Jesus, Moses and Elijah, have been suggested to be representatives of the law and the prophets. The discussion was about Jesus' death which, as He said, had been foretold in the law and prophets.
- v. 4 booths (Greek *skēnas*, as in Jn. 1:14).
- v. 5 Like the expression after Jesus' baptism. See also Jn. 12:28ff.
- Listen to Him*: rather than Moses and the prophets, in the sense that the new will expressed through Christ was to be the only agreement between God and men.
- v. 6 The people at Sinai reacted much the same way, Heb. 12:18ff.
- v. 7 Since Jesus was with them, they need not have feared as they did.
- v. 9 Peter, James and John must have really wondered during the next six months, not only about the vision itself, but what it meant about the person of Jesus, none of which they could tell. We may see, however, the reason why James and John would ask for special places of honor in the kingdom, ch. 20:20-28.

THIRD YEAR MINISTRY

- v. 11 Mal. 4:5-6 said this. Jesus has to explain that Elijah had appeared in the person of John the Immerser.
- v. 12 *the Son of man must suffer*—as one prophecy was fulfilled, so must another prophecy (in regard to Jesus) be fulfilled. But the disciples missed this part though understanding the part about John, v. 13.

Mark

- v. 2 The other nine men were in the valley below, perhaps in a village or at least near one where their presence was known.
- v. 3 *fuller*—a person who bleaches cloth, etc.
- v. 5 It was about the time for the Feast of Tabernacles during which feast the people were to dwell in booths they made. This may be the genus for Peter's idea.
- v. 10 They could not accept either the fact that Jesus was to die or its meaning.
- v. 13 The men should have drawn the conclusion in a more firm way that Jesus was really the Messiah. All the more reason for faith in Him.

Luke

- v. 29 *As he was praying*—only in Luke. *altered* (Greek heteros, another, different in some way).
- v. 32 Luke only records this fact about the men being sleepy. Perhaps it was night. Sometimes a mountain climb and the thinner air tire one easily, and would cause sleepiness.
- v. 33 *not knowing*—failure to understand the situation. Peter probably thought something ought to be done.
- v. 36 Peter later mentions this very incident in II Pet. 1:16-21 as being evidence for his apostleship and Jesus' deity.

QUESTIONS

337. Can you describe the appearance of Jesus, combining the information in all three accounts?
338. Moses and Elijah would represent what in the minds of the apostles?
339. Who heard God's voice the first time He spoke about Jesus?
340. Why do you think the transfiguration occurred?
341. Were the other nine apostles not ready for the information the transfiguration would give to those beholding it?
342. Did the apostles understand the remark of Jesus in Matt. 11:14?

Matt. 17:14-20; Mk. 9:14-32; Lk. 9:37-43a

Matt.

- v. 14 Luke records that they stayed all night on the mountain, and when they came down from it, the crowd was with the nine.
- v. 16 The man's emotional state is understandable as he speaks of his son's condition and the inability of the disciples to help.
- v. 17 *faithless and perverse*—this seems to be directed to the crowd in general, but it may be that Jesus said it only to the nine, v. 20 and since Mark v. 14, 16 indicate that Jesus first talked with His disciples and, while talking, the man came up with his plea.
- v. 18 Matthew and Luke summarize the proceedings. Mark's account shows that Jesus spoke with the father about the son.
- v. 20 No faith needed on the part of either the father or son, just the disciples. Nothing is impossible with God, only as we limit Him.

THIRD YEAR MINISTRY

Mark

v. 14 The scribes were doubtless scoffing at the disciples and their master, Jesus. It was a high moment for them, at least until Jesus arrived.

arguing (Greek *suzētountas*, as in 8:11).

v. 15 No indication why the crowd was amazed to see Jesus.

v. 18 Perhaps the tour (Matt. 10) of the disciples a few months previous had made them bold enough to brag about their abilities. However, the man may have known nothing about the tour, and just considered that Jesus' disciples might have been able to help.

v. 20 The demon acted as all other demons in Jesus' presence: it recognized Who He was. Read Acts 19:15 here.

v. 22 *if you can*—the father was desperate. However, Jesus shows in v. 23 that the issue is with the father. See Matt. 8:2-5.

v. 25 The demon is addressed as if a real personality, which we assume is so, despite the position some hold to the contrary.

v. 29 Some texts add the words "and fasting." Perhaps the particular demon involved was different than the others.

by prayer—that is, with God's help. No indication that man alone can overcome the devil. See Matt. 12:25ff.

Luke

v. 38 *only* (Greek *monogenēs*, as in Jn. 1:14, 18, 3:16; Heb. 11:17).

v. 39 *shatters*—the same Greek word in a strengthened form is in v. 42.

v. 41 The disciples did not have sufficient faith that with

- God's help (through asking for it) the boy could be healed. Note then their expression in Luke 10:17.
- v. 42 *tore* (Greek *susparassō*, a violent convulsion, Mk. v. 26, which left the boy like dead). See v. 39 "shatter."
- v. 43 *majesty* (K.J. "mighty power." The Greek word is found also in Acts 19:27; II Pet. 1:16).

QUESTIONS

343. Do you think the attitude of the scribes might have intimidated the disciples? (The scribes were against Jesus as a rule.)
344. Where does Jesus pin the blame for the failure? Why did the failure occur?
345. Describe all the things the demon did to the boy.
346. Describe the demon.

Matt. 17:22-23; Mk. 9:30-32; Lk. 43b-45

Matt.

- v. 22 The men went back south to Galilee, to go to Jerusalem for the Feast of Tabernacles.
- v. 23 *greatly distressed*—they could not comprehend because they would not understand.

Mark

- v. 30 Jesus was attempting to remain apart from crowds. See John 7:1ff.
- v. 32 The disciples were afraid, perhaps because He had told them so many times before.

Luke

- v. 44 The *majesty* would soon be forgotten in the crucifixion.
- v. 45 It was concealed primarily because of their blindness.

THIRD YEAR MINISTRY

QUESTIONS

347. List the different times and places where Jesus spoke of His passion, death and resurrection.
348. Did the disciples really "hear" the words "be raised on the third day?"

47. Capernaum (1)—Matt. 17:24-27

Matt.

- v. 24 *half-shekel*: see Ex. 30:11-16. The tax was due in Adar (March).
- v. 25 Jesus spoke to Peter before Peter said anything.
- v. 26 *then* (Greek *ara ge*, "for sure!")
- v. 27 Though logically free, not practically so. Hence, to keep from being an undue cause of stumbling for His disciples as well as for others, Jesus paid the tax.
- v. 27 *give offense* (cause them to stumble, ie., sin). *for me and for yourself* (Greek *anti emou kai sou.*) . *a hook*—only time this variety of fishing is mentioned in the Gospels.

QUESTIONS

349. Why was Peter asked about the tax? What does his "yes" answer indicate?
350. Did Peter catch the point Jesus made about sons and subjects?

(2) Matt. 18:1-6; Mk. 9:33-37; Lk. 9:46-48

Matt.

- v. 1 Jesus had spoken of John as being both great and small, Lk. 8:28. Doubtless the preceding events of the transfiguration (Peter, James and John only) and the dismal failure of the other nine to heal the boy added fuel to the fire about who was greatest.

NEW TESTAMENT HISTORY: THE CHRIST

- v. 2 They were in a house in Capernaum. The child may have belonged to one of the disciples.
- v. 3 *turn* (Greek *straphēte*, as in Jn. 1:38; Acts 3:19). The disciples definitely were going down the wrong road in this discussion. Service is the high-water mark of greatness, John 13:1-17.
- v. 4 *bumbles*—the way we “become” childlike; childishness is not humbleness.
- v. 5 Jesus means anyone who becomes childlike, be that someone child or adult.
- v. 6 *cause . . . to sin* (Greek *skandalizō*, see 17:27).
- v. 7 *better*—because the fate will be worse.

Mark

- v. 33 The discussion had arisen while returning from the region of Caesarea Philippi, but they had not told Jesus about it.
- v. 35 A great reversal from the normal flow of human life.
- v. 37 *receives me*—ie., receives My teaching, as is evident by the obedience.
- in my name*—under My authority, v. 38. See Acts 3:6; 19:13.
- receives . . . him who sent me*—God had just witnessed to Jesus in v. 7. See also Jn. 7:29; 8:42; 12:44-50; 20:21.

Luke

- v. 48 *least . . . greatest*—one of the hardest of things to be is least among all, especially for preachers who always think they must be seen and heard. Note Lk. 22:24-27.

QUESTIONS

351. Why did the disciples not want Jesus to know about

THIRD YEAR MINISTRY

- their discussion? Were they embarrassed when He asked them about it?
352. What attitude of mind and character of life were Jewish children taught in the days of the N.T.?
353. Do we have to become by choice what we once were by nature?
354. Do little children have to be taught humility? or are they such until taught differently?
355. Did the disciples understand "greatness?"

(3) Mk. 9:38-41; Lk. 9:49-50

Mark

- v. 38 The disciples thought such a prerogative was theirs alone.
- v. 39 Not an enemy, but a friend. This is the same principle Jesus argues in Matt. 12:22ff.
- v. 41 notice: "gives you." The servants of God were greater in number than the 12.

Luke

- v. 49 The party spirit has not left the world by any means. Perhaps smallness of nature or pride of party is responsible for the same attitudes as John expressed being expressed today.

QUESTIONS

356. Did John not care that people needed to be "demonized?"
357. Do you really care if people with whom you differ get to heaven as long as you do? or will God's heaven be big enough for you and others too? (If you have such an attitude, read Matt. 6:14-15, and ask yourself if you have any hope of heaven with such an attitude.)

(4) Matt. 18:7-35; Mk. 9:42-50

Matt.

- v. 7 See Luke 17:1-10.
- v. 8 Whatever the cost: sin costs more!
- v. 10 *their angels*: this may mean that every "little one" has a guardian angel, or that angels minister to people, though not necessarily in a 1 to 1 ratio. See Heb. 1:14.
- v. 12 Like Luke 15:3-7. The point is that God cares about each and everyone. Any effect, good or bad, we produce in another's life is quite important, both to us and to God.
- v. 14 Jesus died for all, and these "little ones" are among those. The same principle is seen in II Pet. 3:9.
- v. 15 *sins*—we better be positive it is a sin, not a slight.
tell (Greek *exelon*, rebuke to bring to conviction). *you have gained*—the total purpose of the effort is to gain the brother, not lose the brother. The whole chapter is intended to show how important it is to be concerned about our attitudes. We must want the good of others because they are God's, and we must share the attitude of God about the welfare of all.
- v. 17 The church was not actually in existence yet, but this instruction would within a year be very applicable. Jesus expected the "church" to become a reality, and remain so, Matt. 16:18.
- v. 19 *it will be done*—but the texts such as I John 5:14-15 must also be considered. God has determined what sin is, and laws concerning it, such as I Jn. 1:8-10.
- v. 20 Jesus cared for the saints, whoever they are, wherever they are.
- v. 21 Peter had listened to Jesus outline the three efforts to be made to gain a brother. Perhaps he won-

THIRD YEAR MINISTRY

dered if the limit to such action was three or more than three.

- v. 22 Forgiveness is not a quantity, but a quality to be exercised at every opportunity.
- v. 23 The reason for v. 22: to be godlike. We stand in relationship to God as the one who owed 10,000 talents. We stand in relationship to others as the man who owed 10,000 talents to one man, and was owed 100 by another (and we act about the same way sometimes!).
- v. 27 The man received better than he asked: not only was the debt cancelled, but the man was freed of all responsibility to it.
- v. 28 100 denarii was about two millionth's part of 10,000 talents someone has figured. It was at least a rather insignificant sum.
- v. 30 Cf. Matt. 6:14-15.
- v. 31 *greatly* (Greek sphodra, as in Matt. 2:10; 17:6; Mk. 16:4; Lk. 18:23; Acts 6:7; 27:18)

distressed (Greek lupeō, as in Matt. 14:9; Mk. 10:22; Jn. 16:20; Rom. 14:15; II Cor. 2:4; 6:10; Eph. 4:30; I Thess. 4:13).

reported (diasapheō, a detailed account). One can but think of the text in Num. 32:23; "Be sure your sins will find you out." See also Matt. 10:26.

- v. 33 The instruction for every disciple, and the example set by Jesus, Lk. 23:34.
- v. 35 The real reply to Peter's question in v. 21.

Mark

- v. 43 *bell*—the consequence of selfishness!
- v. 48 a description of the punishment for sinners who do not turn and become like children, Matt. 18:3.
- v. 50 A difficult verse, probably a proverb of the day. We understand Jesus to mean that we must preserve

our state by obeying His commands, or we will become worthless.

QUESTIONS

358. Does human nature make temptation to sin the normal thing in life (that is, since we are made moral beings, can we ever escape being faced with the choice of doing right or wrong, or of presenting such opportunity to others)?
359. Why did Jesus talk about cutting off a hand, or plucking out an eye? Was it in relationship to the seriousness of sin?
360. How much does God care about people?
361. Does a never-ending punishment in hell for sinners help to explain how terrible sin is?
362. If sin is so awful, what should be the course of action for someone who sins against you?
363. If someone asks you for forgiveness, do you think you should consider the answer Jesus gave to Peter's question?
364. What punishment, spoken of by Jesus in Matt. v. 35, and described in Mark vv. 44-50, will be the judgment of those who refuse to forgive others?
365. What part does the golden rule play in this little drama? Must one consider not only self, but the one who might also be involved?
366. What steps did Jesus give to follow when one person sins against another?

(5) Matt. 19:1-2; Mk. 10:1; Jn. 7:1-9

The Gospel writers, Matthew and Mark, now leave Galilee in their records of Jesus' ministry. Their accounts take us to Perea and on into Jerusalem. John's account, chs. 7-10, and Luke's account, chs. 9:51-18:34, give Jesus' ministry

THIRD YEAR MINISTRY

for some three months, in Perea and Judea, or from the Feast of Tabernacles to the Feast of Dedication. Matthew and Mark then pick up the story and give some events in His ministry for the three months preceding the Passover and Jesus' death.

John

- v. 1 *The Jews* (in John's Gospel, the Jewish hierarchy generally).
- v. 2 Every male was expected to attend this feast, Ex. 23:14-17; Deut. 16:16.
- v. 4 They reasoned by the world's standards, not God's. Thus did Satan tempt Jesus, and Peter so thought. Peter learned though, as can be seen in Acts 8:21-23.
- v. 6 Anytime was all right for them, as they had nothing to prove.
- v. 7 John 15:18-25.
- v. 8 Some Greek texts read "I am not going up to the feast yet." As indicated by the rest of John 7, Jesus did go up later; though not when the brothers suggested He go.

QUESTIONS

- 367. What feasts, and when, did every male Jew have to attend?
- 368. Do you suppose Jesus experienced in His own immediate family what He mentioned in Matt. 10:34-38; Lk. 12:51-53?

48. Samaria—Lk. 9:51-56

Luke

- v. 51 About six months remained. The intense hatred of the Jewish leaders kept Jesus pretty much on the move. Cf. Jn. 11:16.
- v. 52 So that they could procure lodging that He might slip in unnoticed.

- v. 58. Most Jews went across into Perea on the east side of the Jordan River rather than go through Samaria. However, Jesus wanted to avoid the crowds, so He went the little used road from Galilee to Judea through Samaria. The Samaritans and Jews generally hated each other, and only engaged in business, not social activities.
- v. 54 no love lost here!

QUESTIONS

369. Do you think James and John reacted as they did because they were snubbed by the Samaritans, because Jesus was, or just to show off if possible for the other disciples?
370. Does John act like the beloved apostle here? or is this a way love could be expressed?
371. Why did Jesus rebuke the men? Had He not told them to not preach to the Samaritans, Mt. 10?

49. Jerusalem (1)—Jn. 7:10-52

John

- v. 10 Luke's account, 9:51-56, is the record of the private trip to Jerusalem.
- v. 12 *muttering* (Greek *goggusmos*, as in Jn. 6:41; 7:32; Acts 6:1; I Cor. 10:10; Phil. 2:14).
leading . . . astray (Greek *planai*, "to lead off," "to wander," as a planet was thought to do in that era of time).
- v. 13 This is why the disciples are behind closed doors after the resurrection, 20:19, and why the parents of the blind man in Jn. 9 refused to tell the truth.
- v. 14 The feast was a week (8 days) long.
- v. 17 The comment in v. 14 was indicative that some would find a reason to reject the message because of

THIRD YEAR MINISTRY

what they thought about Jesus' background, etc., much as did the people of Nazareth, Matt. 13; Mk. 6.

- v. 18 The basic contrast between Jesus and any of the Jewish teachers.
- v. 19 They were not keeping it, either in spirit or truth. Jesus did both, and was not a just target of death, or hatred that leads to death.
- v. 21 He did it on a Sabbath.
- v. 22 But they did not marvel at all when it came time to keep the law and have a boy circumcised, even if the act was performed on a Sabbath.
- v. 24 The basic emphasis of Jesus' ministry was that truth was different than falseness, and the people should take care to know the difference.
- v. 25 A "yes" answer is expected.
- v. 26 They do not think the authorities know Jesus is the Messiah.
- v. 27 Popular theology of the time, but not true in fact.
- v. 28 They did not know God in the sense they should have known Him, or His Son.
- v. 29 Jesus claims to know God in such a way as to reveal God accurately. See 1:18; 14:8; Matt. 11:25-27.
- v. 31 They expect a "no" answer—Jesus had convinced many that He was the Messiah, as in v. 41.
- v. 34 A prediction of His ascension, as in 20:17.
- v. 36 Their hearts would need to be changed to go where Jesus was going.
- v. 37 The eighth day, with a special ceremony involving a priest carrying water into the temple. Jesus used the idea of water and applied it to Himself.
- v. 38 The Scripture Jesus mentions is unknown. Some suggest Isa. 58:11; Zech. 13:1 or 14:8.
- v. 39 This is the reason Jesus promised the Holy Spirit would be sent, as in Jn. 14:16, 26; etc.

- v. 40 *The prophet*—see 1:20; and probably the same idea in 7:52.
- v. 41 “No” is expected as an answer.
- v. 42 They are also aware of the connection between the Messiah and Micah 5:2.
- v. 46 The officers were probably temple officials, not Roman soldiers.
- v. 49 The general attitude toward the common people. This caused Jesus to see the masses of people as having no shepherds, and reflected in His compassion for them. They “heard Jesus gladly” Mk. 12:37; Lk. 19:48. For this reason, the Jews had decided not to put Jesus to death during the feast, Mk. 14:1-2, 10-11.
- v. 51 He expects a “no” answer, since Jewish jurisprudence did not judge a man without granting the right of defense.
- v. 52 A slam on the Galileans. They meant that no prophet such as they were expecting, and about which they questioned John, 1:19ff.

There is an interesting textual variation on this verse. Some of the best recent manuscript evidence lends credence to the textual reading: *the* prophet, rather than *a* (or *no*) prophet. It would fit better with the context to read it as: “the prophet (Messiah or forerunner) is not to rise from Galilee.” Some had been claiming this for Jesus, which is the reason for the attempted arrest.

QUESTIONS

372. What caused the Jewish people to be so unwilling to accept Jesus as the Messiah when He did so many signs, etc.?

THIRD YEAR MINISTRY

373. Does v. 20 indicate that some of the people may not have known about the plans to kill Jesus?
374. How had the people been judging by appearances?
375. Why could the men not arrest Jesus?
376. In what way had the Spirit not been given?
377. Does the remark of the officers in v. 46 indicate that Jesus so spoke that the crowds were too much in sympathy with Jesus to arrest Him at that time?
378. The council really did not want to give Jesus a fair trial—why not?

(2) Jn. 8:12-59

John

- v. 12 See 3:18-21
v. 13 See Deut. 19:15-21, where this principle is found.
v. 15 The standards are not the same for deity and humanity. But see v. 18.
v. 16 So in ch. 5:30ff.
v. 19 See Jesus' prayer in 17:3, 25-26. Of course, Jesus' claim is for deity since only deity could reveal deity adequately.
v. 21 Jesus apparently means that their refusal to accept Him, the life-giver, meant death for them. But see v. 24.
v. 24 The life Jesus brings is conditional.

I am he—the text reads as in v. 28 and v. 58: *egō eimi*. The pronoun "he" is not required by the Greek, though it is possible. The Greek is intended to be emphatic about Jesus' identity, but we have trouble expressing in English the same impression the Greek construction carries.

- v. 28 Jesus' death and subsequent resurrection would provide the necessary evidence. So many of the Jews and their leaders did believe, Acts 2, 4, 5, etc. Jesus mentions being lifted up in 3:14, here and in 12:32.

- v. 31 *If you continue*: the proof of disciples is faith and faithfulness.
- v. 32 *truth*—what Jesus had been trying to give them all of the time.
- v. 33 *They*—apparently a different group than those He addressed in v. 31. See v. 37 where this group plans to kill Him.
- v. 33 He will affirm their genealogy according to the flesh, v. 37, but also affirm they have the devil as their spiritual father, the important relationship of the two.
- v. 34 *every one who commits* (Greek *pas ho poiōn*, a life-time practice)
- v. 35 Only sons of God through Christ are not slaves to sin, Rom. 6:16-17.
- v. 36 The strong man is overcome, and his goods plundered, because Jesus is stronger. See I Jn. 4:4.
- v. 37 God's Word cleanses the mind and produces a character that is like Him. A man's life does exhibit what he is thinking, Mk. 7:1-23. The soil is too hard to receive and produce, Lk. 8:4ff., sometimes.
- v. 39 John's preaching had been directed at this very point, Matt. 3:9.
- v. 40 Abraham was not a murderer, as Cain, or Caiaphas, I Jn. 3:11; Jn. 11:49-53.
- v. 41 They understand Jesus to be talking about their fleshly origin.
- v. 42 That is, if they really apprehended God's message, they would reflect it in their lives. They had not accepted Jesus which, in essence, was the rejection of God's message.
- v. 43 The actual reason why they were still slaves, v. 34.
- v. 44 Even if they did not realize it, they could not be neutral. Unwillingness to be positive about Jesus placed them with the devil.

THIRD YEAR MINISTRY

- v. 45 He told the truth, even about the devil.
- v. 46 They could not find Him guilty, hence should have received Him as He presented Himself.
- v. 47 Their former choices of evil rather than good had caused their nature to be as it was at the time of Jesus' speaking.
- v. 48 The party is getting rough!
- v. 49 Would a demon-possessed man do what Jesus had done? They needed to heed 7:24.
- v. 51 Because God's Word is life-giving.
- v. 52 They had the same trouble in Capernaum, ch. 6.
- v. 53 They are beginning to get the message.
- v. 55 The severity of plainness!
- v. 56 So when Jesus came, and "Abraham's children" rejected Jesus, it was evident they were not really children of Abraham.
- v. 58 The claim for deity, as had always been the case, v. 25.
- v. 59 Because they considered His claims blasphemous.

QUESTIONS

- 379. Were the Jews unwilling to trust themselves to Jesus? Why could they not be of the same mind as the men in John 1:41ff?
- 380. How did Jesus mean the statement that the Jews did not know God, v. 19?
- 382. Is truth a body of facts, a person or both?
- 383. How many claims does Jesus make for Himself in this chapter? What kind of claims?
- 384. Do you think some of those discussing with Jesus could have been like those in Matt. 7:21-23?
- 385. Does one's set of mind actually determine what is heard?

386. What descriptions of character do the "parties" exchange?
 387. How does a person "know" God?

(3) John 9:1-41

John

- v. 2 The Jews (Cf. Job and his friends) thought sin caused physical ailments, etc. That they were right in some cases is clear. It was not true of all, though. The prophets mention both sides could be true, Jer. 31:29-30; Ezek. 18:2-4. See also Deut. 5:8-10; 24:16.
- v. 4 Jesus may mean death comes to all, or night in the normal sense of night. See 11:9.
- v. 9 He knew who he was and so testified. Others were not so willing. The final outcome of the day was that he was seeing both physically and spiritually.
- v. 14 Jesus had profaned the day as the Pharisees saw it.
- v. 16 Some were not quite so blind as others.
- v. 18 The testimony to Jesus was counter to the Pharisees' position, and the man was sticking to his story.
- v. 27 He is not only seeing but also thinking. No wonder Jesus sought him out, v. 35.
- v. 28 *revile* (Greek *eloidopēsan*, as in Acts 23:4; I Cor. 4:12; 5:11; 6:10; I Tim. 5:4; I Pet. 2:23; 3:9).
- v. 29 Such strong feeling for Moses (the law) prompted such statements and actions as in Acts 13:50; 15:21; 17:5; 21:20ff.
- v. 31 The current theological thought of the day, quite untrue in fact. However, the Jewish contempt for all other races probably helped promote such ideas.
- v. 32 Cf. 10:21, where they argue about this very thing.
- v. 36 *sir* (Greek *kurie*, which may mean either Lord or sir).
- v. 37 Where or how had the man seen Jesus?
- v. 39 Lord, as he meant it here, was a great step for a Jew.

THIRD YEAR MINISTRY

Such a belief was necessarily carefully considered before any Jew accepted it. Yet if they did not do so, they became blinder.

- v. 40 To know is to be responsible. The Jews had seen plenty of signs to know Who Jesus was.
- v. 41 Jesus means: if you did not know, you would not be responsible. You do know, and are responsible.

QUESTIONS

388. Did God allow or make the man to be born blind?
389. Why heal the man on the Sabbath? or did it make any difference? (Cf. Mk. 3:4)
390. Were the parents and the Jewish rulers like the other "children of Abraham" Jesus mentioned in 8:39ff.?
391. Is the man born blind equal to the Sanhedrin, or do they "out-argue" him?
392. Who really had eyes to see in this incident?
393. Who determines when a person "sees"—God or the person?

(4) John 10:1-21

John

- v. 1 Some consider that this section follows immediately after the conversation recorded in ch. 9. Others do not, but consider that it was spoken sometime later during the feast. It seems to follow in thought at least with the ideas of ch. 9. The unwillingness of the Jewish leaders to be shepherds, and the closing remarks to the man healed of his blindness could provide the setting for this section.
- v. 2 Jesus will present Himself as the shepherd and the door of the sheep. He is not a stranger because He knows His sheep, v. 5, nor is He a thief or hireling because He sacrifices Himself for the sheep, v. 11.

- v. 4 The familiar idea of the shepherd is often used by God's spokesman, as in Psalms 23, Ezek. 34, Jn. 21, I Pet. 5.
- v. 5 A shepherd is known by his character.
- v. 8 *all*: perhaps referring only to the religious rulers who had rejected Him. He may have had reference to the idea that all before Him who claimed to be the "door" of the sheep were not so.
- v. 9 Anyone may come, and all who do have both security and liberty.
- v. 10 *life*: a quality that Jesus gives to otherwise meaningless existence. Note Acts 20:29-30.
- thief* (Greek kleptēs, as in Matt. 6:19; 27:64; Mk. 10:19; Rom. 2:21; I Cor. 10:10; Eph. 4:28).
- v. 11 The shepherd lays down his life, even if the sheep are inappreciative and misunderstand.
- v. 12 *hireling* (Greek misthōtos, the one who works for wages as in Mk. 1:20).
- v. 13 The action of the men in ch. 9 is a good example.
- v. 14 A likeness of relationship between sheep and shepherd, and shepherd and Father. See Jn. 17:24-26.
- v. 16 *other sheep*—probably the lesson the disciples and early Jewish Christians had to learn. See Rom. 3:28-29. Jesus is the light of the world, not the Jewish nation.
- heed*: the hearer is the key to inclusion in the fold.
- v. 18 The close relationship of Jesus the man to Jesus the God is always a problem. Depending upon the point of view taken, Jesus raised Himself from the tomb, or God raised Him, as Acts 2:24. The word "God" could be understood as "deity" however. Hence the deity of Jesus made it impossible for the grave to hold Him.
- No one takes it*: Jesus was not the victim of cir-

THIRD YEAR MINISTRY

cumstances, but the sacrifice through love, not losing His life but giving it.

v. 19 *a division*: evident from Ch. 7:10ff.

QUESTIONS

394. In how many ways does Jesus present Himself in this section?
395. What are the characteristics of a good shepherd?
396. How does a person become a part of the fold of Christ?
397. If Jesus gave His life, is that not planned suicide?
398. Can you list things the Gospels record that demons did to people, or caused people to do?

(5) Luke 10:1-24

The harmony outline indicates that the 70 were sent out in or around the time of the Feast of Tabernacles, and from Jerusalem. However, Luke's account does not indicate exactly when this event took place, or where.

Luke

v. 1 The 70 may have preceded Jesus on His tour of the country. We interpret Lk. 9:51 to refer to the journey to Jerusalem for the Feast of Tabernacles. The text does not so state, however. Ch. 10:38 places Jesus in Bethany, just outside of Jerusalem, but 10:13-15 seems to imply a nearness of Galilee. Whether Luke means for his account to be other than a description of general events that occurred before the final week is uncertain.

two by two—a good general principle for personal work. We should not treat it as a divine imperative, however.

v. 2 See Matt. 9:35ff.; Jn. 4:35 ff.

pray: get involved with God in the work!

- v. 3 Cf. the somewhat parallel text in Matt. 10:1ff.
- v. 4 Jesus taught them that they were 1) to go, 2) and to trust God for their needs 3) to preach and not worry about results, and 4) to let circumstances determine their stay in any place. The same general ideas are yet true for every laborer in the kingdom.
- v. 11 *The kingdom near*—if only in preaching about it.
- v. 12 Sin has punishment, both here and hereafter.
- v. 13 Ref. Matt. 11:20ff.
- sackcloth and ashes*: signs used to indicate a sorrowful condition or state of mourning exists.
- v. 16 The same principle so often stated: the messenger must consider himself and his message as being inseparable from his Master.
- v. 17 The length of the tour is not stated, nor the place to which they returned.
- v. 19 *serpents and scorpions*: whether literal or figurative is not said. God did bear witness to their message; Heb. 2:4, but what these particular acts would prove is unknown, since the frequency of such occurrences would be rare. However, see Ex. 4:1ff.; Num. 21:6; Deut. 8:15; Rev. 9:3, 10.
- v. 20 *spirits*: the nature of beings in the metaphysical realm. We are also spirits as they, but inhabit a physical body while here in this world, not the metaphysical world.
- v. 21 See Matt. 11:25ff.
- v. 23 They were the original recipients out of the great mass of people upon whom the ends of the ages have come, Rom. 16:25-26; Col. 1:26; Heb. 11:40; I Pet. 1:10-12.

QUESTIONS

399. How do the instructions in Matt. 10 compare with these in Lk. 10?

THIRD YEAR MINISTRY

400. What general principles were true then that are still usable today?
401. What was so damning about the message preached? its character (nature)? or what?
402. What was so great about casting out demons? Was it greater than preaching the good news of the kingdom, or did it just seem so?
403. Did Jesus point out what was truly great?

(6) Luke 10:25-37

Luke

- v. 25 Luke does not locate this incident as to time or place. *test* (Greek *ekpeirazōn*, 'to test' or 'to tempt' throughout the N.T.).
- do*—obedience of faith is a timeless Bible concept.
- eternal life*—the quality Jesus gives to existence.
- v. 26 God had revealed a way for him, and Jesus wondered if he knew it. The young ruler in Matt. 19:16ff., and the scribe in Mk. 12:28ff. are very similar incidents. The verses quoted are Deut. 6:3; Lev. 19:18. All other laws given were simply applications of this basic principle; obligation (love and obedience) to God and man is inseparable. That is why James 2:8ff. reads as it does. See also Matt. 7:12.
- v. 28 Faith was the principle of "doing" those commandments, since no person could (or can) prove that life will come as promised. God must be believed for this.
- v. 29 The common human tendency: justify self. See Rom. 2:17-24; then 3:9-20.
- v. 30 *half dead*: opportunity still there to aid!
- v. 31 *priest . . . passed by*: a law-keeper superficially, not a lover as the law expected.

- v. 34 The Samaritan was a "doer," as Matt. 7:12 shows one must be.
- v. 35 He really went the second mile.
- v. 37 The man answered his own question. The man who helped was not a stranger, but a neighbor to the one hurt. See Heb. 10:32-24; 13:1-3.

QUESTIONS

- 404. Did the lawyer test Jesus or get tested?
- 405. Why, when the man answered Jesus, did he not quote the 10 commandments? Are they simply applications of the 2 commandments he did quote?
- 406. Can you absolutely prove that you can inherit eternal life by obeying the Scriptures, or do you have to take God at His word?
- 407. How could the Samaritan be the "neighbor" the man asked about—he was the one helping, not being helped, was he not?

50. Bethany—Luke 10:38-42

- v. 38 The first appearance of these people in Luke's Gospel. It seems from Jn. 11:3 that Jesus was there often.
- v. 39 Martha seems to have been the oldest of the two sisters, the mistress of the house, thus primarily responsible for the guests. Mary appears in Jn. 12 in much the same role as here!
- v. 40 *distracted*. (Greek periespatō, from peri and spaō. The verb occurs in Mk. 14:47 and Acts 16:27 with the idea of drawing (a sword). Thus the preposition and the verb convey the idea of drawing about or around. It is used in literature of the day for being overly burdened, worried, greatly concerned over little, etc.).

THIRD YEAR MINISTRY

serve (Greek diakonian, minister, etc., elsewhere).

help (Greek sunantilabētai, 'to take ahold').

- v. 41 *anxious* (Greek merimnais) what Jesus warned against in Matt. 6:25. See Phil. 4:6.

troubled (Greek thrubazō, as in Matt. 26:5; 27:34; Mk. 5:38; Acts 20:1; 24:18, a tumult or disorder).

- v. 42 *not taken away*—at the moment, Martha had the cares and problems of the world, and Mary was unencumbered good soil. Martha was not condemned for preparation, but for her attitude about it. Hearing Jesus was (and is) a question both of time and eternity.

QUESTIONS

408. Did Jesus ever express concern for people who were hungry etc., as Martha was doing?
409. How does a person honor Christ in day-to-day living?

51. Place of Prayer—Luke 11:13

Luke

- v. 1 Matthew's account, ch. 6:5-15, places the prayer in a context about discipleship. This text has the disciples wanting to be taught to pray.

- v. 2 *when* (Greek hotan, anytime)

say: the form is neither wrong nor right for us to use, but the general thought progression is good to follow.

- v. 3 *daily* (Greek epiousion for which the exact meaning or derivation is still unknown. It has not been found in any literature except here and in Matt. 6. From the general context, it seems to imply the bread that is needed, thus the "daily" bread.)

NEW TESTAMENT HISTORY: THE CHRIST

- v. 4 Our attitude toward others must not be a stumbling block to them.
- lead us:* the prayer is that God will answer this whole prayer through us in such a way that His will and His way are true every moment in each disciples' life.
- v. 5 God is a friend: don't be ashamed to state our need.
- v. 8 *importunity:* our need, seen and answered by our Father.
- v. 16 God will not give useless or dangerous things to His children, but good things.
- v. 13 The prayer is: more of God and less of us.

QUESTIONS

410. How much difference in this prayer and the one in Matt. 6 (thoughts expressed, form used, words used, etc.)?
411. What caused the disciples to ask Jesus about teaching them to pray?
412. What is the point of the illustration in vv. 5-8? Is it similar to 18:1ff?
413. What did Jesus mean by His expression "if you . . . being evil?"
414. What relationship to the request of the disciples did the thought about the gift of the Holy Spirit have? Did Jesus mean that prayer should be made with the "best" gifts in mind, such as the Holy Spirit, or prayer should be made only to get the Holy Spirit, or what?

52. Place Unknown—Luke 11:14-28

Luke

- v. 14 See the following scriptures on demon possession: Matt. 4:24; 8:15-16, 28-34; 9:32-34; 12:22ff.,

THIRD YEAR MINISTRY

13:22; 17:14ff.; Mk. 1:21-28, 32-34; 3:11, 22-27; 5:1-20; Lk. 4:31-37, 41; 8:26-39; 9:37-43; 13:10-17.

- v. 15 They could not deny the miracle, so malign the source, as in Acts 4:16ff.
- v. 16 Much like Satan in ch. 4:9. The men came to test Jesus, accusing Christ of working for Beelzebub. In reality, they gave evidence of Satan.
- v. 19 The "sons" of the men were not accused of working for Satan in their efforts in this regard, hence the power of prejudice was overruling the men's common sense.
- v. 23 Since the issue was such that men could not be neutral about Jesus, the stance taken by the men placed them in opposition to Jesus. Such a state in life was unpardonable, and would remain so until they changed.
- v. 24 The reality of the spirit world is clear.
- v. 25 *put in order*—garnished in K. J. (Greek kosmeō, as in Matt. 12:44; 23:29; Lk. 21:5; I Tim. 2:9; Titus 2:10; I Pet. 3:5; "to arrange" or "bring into order." Our English cosmos).
- v. 27 Note Luke's inclusion of women as they played a part in the Gospel narratives.
- v. 28 The only real state of blessedness is to be a child of God, though nothing inherently wrong with motherhood.

who hear (Greek hoi akouontes, habitual hearers)

(who) *keep* (Greek phulassontes, guard or keep watch habitually).

QUESTIONS

415. Did jealousy play a part in the statements of others

about Jesus? Does jealousy blind us to the good in other people?

416. What did Jesus mean in v. 20 about the "finger of God?"
417. Had Jesus given an illustration in real life of overcoming a "strong man?"
418. Why was the demon and seven other spirits able to re-enter the "house" from which the demon was evicted?
419. How would a person keep free from demon possession? Would hearing and guarding God's Word do it?

Luke 11:29-36

Luke

- v. 29 *crowds*—if the crowds were anywhere close to the size of the crowds in ch. 8 (5,000), the third year of ministry was really a popular year for Jesus as far as the common people were concerned. The size of the crowds doubtless made the religious leaders more anxious to do away with Jesus.
- v. 30 Jonah was a sign and his message was considered by men of Nineveh to be from God. Jesus was a parallel to Jonah.
- v. 33 Ref. Matt. 6:22-23
- v. 34 What the lamp (light) is to the room the eye is to the mind, and the soul.

QUESTIONS

420. Did the crowds give some indication that they wanted to see a sign, which prompted Jesus to say what He did in v. 29?
421. How does darkness overcome light (i.e., how can light be darkness)?

53 Pharisee's Home—Luke 11:37-54

Luke

- v. 38 *wash* (Greek ebaptisthē)—a real burden! No wonder Jesus condemned them so severely. Too many of the people tried to put Jesus into old wineskins.
- v. 39 We must make the whole man "clean."
extortion (Greek harpages, "thievery", etc.)
wickedness (Greek ponērias, "wickedness," "maliciousness," as in Matt. 22:18; Mk. 7:22; Rom. 1:29; I Cor. 5:8; Eph. 6:12).
- v. 41 Right motives make the difference in whatever one does.
- v. 42 *woe*—an exclamation depicting sorrow or distress about another's condition, etc. Jesus indicates their character was in a bad state of affairs.
justice (Greek krisin, as in Matt. 5:40; 7:1; 10:15; 23:33; Lk. 7:43; 19:22; Jn. 3:17; 5:24, 29, 30; 7:24; 8:15; 12:31; 18:31; Acts 4:19; 13:27; 46; 16:15; 17:31; 23:3; 25:9; Rom. 2:16, 27; 14:3, 10, 13, 22; I Cor. 2:2; 4:5; 10:29; 11:31; II Cor. 5:14; II Tim. 4:1; Heb. 10:27, 30; Jas. 5:12; Rev. 18:8, 10; 19:2).
- v. 44 *graves*—defilement, the issue with which the Pharisees were concerned, v. 38.
- v. 45 *reproach* (Greek hubrizō, as in Matt. 22:6; Lk. 18:32; Acts 14:5; 27:10, 21; Rom. 1:30; II Cor. 12:10; I Thess. 2:2; I Tim. 1:13.)
- v. 46 *lawyers*—scribes
burdens—as the demand that people wash hands, etc., before the meals, or be considered sinful. See Matt. 11:28-30.
- v. 47 A good deed outwardly, but really made them into hypocrites because they did not obey the prophets any better than their "fathers."

- v. 48 See Acts 7:51ff.
 v. 49 *Wisdom of God*—perhaps Jesus refers to a “planning session” in heaven.

this generation—and it happened, for Jesus came (Jn. 15:24) and the Roman army came (Lk. 21:20).

- v. 53 *press him hard* (Greek *deinōs enechlein*. See *deinōs* in Matt. 8:6, ‘fearfully’ or ‘terribly’! See *enechō* in Mk. 6:19; Gal. 5:1; II Thess. 1:4. It means ‘to hold in’ or ‘to hold against’; as a grudge, or in anger, etc.).

to provoke (Greek *apostomatizein*, only here in N.T. It means to observe or watch closely, to “push” or put pressure on).

QUESTIONS

422. What was the point about cleansing the cup on the inside rather than the outside?
 423. Were the Pharisees expected to tithe by God’s law?
 424. How could a person walk over a grave and not know it?
 425. What did contact with a dead person or object cause to the one contacting such? (Num. 19:11-22).
 426. In what way(s) did the Pharisees and scribes bind burdens on people?
 427. How did the scribes take away the key of knowledge? Did the ideas the disciples held about the Messiah and the nature of the kingdom reflect the teaching of the scribes?
 428. Was the attitude of the scribes and Pharisees mentioned in v. 53-54 the same basic attitude their “fathers” held who killed and persecuted the messengers of God?

54. Before a Multitude (1)-(6)—Luke 12:1-59

Luke

- v. 1 This third year is often said to be the year of opposition, but if so, the common people were not the ones opposing Christ. As this text indicates, multitudes followed Christ.
- v. 2 *leaven*: their teaching.
- v. 3 See Matt. 10:26. In this context, a man's decision for Christ would sooner or later be known, regardless of efforts to hide it.
- v. 5 *fear him*: God. He is the judge of all, and His eyes are upon all, Heb. 4:13.
- v. 6 God is the God of little things and big things, too, though humanity may think He is too busy or too far away to care about either.
- v. 8 *acknowledge* (Greek *homologeō*, elsewhere "confess," etc.).
- v. 10 *against* (Greek *eis*, normally translated unto or into. The construction is paralleled by the second part of the verse concerning the Holy Spirit. The problem: the Greek construction only has "blaspheme" one time—is it to be understood twice? The text would then read: "whoever speaks against (blasphemes) the Son . . . speaks against (blasphemes) the Holy Spirit"). The difference between the Son of man and the Holy Spirit may be this: it was under the direction of the Holy Spirit that the message about the Son of man was to be preached. If the message was refused, no forgiveness was possible. See v. 12.
- v. 11 Trust the issue with God!
- v. 13 See Deut. 21:17. The presumption seemed to be that the brother was illegally retaining the inheritance.

NEW TESTAMENT HISTORY: THE CHRIST

- v. 14 The man asked the wrong person to get what he wanted.
- v. 15 Life is not out of the things being possessed, as vv. 16-21 show.
- v. 16 God was caring for him (Matt. 5:44-45) but he was not thankful, Rom. 1:21.
- v. 17 *thought*: he reckoned up or figured out his wealth (Greek *diologizetō*, as in 1:29; Matt. 21:25).
- v. 20 God's idea of ownership was not like the man's idea at all.
- v. 21 Cf. Lk. 6:24; 16:8-9.
- v. 22 See Matt. 6:25ff.
- v. 30 *all the nations*: ie., those who know not God, and do not know of His willingness to care and share.
- v. 32 We have but to seek it and the kingdom is ours.
- v. 33 The attitude that God wants is opposite that of the rich fool, regardless of how much material wealth we receive from God. We do not consider ourselves as owners, but stewards of possessions we have. True life is not found in the material, but the spiritual. Remember we are spirit beings, living in a material body. God, Who is life, is a spirit being also.
- v. 35 The stewardship of life demands our attention be forever on our day-to-day responsibility to our Master, Who may appear at any moment for a reckoning.
- v. 40 The fact of His coming, and the suddenness of His appearance are sure: the rest is not told at all. We must live in constant readiness, lamps all trimmed and bright.
- v. 41 Peter was not sure for whom the sermon was intended, so Jesus told an illustration in which Peter could find himself.
- v. 45 The servant thought that the postponement was can-

THIRD YEAR MINISTRY

- cellation: he was wrong. Some one well suggests that the most dangerous word is "tomorrow."
- v. 46 We must follow as God beats the time for us, not as we desire things to be.
- v. 48 The state in which one is found (Jn. 3:36) determines destiny forever. We are responsible for any and all things entrusted to our care.
- v. 49 A difficult verse—perhaps Jesus has in mind the some general principle as in Matt. 10:34ff., and our text, vv. 51-53.
- v. 51 Decisions must be made while we are in this life—the next life is too late.
- v. 54 You can decide for the right things with the same mental faculties as you use to judge the weather situation, the one decision does not require any more ability than the other, and the information is yours for the "seeing."
- v. 56 They were excusing themselves on the basis of lack of information (In Lk. 11:29, they were seeking a sign, as in Jn. 6:30, etc.) when the case really was that they had all the information they needed.
- v. 57 See Jn. 7:17, 24. The facts are clear, the ability to decide is yours, the necessity to decide is based upon the reality of eternal heaven or hell, plus the fact that the Master may come at such an hour as you think not. See Lk. 17:26ff.

QUESTIONS

429. Was it "standing room only" where Jesus was?
430. What did the "leaven" of the Pharisees produce (i.e., why should they beware of it)?
431. Will justice eventually be meted out by God?
432. Does God know enough to correctly judge everyone?

NEW TESTAMENT HISTORY: THE CHRIST

433. Can a person be rich toward God and be rich materially?
434. In what way are birds and grass examples for us?
435. Did Jesus forbid effort to feed and clothe self, or undue worry about life's necessities like food and clothing?
436. What does treasure in heaven consist of?
437. How does one get treasure in heaven?
438. The faithful and wise steward: what "possesses" him (ie., what characterizes his daily life)?
439. Why would a servant who did not know still receive a beating?
440. How would households be divided: emotionally, physically, religiously, or how?
441. Has God equipped humanity with the ability to discern "signs" and decide for Him? (Cf. Rom. 1:18ff).

(7)-(8)—Luke 13:1-9

Luke

- v. 1 No record of this in the N.T., but Pilate was not above such activity.
- v. 3 *likewise* (Greek *homoios*, as in Matt. 22:26; 27:41; Lk. 3:11; 5:10; Jn. 5:19; 6:11; 21:13; Rom. 1:27; I Cor. 7:3ff.; I Pet. 3:1, 7) or in the same way. He means that unless they change their way of thinking, as the Galilean's life ended, their lives will certainly come to an end.
- v. 4 No record of this in the N.T. The point of the two illustrations is this: life is uncertain, the end is sure. Unless you prepare, your life will end in disaster just as the Galilean's lives did, etc.
- v. 5 *likewise* (Greek *hōsautōs*, as in Matt. 20:5; 21:30; Rom. 8:26; I Tim. 2:9; 3:8).
- v. 9 God is longsuffering, and kind, but the unwilling-

THIRD YEAR MINISTRY

ness to decide will bring disaster, because the end of life will come, if not unexpectedly, yet surely.

QUESTIONS

- 442. Do you think your life could end while you were attempting to worship God?
- 443. Can the final opportunity ever come?
- 444. Does God sometimes apparently give "second chances?"

55. In a Synagogue—Luke 13:1-17, 18-21

Luke

- v. 10 Many were opposed to Jesus, but others earnestly desired to hear Him, as 12:1 shows.
- v. 12 *You are freed* (Greek *apolelusai*: you are freed, to stay that way)! Jesus demanded no faith on her part, just an opportunity to help her.
- v. 15 They did not share what they professed: the love of God.
- v. 17 See John 5 for a list of miracles performed on Sabbath days.

QUESTIONS

- 445. How did the "spirit of infirmity" manifest itself in the women?
- 446. What makes a man worth more than an animal? Do all men believe that humans are essentially different than animals, or have some considered that dogs, rats and humans are only different in degree, not kind?
- 447. What would make a person unable to rejoice in the blessing another received from God?

56. Temple in Jerusalem—John 10:22-39

John

- v. 22 *Feast of Dedication*: late December. See the Inter-testament period for the origin of this feast.
- v. 24 He had claimed it many times, as in John 3, 5, 8, etc.
- v. 25 His miracles had also confirmed His testimony. Their problem was a misconception of the Messiah's nature. When He claimed to be one with God, as in v. 30, they wanted to stone Him for blasphemy, failing to understand that the Messiah was deity in the flesh.
- v. 27 Jesus' sheep have two characteristics: habitual hearing and following.
- v. 28 Eternal life from Christ precludes the state of perishing, which is loss of well-being, not annihilation. *snatch*—He had promised protection as the good shepherd v. 9-10, etc.
- v. 30 The same power is inherent in both Father and Son. *one* (Greek *hen*). The construction and word are found in 17:11, 22, the same word in 17:23; I Jn. 5:8).
- v. 31 tense moment!
- v. 32 He knew what their problem was, and this question got it out in the clear. See v. 25.
- v. 33 Contrary to many modern-day commentators, Jesus did claim deity, and when His auditors so understand, He did not deny but rather affirmed their conclusion.
- v. 34 Psalms 82:6.
- v. 36 If the judges through whom God spoke could be called "gods," how much more could Jesus.
- v. 38 The signs He continually did were evidence that God was in their land in person of Jesus.

THIRD YEAR MINISTRY

QUESTIONS

448. What do you know about the Feast of Dedication?
449. Why was Jesus walking in the temple porch—because of bad weather?
450. Describe the "sheep" who belong to Christ as He described them.
451. How secure is the person in Christ?
452. The Jews tried to stone Jesus: why? Were they drawing false conclusions from what He said?
453. Why do you think Jesus called the men in Psalms 82:6 to their attention?

57. Perea—Jn. 10:40-42

John

- v. 40 This is probably on the eastern side of the Jordan River, perhaps near Bethany where He was immersed by John.
v. 41 Those without vested interests were glad to listen, and often with minds willing to hear.
Cf. Deut. 18:20-22 in connection with the compliment given John by the people.

QUESTIONS

454. Did Jesus go to the Perea/Decapolis area to avoid the arrest attempts?
455. What did the disciples think about Jesus being in Jerusalem (Cf. Jn. 11:16)?

58. Cities and Villages in Perea—Luke 13:22-35

Luke

- v. 22 Our outline has basically followed Luke, though interspersing his account with other events that seemingly corresponded. However, Luke has not indicated that Jesus was around Jerusalem since ch.

10:38-42. All his account shows is that Jesus apparently kept out and away from Jerusalem until the triumphal entry in ch. 19.

- v. 23 The Greek text indicates that the question was: "is the number of people being saved small?"
- v. 24 *Strive* (Greek agonizesthe, or "really strive")—it would take all a man's life to give so that eternal life could be gained: no small agonizing, that!
- narrow*—like Matt. 7:13. Because the gate is so restricted, the warning about the struggle to enter was very pertinent. Notice the Greek word translated as "strive" in Jn. 18:36; I Cor. 9:25; Phil. 1:30; Col. 2:1; 4:12; I Thess. 2:2; I Tim. 4:10; Hb. 12:1.
- v. 25 A problem of punctuation exists at this juncture. R.S.V. punctuates with a period at the end of v. 24, and begins a new sentence in v. 25. It is possible to put a comma after the end of v. 24, and the period at the end of "doors" in v. 25a.
- v. 26 Jesus explained that the door was open, but when the Master of the house came, the door was shut and no one enters. Hence, the time to enter was while the door was open.
- v. 27 Ref. Matt. 7:21-23. Perhaps the same sort of responsibility was upon the people "outside" as upon the servant in Lk. 12:42-48, and they failed to keep faithful.
- v. 28 The context emphasizes the same point as in Jn. 10:26-30: The sheep who stays secure in the Father's hands is the one who keeps hearing and following. "Once in grace, always in grace" is a doctrine that can be true for every disciple, but is not necessarily true for any—unless the disciple so wills it. The books *Life in the Son* and *Elect in the Son* by Robert Shank are not listed in the Bibliography at the end of the book, but these two books are ex-

THIRD YEAR MINISTRY

cellent for study of the doctrine mentioned above. Shank well points out that the argument is not about the believer's security, but about who the believer is.

- v. 29 *sit*: the oriental custom was recline, and the Greek word means recline, not sit as western cultures do.
- v. 30 The criterion of judgment was different than His hearers thought. They needed to reevaluate what God wanted.
- v. 31 Jesus was apparently in the domain of Herod Antipas.
- v. 32 A difficult saying which we take to mean that Jesus knows how and when death is to come to Him, and Herod is not then a worry.
- v. 33 Cf. ch. 11:47ff. See also Matt. 23:37ff.
- v. 34 Jesus describes Jerusalem as anything but a "city of peace," which is the meaning of the name.
- v. 35 The message to the Jewish nation is this: God no longer cares for you as a nation. His grace is henceforth to be all who are willing to accept God's messenger(s).

QUESTIONS

- 456. Is the question about "Who is a Christian/saved" still being asked today? Why?
- 457. What answer does Jesus give to the question? What kind of person must one be to have salvation?
- 458. Did Jesus give any examples as to what kind of people were being saved (ie., or had entered in the narrow door)?
- 459. From what areas or sections of the earth will people be saved? What do you think Jesus implied by vv. 29-30 about who can be saved?

59. Pharisee's Home—Luke 14:1-24

Luke

- v. 1 See under John 5 for a list of miracles done on the Sabbath.
- v. 3 He had discussed this issue in a synagogue in Capernaum, ch. 6:6-11. He pointed out that it was quite lawful "to do" and even "to do good," and more specifically to do good in saving life rather than killing or destroying life.
- v. 6 We need to ask God daily for the ability to get first things first.
- v. 7 *He told a parable:* they were trapped before they knew it.
- v. 11 See ch. 18:14; Matt: 23:12.
- v. 12 *the man who had invited:* Jesus had something for everyone. Selfishness too often plays a part in our "choosing."
- v. 14 God will reward, in His own good time.
- v. 15 The mention of the future reward from God brought to mind the happy state of all who would be counted as faithful.
- v. 16 Jesus replied, in effect, that the statement was true. However, it was also true that those who were honored thusly might be characterized by different traits than some thought. See under Matt. 19:30ff.
- v. 20 God, in the person of the Master, may have been gracious, but He was also just.
- v. 24 The cost of the excuse is seen in the light of the blessings missed. See Matt. 22:1ff.

QUESTIONS

460. Define dropsy.
461. Why did Jesus ask about healing the man: was it because the day was the Sabbath?
462. Why could no one reply to Jesus' questions?

THIRD YEAR MINISTRY

463. Can a person be ostentatious (showy) in his humbleness?
464. Did Jesus forbid inviting into your home anyone who could return the favor? or was He simply rebuking the self-seeking spirit in us?
465. How would you describe the character of the people who went to the banquet?

60. Before Great Multitudes—Luke 14:25-35

Luke

- v. 25 The multitudes doubtless included many who needed the challenge Jesus gave, just as the crowds did at Capernaum in John 6.
- v. 26 The word "hate" must be understood in relationship to many other texts, such as Matt. 10:37; 22:39; Eph. 5:25; Titus 2:4; I John 4:-1; etc. God is first, others next in line.
- v. 30 The person was not a good example of a disciple. The disciple should consider as much as possible the cost of being a disciple before deciding to follow Jesus. Stated differently, once commitment to Christ is made, that commitment is to be to the finish, regardless of the cost.
- v. 33 The cost of commitment is all one has. The Greek word translated "renounce" is *apotassō*, found in Mk. 6:46; Lk. 9:61; II Cor. 2:13.
- v. 35 Jesus says: Better listen in! He warns in Lk. 8:18 that we must take heed of "how" we hear.

QUESTIONS

466. How can one hate his own life? Do we do it by starving ourselves, or denying self pleasures, etc.?
467. What is the basic point of the two illustrations?
468. How useful in that day would "saltless salt" have been? How useful is an uncommitted disciple?

61. Place Unknown (1)—Luke 15:1-32

This sermon by Jesus involves both chs. 15 and 16 of Luke, but we will break it up into chapters for better ease in discussion and question.

Luke

- v. 3 A parable generally illustrates one basic point. Doctrine is not established by a parable, though the parable can illustrate the doctrine. Each of the parables in this chapter centers around something lost and its importance in relationship to the person (or thing) to which that lost thing belongs.
- v. 7 The point: God's concern for that which lost.
- v. 8 Another analogy to illustrate the same point as in v. 7.
- v. 9 The coin was a Greek silver drachma. See Lk. 21:1-4.
- friends* (Greek *philas*. See Jn. 21).
- v. 10 Note Lk. 12:57-59; 13:1-5.
- v. 11 This parable (if it be a parable) has two major points of emphasis: the father and his relationship to the sons, the sons and their relationship to each other and their father.
- v. 12 The younger son would probably get one-third of the property.
- v. 13 *squandered* (Greek *diaskorpizō*, as in Mk. 14:27; Jn. 11:52; Acts 5:37).
- v. 16 An ancient proverb: a fool and his money are soon parted. Paul's advice in I Tim. 6:9-10 and Jesus' comments in Lk. 16:9 are pertinent.
- v. 17 The launching pad for repentance: to see self as one really is.
- v. 18 This change of mind, after reflection on the (part) state of one's life, was repentance. The fruit of his repentance was the trip home.

THIRD YEAR MINISTRY

- v. 19 Sin does make life useless, lost and undone, Isa. 6:5. God's Word alone can both tell us what we are and what we can become, without distorting the facts at all.
- v. 20 God, like the father, allows the "son" to make his own choices, but does not cease caring.
- v. 21 The son at least knew that his life had two separate yet related aspects: responsibility to God and parent. Neither relationship can be dishonored and the other relationship kept rightly.
- v. 23 The mention of the robe, etc., is incidental. The point was the father's care for the son.
- v. 24 dead and lost: synonyms in this verse.
- v. 25 The elder son represented the murmerers in v. 2.
- v. 28 See ch. 11:52; Matt. 21:32.
- v. 29 *never disobeyed*—true. But he never shared his father's love or concern either. The elder son was but a son in name only, not in nature.
- v. 30 Notice: "this your son," not "my brother."
- v. 31 Hell will surely be filled with people who finally see how much of life they really missed.

QUESTIONS

469. Name the basic point the parables in this chapter illustrate.
470. How will angels know anyone repents? Would this indicate that they know what happens on earth?
471. The two sons were typical of what classes of people in Jesus' day?
472. What brings repentance into one's life? What is repentance? What does it result in?

(2)-(3)—Luke 16:1-31

Luke

- v. 1 *steward* (Greek *oikonomon*, as in Lk. 12:42; 16:1-8;

NEW TESTAMENT HISTORY: THE CHRIST

Rom. 16:23; I Cor. 4:2; 9:17; Gal. 4:2; Eph. 1:10; 3:2, 9; Col. 1:25; I Tim. 1:4; Titus 1:7; I Pet. 4:10).

wasting—as in 15:13.

v. 2 *account* (Greek *logos*, see Jn. 1:2).

v. 4 The sudden flash of inspiration: prepare while I can.

v. 6 *your bill* (Greek *ta grammata*, ie., your bills or accounts. See this word in Jn. 5:47; 7:15; Acts 26:24; 28:21; Rom. 2:27, 29; 7:6; II Cor. 3:6, 7; Gal. 6:11; II Tim. 3:15).

quickly: speed is of the essence.

v. 7 So he reduced the two accounts considerably, one by a half, the other by 20 per cent.

v. 8 The man was commended for one thing only: foresight. Jesus described him as dishonest, but wise in use of present opportunities.

v. 9 unrighteous in contrast to true, v. 11. It will surely fail, but wise use has provided something else when it does. This principle may be a key to the commendation of Jesus in Matt. 25:35-40.

v. 10 As a general principle, a person's life exhibits that person's thought processes.

v. 12 The "unrighteous mammon" really belongs to God. Cf. 12:15-21.

v. 13 The same general idea in Matt. 6:24; 12:30; Lk. 11:23.

v. 14 *scoffed* (Greek *ekmuktērizō*, 'to hold up the nose derisively'. See ch. 23:35). They were possessed by love of money.

v. 15 *Those who justify* (Greek *hoi dikaiountes*, habitually self-acquitters). They really needed a physician.

v. 16 *violently*: does this mean 1) efforts by many to get in, or 2) attempts by many to use it?

THIRD YEAR MINISTRY

- v. 17 The law said that all were to worship God first, not self nor things. These men were in violation of that first and great commandment.
- v. 18 As an example of v. 17, the law expected no divorce. Instead, the Jewish nation in general practiced it.
- v. 19 *A rich man*: like the money-lovers of v. 15.
- v. 20 The Pharisees would have walked by on the other side.
- v. 22 The least imaginable thing: such a person going to heaven. In the Pharisee's sight, he would doubtless have been a sinner.
- v. 23 The picture, like that in the Beatitudes, is completely reversed as the Jews would have described it.
Hades: probably refers to the state of the dead, regardless of where they might be. However, its derivation is disputed as well as its meaning (usage). It occurs in Matt. 11:23; 16:18; Lk. 10:15; Acts 2:27, 31; I Cor. 15:55; Rev. 1:18; 6:8; 20:13, 14. It is translated as "hell" in King James, which is a poor translation. The word "hell" should be used to translate the Greek *Geenna*, found in Mt. 5:22, 29, 30; 10:28; 18:19; 23:15, 33; Mk. 9:43, 47; Lk. 12:5; James 3:16.
- torment*: if not literal, was it really worse?
- v. 24 *After the door is shut*, (Lk. 13:23ff.) He wants "in the house."
- v. 25 *Son*: by flesh, not faith.
- remember*: in possession of attributes of personality, such as feeling, thinking, etc.
- v. 26 Our failure to understand some of the facts presented here does not negate their reality. We may not understand their ability to "see" and "talk," etc., but that does not make it untrue.
- v. 28 The fact of choice: he had made the wrong one,

- justifying himself, but was judged a poor steward. Death did not change his character, nor does it for anyone else.
- v. 29 *Moses and the prophets*: God's revealed way of salvation for his day and time—and he had neglected the second of the two greatest commandments: love your neighbor as yourself.
- v. 30 A resurrection is not convincing necessarily, as Abraham quickly points out.

QUESTIONS

473. The parable of the unrighteous steward was told to illustrate what points? (What sort of contrast between "righteous" in v. 15 and "unrighteous" in v. 8 is there?)
474. What did the Pharisees love and serve, thus making it their god?
475. Where does the text say that vv. 16-31 is a parable?
476. How many "ways" are presented in the whole text from 15:1-16:31? Did Jesus ever warn about wrong "gates" and consequent rewards? (Cf. Matt. 7:13 ff.)
477. How did the man know Abraham? How did he know his brothers were still alive?
478. How did Abraham know about him and Lazarus?
479. If we reject this story because we can not understand how it could be true, what has become our god?

Luke 17:1-10

Luke

- v. 1 *Temptations*: part and parcel of daily life for everyone. We must do our best to not give encouragement to others to make the wrong choice, but rather the right one.

THIRD YEAR MINISTRY

- v. 2 *little ones*: see Matt. 18:1-6.
- v. 3 *take heed* (Greek prosechō, 'to pay attention to' or 'to give diligent attention'. See Matt. 7:15; Lk. 12:1; Acts 8:6; 16:14; 20:28; I Tim. 1:4; 4:1, 13; Titus 1:14; Heb. 2:1; 7:13; II Pet. 1:19).
- forgive*: the command to do this is for everyone anytime repentance is in the other person's life. Remember that repentance can not be known except as expressed in actions. The fact of the change of mind could be stated, but only in daily activity would it become known (see the younger son in ch. 15). However, Jesus implies that we are to extend to the offender the benefit of the doubt in v. 4.
- v. 5 They considered the foregoing task as impossible in their present state of faith. It was seemingly an impossible thing to do what Jesus commanded them to do.
- v. 6 Jesus describes the actual power of faith, even in "small" quantity.
- v. 10 Even when we obey, we are not thereby deserving of commendation, because obedience was the minimum expected of the disciples.

QUESTIONS

480. How would a person get out of making daily decisions for or against doing God's will: by being a hermit, or refusing to find out God's will, etc.?
481. When would you decide to quit forgiving another?
482. Would you forgive them if God did? How would you know that they had not repented?
483. How difficult is it to plant a tree in the sea?
484. What is the point of the servant/master illustration in relationship to the preceding verses?

62. Bethany—John 11:1-52

John

- v. 1 The introduction of this family by John to his readers.
- v. 2 *who anointed*—this anticipates ch. 12:1ff.
- v. 3 *love*—see under John 21, and also v. 5
- v. 4 *not unto death*—we must understand death in a different sense than usual. Lazarus did die. Too, Jesus describes the state of Lazarus as sleep, as at the house of Jairus. See I Cor. 11:30 for a similar use of the word sleep. We conclude that death is not cessation of existence, anymore than sleep causes one to cease to exist, though the state of life has changed somewhat.
- glory*: death certainly can be a means to glorify God.
- v. 5 *Jesus loved* (the Greek word here is *agapaō*, but *phileō* in v. 3).
- v. 8 The disciples were aware of arrest attempts, and yet failed to understand that Jesus knew when and how He was to die.
- v. 9 Jesus probably means that He knows where He is going and what He is doing, just as a man walking in sunlight knows.
- v. 12 The disciples understood sleep as we do. But Jesus used it in a different sense.
- v. 14 *Lazarus is dead*: how did Jesus know this fact?
- v. 15 The miracle Jesus performed in raising Lazarus was a sign to the men, hence for their sake. It did not make some people believers, but it did many others.
- v. 17 It apparently took Jesus a day's travel to get to Bethany, while Lazarus died the day Jesus received the message that Lazarus was ill (he died after the messengers left Bethany to find Jesus, so they only told Jesus Lazarus was sick. Jesus must have known supernaturally that Lazarus died).

THIRD YEAR MINISTRY

- v. 21 Martha's faith in Jesus' ability ended at the point of death apparently.
- v. 22 We are not sure what Martha means here. Maybe it was just a hopeful remark.
- v. 23 Did Jesus reply to her remarks or her unspoken thoughts?
- v. 24 The O.T. does teach some things about a life hereafter. However, she may have heard Jesus talk about the after-life, and got this information from Him.
- v. 25 Resurrection and life are closely related, and especially so in relationship to a physical body.

Yet shall he live: Whether Jesus means that death in the physical realm does not affect the continuing existence of the spirit (the person), or that regardless of physical death, the body will ultimately be resurrected, we know not. He may mean that physical death does not affect the life He gives to those who accept that life (see the first part of v. 26 for this idea).

- v. 26 The statement must be understood in the area of the spirit, not the body.
- v. 27 A great statement of faith—God had revealed enough through the teaching and life of Jesus to convince her of the fact she confessed, even if she did not understand Jesus fully.

believe (Greek *pepisteuka*, meaning I have believed before and still do believe that . . . Christ).

- v. 28 Why Martha says what she does is unknown, since Jesus had not (at least recorded) asked for Mary. Perhaps Martha thought Mary would come if she knew Jesus wanted her to come, so that Jesus might also console her.
- v. 32 Mary's faith is in Jesus, even if she little understands

Him. She did not know that Jesus waited until the death of her brother for a specific purpose, v. 4.

v.33 *deeply moved* (Greek *embrimaomai*, as in Matt. 9:30; Mk. 1:43; 14:5; and here in v. 38. The word indicates great distress or agitation).

troubled (Greek *tarassō*, as in Matt. 2:3; Mk. 6:50; Lk. 24:38; Jn. 5:7; 12:27; 13:21; 14:1; Acts 15:24; 17:8; Gal. 1:7; I Pet. 3:14).

These descriptions of Jesus as He considered the death of His friend and the surviving sisters tells us that He too shares our deepest concern. They may well indicate a deeper understanding of the nature of sin and its results in the world than we even know. He came to die for sin, and perhaps this death of a friend, with His own death imminent, caused this reaction.

v. 38 *cave*: This may mean a cave in a hillside, or a cave in the ground. The Greek word occurs in Mk. 11:17; Heb. 11:38; Rev. 6:15.

v. 40 The text does not record that Jesus said to Martha the words He mentions, but He apparently did, whether at this time or in other conversations with her previously. He did express this idea to the disciples in v. 4.

v. 43 The "dead" man heard Jesus. This is what Jesus meant by His description of death as sleep. The "dead" are not "dead" to God, only to mortals. The real person (which is spirit) lives in a mortal body, which body ceases to function when the spirit leaves it, James 2:26.

v. 44 This ability to give life was mentioned by Jesus in Jn. 5:21, 26.

v. 48 The Jews as a people were chaffing under the Roman rule, and quite anxious to find someone to help

THIRD YEAR MINISTRY

them overthrow it. The council thought Jesus was a problem, however, since most of them wanted to keep the status quo, unless they could overthrow Rome in their own way. Since they could not use Jesus at all, they were quite anxious to remove Him from the scene and find someone whom they could use.

- v. 51 John's comments and interpretation of the remarks by Caiaphas.

into one: see 10:16; 17:21ff.

QUESTIONS

485. Where was this Bethany in relationship to Jerusalem?
486. When did Mary anoint Jesus with oil?
487. What did Jesus mean when He said that Lazarus' illness was not to death? Lazarus died, not once, but twice, did he not?
488. Why did Thomas think he and the other disciples would die if they went to Jerusalem? Had they been threatened or anything like that?
489. Did Martha think Jesus would have kept Lazarus alive if Christ had come before Lazarus died? How did she know Jesus could have done so, or did she?
490. Why did Martha say what she did in v. 22? Had she heard that Jesus had raised the daughter of Jairus, and the widow of Nain's son?
491. Did Martha consider that the Messiah was all Jesus said that He Himself was in vv. 25-26? Did all people hold this concept of the Messiah, do you think?
492. Why would Jesus become so moved about Lazarus when he knew that Lazarus would be raised from the dead?
493. Which person does the crowd have in mind in v. 37?
494. Jesus' prayer indicates that He already knew that

Lazarus would be raised, v. 42. If He could foreknow this event, could He not also foreknow the events prophesied in v. 51, 53?

495. Who comprised the children of God scattered abroad?
496. Did the resurrection of Lazarus convince all that Jesus was the Messiah? (Note 12:1-11)

63. Ephraim—John 11:54-57

John

- v. 54 The wilderness may have been along the western shore of the Dead Sea, and along the Jordan Valley.
- v. 55 Various things could cause one to be unclean and thus unable to participate in the Passover. Many went to Jerusalem early enough to become ceremonially clean so that they might keep the Passover feast. See Num. 9:9-14.

purify: Jesus emphasized moral purity, as in Matt. 15:1ff.; Lk. 11:37-41.

- v. 56 They really did not think Jesus would dare appear in Jerusalem.

QUESTIONS

497. If Jesus knew when and how He was going to die, why did He leave the area as He did, (apparently to keep from getting killed)?

64. Journey—Luke 17:11-19

Luke

- v. 11 The journey was probably intended to keep Jesus away from populous areas, and out of difficulty with the rulers like Herod Antipas.
- v. 12 Leprous persons were excluded from society, and lived with others having the same affliction.

THIRD YEAR MINISTRY

- v. 13 Like the man in Matt. 8:2ff.
- v. 14 It really took faith on their part to start walking away toward the temple, since Jesus did not say anything about healing them.
- Go (Greek participle *poreuthentes*, used to give a command. See Matt. 28:18).
- v. 16 The Samaritans had been treated like lepers by the Jews for ages. Leprosy apparently made a common bond which overcame that cultural problem.
- v. 17 Jesus knew that all were cleansed as they went, and also knew that one of the men was not Jewish.

QUESTIONS

498. Have you read Leviticus chs. 13 and 14 on leprosy?
499. Where does the Bible say it represents sin, or that lepers were treated as sinners?
500. Where in the Bible do you read that a person could become unclean by touching a leper?
501. What was the point of mentioning that a Samaritan returned to give thanks?

(2)—Luke 17:20-37

Luke

- v. 20 The message Jesus had been preaching all through His ministry (John also preached the same message) was "The kingdom of Heaven is at hand." These men might have wondered if the message were true, or in what way they were to expect it, etc.
- v. 21 As we understand this verse, Jesus meant that the kingdom and its adherents would not be like an earthly kingdom. Rather, the reception of the kingdom into one's life was a spiritual matter, even as Jesus taught in Jn. 3:3-8. With no earthly organi-

zation, or headquarters, or the normal trappings of an earthly kingdom, the one of which Jesus spoke would be greatly different than such as the men knew.

in the midst (Greek *entos*, as in Matt. 23:26).

- v. 22 The nature of the kingdom is tied to the nature of the Son of man. Hence, Jesus began a discussion of Himself. The following discussion seems to center around His second coming, with the exception of v. 25. Perhaps the death and resurrection of Jesus are considered by God as being inextricably bound to the second coming.
- v. 24 The sign of the second coming will be Jesus' personal appearance, and all will know when He comes again.
- v. 27 Jesus pictures "life as usual." The people were blissfully ignorant of impending destruction.
- v. 29 Notice: "on the day." The destruction was sudden and sure.
- v. 31 Point: don't be engrossed with material possessions when Jesus comes.
- v. 32 Lot's wife was an example of what people must not be, v. 31.
- v. 33 See Matt. 16:24-26.
- v. 34 The time is quite uncertain, as Jesus mentions night in this verse; but v. 35 depicts a daytime activity.
- v. 35 The point of v. 34-35 is two-fold. One point is that the kingdom is of such a nature that its adherents will be like other people in some ways (all sleep, work, etc.). The second point is that the second coming will be unknown, thus constant readiness is vital.
- v. 37 Jesus seems to mean that when the occasion merits the second coming, He will come, but not until.

QUESTIONS

502. Do you think those who ask the question in v. 20 might have wanted to pin Jesus down concerning what He had been preaching?
503. What was to happen before the coming of the Son of man?
504. Did Jesus say the kingdom had not come, or that it was already present?
505. What sort of general picture did Jesus paint about conditions prior to the coming of the Son of Man?
506. Will the coming be at a local place, or of a world-wide nature? (See Rev. 1:7).

(3)—Luke 18:1-14

Luke

- v. 1 Jesus wanted the disciples to feel that habitual prayer was to be an essential part of their life, because God was most interested in their requests.
- v. 2 The judge was not obligated to anyone was the picture Jesus drew. God, in contrast, loved the disciples dearly.
- v. 3 The O.T. had definite instructions regarding treatment of widows, Ex. 22:22-24; Deut. 10:18; and see James 1:27.
- v. 5 She was very persistent, and showed no signs of letting up. So he decided to help her, not for her sake, but his. God is not like that, Jesus pointed out.
- v. 7 Jesus emphasized that God would definitely do right by the elect; if not here, then hereafter. The widow meant nothing to the judge, but the elect meant all to God.
- v. 8 See 17:26ff. Little faith was found in the days of Noah or Lot, and when catastrophe comes again, the same general faithless state may be again found. Perhaps a part of the emphasis of this parable re-

NEW TESTAMENT HISTORY: THE CHRIST

volves around the contrast in the preceding chapter, i.e., between faith and lack of it. Constant faith in the life of the disciple would be evidenced by continued prayer.

v. 9 The faithless state can be evidenced even in prayer, however. So Jesus told a parable to illustrate that point.

v. 10 *Pharisee*: the self-righteous one.

tax-collector: considered by the Pharisee as the epitome of unrighteousness.

other men (Greek *hoi loipoi* 'the rest')

extortioners (the Greek word for 'to steal' or 'to snatch' as in Matt. 11:12; 12:29; 23:25; Lk. 11:39; Jn. 10:12, 28; Acts 8:39; I Cor. 6:10; II Cor. 12:2, 4; Phil. 2:6; Heb. 10:34).

unjust—ethically bad (in contrast to him, v. 9).

v. 11 See Luke 11:42.

v. 13 *beat* (Greek *tuptō*, as 'to strike' or 'to beat', a mark or type. See Matt. 24:49; Mk. 15:19; Lk. 6:29; Jn. 20:25; Acts 7:44; 21:32; 23:2, 25; Rom. 5:14; 6:17; I Cor. 8:12; Phil. 3:17; I Tim. 4:12; Tit. 2:7; Heb. 8:5; I Pet. 5:3).

v. 14 Justification takes place in heaven, not in the minds of men, Jesus pointed out.

QUESTIONS

507. Do you think there is any connection between the general state of faithlessness which Jesus mentioned in 17:26-37 and these parables emphasizing what true faith was and did?

508. What contrasts are evident between God and the judge?

THIRD YEAR MINISTRY

509. Did Jesus say that God would vindicate the elect on their time scale or God's time scale?
510. Can a person appear to be righteous outside and be full of dead men's bones on the inside, yet be unaware of that condition? (See Matt. 23:27-28; Lk. 11:44.)
511. Why was the tax collector justified? (See I John 1:8-10)

(4)—Matt. 19:1-12; Mk. 10:1-12

v. 3 *tested* (Greek *peirazō*, 'to test' or 'to tempt'). One can but wonder if they could ask Jesus a question without sinister motives.

divorce (Greek *apoloō*, 'to loose' or 'to set free'. See Matt. 18:27; 27:15-26; Mk. 8:9; Lk. 2:29; 6:37; 13:12; 21:28; Rom. 3:24; 8:23; Eph. 1:7; Heb. 9:15; 13:23.)

any cause—the world has not changed since their day!

v. 4 Sexuality is no sin: we were made that way. The sin comes when our bodies are misused, as in Rom. 1:26-27.

v. 5 *be joined* (Greek *kollaō*, as in Luke 10:11; 15:15; Acts 5:13; 8:29; 9:26; 10:28; 17:34; Rom. 12:9; I Cor. 6:16).

one—the reason why God hates divorce: it breaks up a unit. The text is not talking so much about a sex union (no one is engaged in sexual intercourse all the time) as it is what comes to be in a marriage. God views the husband/wife as a life-long unit, not to be split in two, v. 6, v. 7.

v. 6 God does the "joining." Our inability to decide just what constitutes a marriage in God's sight ought

NEW TESTAMENT HISTORY: THE CHRIST

to make us go very slow about uttering official pronouncements on the subject. Jesus did not elaborate, nor did any of the apostles, about this particular point. That a man and a woman could become husband and wife (thus excluding homosexual marriages) is clear. It seems obvious that mere sexual union is not marriage. David had such with Bathsheba, but that did not make them married.

There could be no such thing as adultery or fornication if every sexual union were a marriage. Joseph and Mary were considered husband and wife before any sexual union.

- v. 7 What they failed to see is that Moses did not command divorce, only commanded an official handling of a separation.
- v. 8 Divorce was never in God's plans.
- v. 9 One thing seems plain: divorce involves at least one person in sin, if not more. For that reason, it ought to be abhorred by every Christian.
- v. 10 The disciples reflected the current thinking of the time: if it does not work out, get a divorce.
- v. 11 Jesus indicated to them that some people for a valid reason might be able to abstain from marriage, but most could not.
- v. 12 Since God created man and woman for each other as the normal life relationship, anything else was abnormal. So marriage ought to be approached with the idea that it is right and good, and for life.

Mark

- v. 3 Moses: incidental for his authorship of at least this part of the Pentateuch, Deut. 24:1-4.
- v. 6 Quoting Gen. 1:27; 2:24.
- v. 7 joined (Greek *suzeugnumi*.) Related forms occur in

THIRD YEAR MINISTRY

Matt. 11:29-30; Lk. 2:24; 4:19; Acts 15:10; Gal. 5:1; I Tim. 6:1).

- v. 9 Jesus may be talking about the disruption of a union rather than an act which could result in such disruption .

QUESTIONS

512. Did people enter marriage in New Testament times like they do now: if it does not work out, we will get a divorce?
513. If a man can disrupt a union, Matt. v. 6, what part does man play in making a union?
514. How do cultural standards for getting married measure up to the Biblical statements (or does the Bible tell us what is necessary to become married)?
515. What was the certificate of divorce supposed to accomplish: show that the marriage was over or slow down the inclination to get a divorce?
516. Who is commanded (or permitted) to become a eunuch for the sake of the kingdom?
517. Why did Jesus not go into a lengthy discussion of divorce problems, such as plague modern civilization?

(5)—Matt. 19:13-15; Mk. 10:13-16; Lk. 18:15-17

Matt.

- v. 13 *lay*: probably defines "touch" in Mark and Luke. *rebuked* (Greek *epitimaō*, 'to rebuke', 'censure' or 'scorn').

let (King James "suffer").

Mark

- v. 14 *indignant* (Greek *aganakteō*, 'to be much displeased' or 'to be irritated', as in Matt. 20:14; 21:15; 26:18; Mark 10:41; 14:4; Luke 13:14; II Cor. 7:11).

- v. 15 *like*—probably in the same way, trustingly, without ulterior motives.

Luke

- v. 15 *infants* (Greek *brephos*, a small child, infant, as in Luke 1:41, 44; 2:12; 16; Acts 7:19; II Tim. 3:15; I Pet. 2:20).
- v. 16 The people with the nature of little children are the ones to whom the kingdom belongs.

QUESTIONS

518. For what purpose would people want Jesus to place His hands on their children and pray for them?
519. Did the disciples think Jesus was too busy or too indifferent to take time for the children? Did they judge Him by themselves?
520. Was the act of blessing the children the act of praying for them?
521. Did Jesus say a person ought to be childlike or childish?
522. How are we to be as a little child (since Jesus does not delineate the characteristics He had in mind, do we dare to be too arbitrary about what "as/like" means)?

(6)—Matt. 19:16-30; Mk. 10:17-31;
Luke 18:18-30

Matt.

- v. 16 *good deed*: perhaps he thought only one specific deed was necessary, either unknown to him or undone by him.
- v. 17 A question designed to probe the young man's attitude about Jesus.
- enter life*—we assume Jesus meant heaven. The Christian can have life both here and hereafter in Christ.
- v. 18 The moral precepts Jesus quoted were out of the

THIRD YEAR MINISTRY

Mosaic Law, under which the young man lived. He was obligated to keep them.

- v. 19 The "love for neighbor" the young man did not have, as Jesus quickly finds out.
- v. 20 *observed* (Greek *phulassō*, Luke 2:8; 8:29; 11:21; John 12:25, 47; Acts 7:53; 12:4; 23:35; 28:16; Rom. 2:26; Gal. 6:13; II Tim. 4:15; 5:21; II Pet. 3:17).
- v. 21 *perfect*: complete, mature, as God expects. Greek is *teleios*. Jesus does not indicate that treasure in heaven is equal to life eternal. However, the young man's heart would be there, Luke 12:34, thus he would ultimately be there too.
- v. 22 We wonder if the young man was sorrowful because of his riches, or because of his respect for Jesus, at least until that meeting.
- v. 24 The impossibility to get that for which the young man asked, except God help him.
- v. 25 Then as now, worldly possessions were considered a mark of God's good pleasure. But no one starts with a corner on God's favor—all are equal in this respect.
- v. 26 God alone had the ability to transform a man's life, John 3:5-8.
- v. 27 *everything*: exactly what eternal life costs, Luke 14:26ff.
- v. 28 This might have given James and John the idea to ask for chief seats a little later, Luke 20:20-28.
- v. 30 Explained in 20:1-16.

Mark

- v. 17 *good*—Mark adds this word to "teacher".
- v. 19 *kill* (Greek *phoneuō*, 'to commit murder'. The Old Testament command was also against murder, rather than killing in self-defense, etc. Much less con-

fusion would have resulted had the translations used 'murder' rather than 'kill').

defraud—Mark's account adds this statement, but leaves out the one in Matthew about loving one's neighbor. Luke's account does not have either of these commands.

- v. 21 Love does not save anyone in and of itself. For God, the gift of His Son was necessary. For man, the acceptance of that gift in faith, and the obedience to Jesus (John 3:36; 14:15) are both necessary.
- v. 24 amazed (Greek *thambeō*, 'to be astonished' or 'to be greatly upset' or 'to be in terror', as in Mk. 1:27; 10:32; Lk. 4:36; 5:9; Acts 3:10).
- v. 25 There is no good reason to postulate some small gate in the wall of Jerusalem as being the "eye" Jesus has in mind. He meant that without obedience to God, thus with God's help, no one could enter the kingdom. For all who obeyed God, eternal life was given to them, v. 30.
- v. 26 *exceedingly astonished* (Greek *perissōs*, 'exceedingly', *exēplēssōnto* 'to be struck out' or 'knocked out', especially in a figurative sense, ie., astonished).

Luke

- v. 18 *ruler*—perhaps a synagogue ruler, as Jairus was.
- v. 23 The parables in Matt. 13:44-46 have in mind such persons as this young man.
- v. 29 Jesus did not expect a "divorce" from such as parents, wife, husband, etc. He only demanded first place in one's life, which the young man obviously was unwilling to give.

QUESTIONS

523. Describe the man, and what he did when he got to where Jesus was.

THIRD YEAR MINISTRY

524. Why were the apostles astonished at Jesus' remark about the camel and the needles?
525. How much does it cost to gain eternal life? Does God compensate many times over for such "costs"?
526. Does the text indicate when eternal life begins?

(7)—Matthew 20:1-16

Matt.

- v. 1 Jesus pretty nearly compares the kingdom of heaven to the person of the king of the kingdom. The householder is equal to the king.
- v. 2 This is the only place in the New Testament where the wages for a day's labor is mentioned. In that time, often men worked from day to day. However, other means and methods of payment are found in the Bible, as Jacob with Laban, etc.
- v. 6 *eleventh hour*: probably close to 5:00 p.m. our time. See v. 12.
- v. 13 *friend*: a kind reply, in contrast to their murmuring.
- v. 14 *take* (Greek *airō*, 'to take up' or 'to take away').
- v. 15 *what belongs* (like the expression in Luke 2:49 which we commented on there). The Greek is *entois emois*, 'in the things of me').

what I choose: the point of the whole parable. The rewards for service in the kingdom are fair and right, but remain totally in God's hands.

QUESTIONS

527. What verse in chapter 19 does this parable in chapter 20 explain (remember that the chapter and verse divisions were put in the Bible over 1200 years after the Bible was completed)?
528. Was Peter's question in v. 27 sort of a "starter" for this parable?

NEW TESTAMENT HISTORY: THE CHRIST

529. Can anyone dictate to God about the conditions of salvation? If not, why do people argue with what the Bible discloses as the conditions upon which eternal life is gained?

530. Do you care who gets to heaven as long as you do?

(8)—Matt. 20:17-19; Mk. 10:32-34; Lk. 18:31-34
Matt.

v. 17 *going up*—Perhaps just outside of Jericho on the way “up” to the city of Peace.

v. 18 *chief priests, scribes and Pharisees*: the hierarchy in Jerusalem, basically intent on destroying Jesus.

v. 19 *mocked* (Greek *empaixai*, from *empaizō*, as in Matt. 2:16; 27:29, 31; Lk. 22:63; Heb. 11:37; II Pet. 3:3).

Mark

v. 32 The text does not specifically indicate who “they” is, though it may have been the 12.

amazed—as in v. 24.

afraid—probably because they feared what the Jews were planning for Jesus (cf. Jn. 11:16).

v. 33 *Gentiles*—Jesus accurately predicts the course of the trials.

v. 34 *he will rise*—possibly the point Jesus attempted to make, to alleviate their fear.

Luke

v. 31 *the twelve*—others were apparently in the party, but only the disciples were told about the passion of Jesus.

v. 34 Luke went to some lengths to make clear the fact that the 12 failed to comprehend what Jesus said.

QUESTIONS

531. How many different things did Jesus predict would

THIRD YEAR MINISTRY

happen to Him at Jerusalem? Was He a true prophet?

532. When (on or after the third day) did Jesus say He would rise from the dead according to the three accounts? (cf. I Cor. 15:4).

(9)—Matt. 20:20-28; Mark 10:35-45

Matt.

- v. 20 Probably Salome is the woman unnamed. Mark's account does not mention that she came with them. Perhaps they were all traveling together toward Jerusalem.
- v. 21 As the aunt of Jesus, she may have thought her request would carry more weight.
- v. 22 Lack of understanding characterized the disciples generally, and to a great degree sometimes. Jesus' mission and person seems so clear to us, but we might have done little better had we been in their shoes, without our hindsight.
- v. 23 Their work was cut out for them, even though unknown to them. However, God does the rewarding and bestows any greatness deserved.
- v. 24 The 10 had little right to complain—they probably wished they had thought of it first.
- v. 25 Jesus pointed out the common conception of greatness as seen in public personages, etc.
- v. 26 Notice: It shall not be so among you—no "ifs, ands or three ways" about it.
- v. 28 Jesus' life: our road map!

Mark

- v. 35 Notice that they wanted a "blanket" commitment before they asked—which Jesus did not give.
- v. 37 The right and left hand seats were considered to be the honored positions. Their conception of the coming kingdom is seen in this request.

- v. 38 God may use a person rather roughly to make them useful—He did Jesus.
- v. 40 God's idea of greatness and reward is doubtless far removed from their ideas.
- v. 41 *indignant* (Greek *aganaktēsis*, 'to be much displeased' as in Matt. 21:15; 26:8; Mk. 10:14; Lk. 13:14; II Cor. 7:11).
- v. 42 *lord it over* (Greek *katakurieuousin*. The stem is the word which is translated "lord" in its noun forms.)
- v. 43 *servant*—certainly not the disciples' idea of greatness.
- v. 44 If one desires to rule, service must be first, and always. The essence of true greatness is in service. We become great not because of being served but in serving.

QUESTIONS

533. How many factors can you name that might possibly have made James and John think they had a "right" to ask Jesus for the right and left hand seats?
534. Why did the brothers have a conception of the kingdom that would make them ask such things?
535. Does the world have false standards and examples of greatness?
536. Is true greatness in the "servant" or the "master" role? How many average church members believe what seems to be the obvious answer?
537. Is service a means of bearing fruit? (Cf. John 15:1ff.)

65. Jericho—Matt. 20:20-34; Mk. 10:46-52;
Lk. 18:35-43

Matt.

- v. 29 See the discussion of the textual problems in the section of exposition.

THIRD YEAR MINISTRY

v. 30 Matthew does not name the men, and remarks two were present.

have mercy—like the lepers in Luke 17. They specified to Jesus what application of mercy they wanted in v. 32.

Son of David—equivalent to the Messiah.

v. 31 *rebuked*—the same word used to describe Jesus' action in stilling the waves, chapter 9.

v. 34 *pity*—like He did in 9:36.

Mark

v. 46 If Mark recorded Peter's experiences, perhaps Peter remembered the blind man in great detail.

v. 47 *cry out*—as the demons did in 1:23 and 5:7.

v. 49 *take heart*—only in Mark's account. Only in the imperative mood in the New Testament. See Acts 23:11.

v. 50 *Mantle*—the himation, outer covering, as in Matt. 5:41, "cloak."

v. 52 *faith*: the touchstone to God's power.

Luke

v. 30 The text seems to indicate that Jesus had either already passed by or was such a ways off that he had to shout to be heard.

QUESTIONS

538. Could the accounts be retelling the healing of as many as three blind men?

539. Why did the blind man address Jesus as the Son of David? (See Matt. 22:41-45)

540. What made the blind man see (whole)?

Luke 19:1-10

Luke

- v. 1 The text makes Jesus' visit to Jericho seem planned, as if He intended to see Zacchaeus.
- v. 2 He in some way had become chief or overseer of the tax collectors, the regional head or its equivalent.
- v. 4 stature—*hēlikia*, as in Matt. 6:27.
- v. 5 Make haste (Greek participle *speusas*, used idiomatically as a coordinate with the imperative following: "hurry and get down!").
- v. 7 *sinner*: Zacchaeus would have referred to them that way, too.
- v. 8 Some argue that Zacchaeus had repented and was even that day going to do what he said. Others take him to be saying that such was his common practice.
- v. 9 Regardless of the interpretation of v. 8, the presence of Jesus was all that was needed.
- v. 10 An echo of the service Jesus mentioned in Mark 10:45.

QUESTIONS

541. Where did Jesus find Zacchaeus?
542. Does the text indicate that Zacchaeus was a Jew or a Gentile?
543. Why would Jesus talk about salvation to Zacchaeus? Was it the same kind of salvation mentioned in 18:14?

66. Road to Jerusalem—Luke 19:11-27

Luke

- v. 11 He was in the house of Zacchaeus, some 20 miles from Jerusalem.

Reference ch. 17:20ff. The kingdom of God was both present and future, and actually is yet to be consummated in some respects. Perhaps the prob-

FINAL WEEK

lem Jesus is combating is the idea of a materialistic kingdom.

- v. 12 Jesus is the nobleman.
- v. 13 The pound varied in worth, depending on whether silver or gold, and individual weight. The servants were to be busy, not shiftless.
- v. 14 Some suggest that Jesus was using the recent events surrounding Archelaus, who was treated somewhat this way. It seems rather farfetched to use a wicked man like him to represent the kingdom and Jesus.
- v. 15 Jesus ever taught responsibility and accounting of it.
- v. 21 He should have been afraid for a different reason than he was. He actually offered an excuse, not a reason, as v. 22 shows.
- v. 23 He did not do even what he could have done.
- v. 25 Notice the interest the listeners manifest.
- v. 26 No one can be neutral, or maintain status quo.
- v. 27 The fruitless servant, and the rebellious enemies were not different in principle: all were opposed to the noblemen.

QUESTIONS

- 544. What facet of the kingdom did Jesus emphasize in this parable, perhaps to point the hearers away from the idea that the kingdom was coming immediately?
- 545. Could the nobleman's journey into a far country be foreshadowing the crucifixion rather than referring to Jesus' ascension into heaven and remaining there until the second coming?

67. Bethany—Matt. 26:7-13; Mark 14:3-9;
John 12:1-8

Matt.

- v. 6 Simon's relationship to those who ate this meal is not known.

NEW TESTAMENT HISTORY: THE CHRIST

- v. 7 Identified as Mary in John.
- v. 8 *indignant* (see on Mark 10:41.) Very much so, as Mk. v. 4 shows.
- v. 10 Misunderstanding often causes disciples to wrongly judge the actions of others.
- v. 12 Jesus did not state whether Mary knew that the anointing was for His burial or just anointed Him, which resulted in the effect of getting Him ready for burial. For that matter, it is rather doubtful if any of the disciples believed He was going to be killed, thus needing burial.
- v. 13 The word "gospel" probably was not understood by the disciples in the sense we understand it today.

Mark

- v. 3 *sat*—the Greek word means reclined.
broke—perhaps Mark means that the jar was so sealed that the top must be broken off, etc., to get the ointment out.
- v. 4 *wasted* (Greek *apoleia*, elsewhere as destruction, ruin, etc.)
- v. 5 *reproached* (Greek *embrimaomai*, as in Mk. 1:43; Jn. 11:33. It means intense feeling, great emotion. The men were really upset with Mary).
- v. 6 Jesus as quickly shuts them up—He commended her and by the same action condemned the men.
- v. 7 Jesus said this to them, even though one could minister to Him by ministering to others, Matt. 25:34-40.
- v. 9 The story would be told because Mary manifested the right spirit and the disciples, led by Judas, did not.

John

- v. 1 John's account actually pinpoints the time of the feast, and shows its relationship to the triumphal entry. Matthew and Mark's account show the re-

FINAL WEEK

lationship of the event to the action of Judas in the betrayal.

- v. 3 The sight and smell doubtless both figured in the accusation of the disciples. Judas could both see and smell that "money" escaping his clutches.
- v. 6 Money box (Greek glōssokomon, from glōssa 'tongue' and komeō 'to tend' or 'to keep'. It first meant a small box to keep reeds in for musical instruments, and then to keep other items in, as money).

QUESTIONS

546. How many days prior to the Passover was this feast held? Prior to the triumphal entry? On what day does the text say the feast occurred?
547. In what respects does this anointing differ from the one in Luke 7:36ff?
548. Did Jesus forbid concern for the poor?
549. Did He teach that discrimination in expressing love is good?
550. Do you suppose Mary really thought Jesus was going to die? Was anointing normally done for people going to die?

68. Jerusalem—Matt. 21:1-11; Mk. 11:1-11;
Lk. 19:28-44; Jn. 12:9-19

Matt.

- v. 1 The immediately preceding text in Matthew's Gospel has Jesus coming up from Jericho. Matthew did not mention when the party left Jericho, or when they arrived at Jerusalem. None of the accounts actually spell out the day of the anointing, or the day of the triumphal entry.
- v. 2 The village is not identified. However, Jesus knew that the animals were there, and how He planned to use them.

NEW TESTAMENT HISTORY: THE CHRIST

- v. 3 Jesus' foreknowledge prepared the disciples for the request of the owners (Lk. v. 33) as to why the two animals were being taken.
- v. 4 We feel that Jesus, having spoken through His prophet Zechariah (9:9) about the event to take place 500 years in the future, deliberately did as He did to keep His own word.
- v. 5 *daughter of Zion*—Jerusalem. The action by Jesus and the acclaim of the crowds both signified one thing: Jesus was the king for Jerusalem. Ref. Luke 2:38.
- v. 8 John's account will describe two groups of people, one from Bethany with Jesus, one coming out from Jerusalem to meet them and share the grand entrance into Jerusalem.
- v. 9 A crowd of people on either side. No wonder the Pharisees were alarmed, especially if the crowds were as large as the crowd of 5,000 earlier, etc.
- Son of David*—how often this term has fallen from the lips of people. This is one reason why Jesus asked what He did in 22:41-45.
- v. 10 *stirred*—the same Greek word used to describe the storm on the Sea of Galilee, 8:24. They were greatly excited, as Jesus finally seemed to be making the move they desired one year earlier.
- v. 11 They affirmed that Jesus was "the" prophet—perhaps far short as we view it, but certainly distracting to the Jewish heirarchy.

Mark

- v. 2 Jesus knew the colt had never been ridden. An unbroken colt—we can only suggest that the colt knew its "real" owner!
- v. 3 The disciples were adequately instructed, even to the fact that the animals would be returned.

FINAL WEEK

- v. 4 Mark's account specifically tells where the animals were. Perhaps this is Peter's touch, if he were one of the two disciples.
- v. 10 The kingdom of David was in the angel's message to Mary, Luke 1:32.
- v. 11 Mark's account shows that evening had come, and after the arrival into the temple grounds, Jesus left. The next day, He will return and cleanse the temple a second time.

Luke

- v. 28 Luke, as Matthew and Mark, does not mention the anointing at Bethany. The next event Luke wished to record following the healing of Bartimaeus is the triumphal entry, which he does, without denying that other events may also have happened between the two he records.
- v. 35 Luke notes that the disciples helped Jesus to sit on the colt.
- v. 37 The accounts seem to indicate that Jesus rode up the Mount of Olives, over the top, and down the west slope into Jerusalem.
- v. 39 Matthew had recorded the question about Jesus' identity. Luke records that Pharisees also had something to say, though not complimentary.
rebuke—The Pharisees wanted Jesus to shut the crowds up, as the acclamations of praise for Christ doubtless infuriated them no end.
- v. 40 The following verses will indicate that the Pharisees had so turned the city of Jerusalem against Jesus, that it caused Christ to cry out.
- v. 41 Perhaps this occurred even as He rode down toward the Kidron valley and up into the city.
- v. 42 *the things that made peace*—the acceptance of the Prince of Peace—were hopelessly hidden from their eyes, even as they wished it to be so.

NEW TESTAMENT HISTORY: THE CHRIST

- v. 43 Jesus will speak again in 21:20 about the same event. Titus and the Roman armies in A.D. 68-70 were the things of which Jesus spoke.
- v. 41 The people of Jerusalem did not know when they had been visited, because of hardened hearts, unseeing eyes, unhearing ears.

John

- v. 9 The raising of Lazarus had only been a short time before, perhaps a month or two, and some had not seen Lazarus since his resurrection.
- v. 11 It is a frightening thing to consider that one's heart could become as hard as the men spoken of in our text—but it can! But others could and would see Christ for what He really was, and thus it ever is.
- v. 12 John indicates that the supper took place on one day, and seemingly implies that the next day Jesus rode into Jerusalem. However, the text could be understood differently. The entry into Jerusalem took place the day after the crowds learned Jesus was in Bethany and came to see Him. Whether this occurred the same day as the supper is not too clear. Another item to consider is that a new day would start for the Jews at sunset, which would leave time to ride into Jerusalem before dark.
- v. 13 *palm branches*—the trees normally do not grow in too cold of climate, so this tells you something about Jerusalem's climate, or at least the surrounding area.
- v. 16 John has remarked before about the failure of the disciples to understand what Jesus did. The synoptics likewise record their denseness at times.

QUESTIONS

551. Why would Jesus tell the two disciples to bring both the colt and its mother?

FINAL WEEK

552. How do you suppose Jesus knew about the two animals, and all that transpired concerning them?
553. Do you think Jesus deliberately fulfilled prophecy?
554. What reactions did Jesus get from various people during the ride into the temple?
555. What was the significance of this event for the crowds of people?

69. Matt. 21:18-22; Mk. 11:12-14, 20-25

We will consider this event as a whole, though it actually involved two days. Mark shows that the cursing took place one day as Jesus was going to Jerusalem, while the conversation about how quickly it withered took place the next morning, with the cleansing of the temple sandwiched in between. The discussion probably occurred on the same day as the events in #72.

Matt.

- v. 18 This is the second of a succession of perhaps four days, as the various accounts are studied.
- v. 19 *at once*—but the fact that it withered was not noticed until the next morning.
- v. 21 The moving of a mountain could be done, if God so wills, and faith puts one in touch with God.
- v. 22 Jesus will promise this again in Jn. 14:13-14. It had the limitation of faith attached to it.

Mark

- v. 12 Just why Christ would leave Bethany without eating is perplexing. However, He may simply have not had time to eat, or got hungry because He had been walking, etc.
- v. 13 The remark about the season reminds the reader that it was springtime, not the normal harvest time for figs.
- v. 20 The third of four successive days.

- v. 21 Mark's account reveals that the statement of Jesus to the tree was heard, the effect of it seen the following day.
- v. 23 *does not doubt*—the same Greek expression as in James 1:6.
- v. 24 *believe that you shall*—faith in God's desire and ability to help can be the bedrock of every prayer, Luke 18:1ff. However, consideration of God's will in the matter is the third foundation stone in any disciple's prayer, I Jn. 5:14-15.
- v. 25 The same sort of conditionality as in Matt. 6:14-15.

QUESTIONS

- 556. What makes you think Jesus acted like we do sometimes—in vindictive anger—and condemned a tree that really had nothing to do with the fact that it had no figs?
- 557. Why would the disciples not notice the tree was withered until the next day?
- 558. How much can faith accomplish? (Cf. Lk. 17:6.)

71. Bethany—Matt. 21:17; Mk. 11:19

72. Jerusalem—Matt. 21:12-16; Mk. 11:15-18;
Lk. 19:45-46

Matt.

- v. 12 This action of Jesus was a tremendous attention getter, plus having the effect of alienating many of the crowd against the Pharisees. Coupled with the auspicious events of the preceding day, the gauntlet had been thrown by Jesus squarely at the feet of the Jewish hierarchy.
- v. 13 The passage is from Isaiah 56:7. Notice that Mark, v. 17, has an additional phrase to the effect that all nations were to find God in His house.

FINAL WEEK

- v. 14 Many went away from this Passover, never to forget the intervention of God in their lives, both physically and spiritually.
- v. 16 Psalms 8:2. The men were so far out of focus, that they were finding fault with what was right, while sanctioning what was wrong. Isaiah had recorded such a character of the Jews centuries earlier, 5:20-21.
- v. 17 The same action in Mark 11:19. Perhaps He went to a house furnished Him by the disciples. Luke 23:37-38 indicates that sometimes He may not have gone to Bethany, or perhaps the house was located near Bethany, but also near the Mount of Olives.

Mark

- v. 16 Notice that the whole temple area, some 30 acres, was cleared, and the people no longer permitted to make it a thoroughfare.
- v. 18 No doubt this action by Christ was nigh to incredible in many ways, not only in defiance of the temple hierarchy, but in the total thrust of what it claimed for Jesus Himself.

Luke

- v. 46 Jesus described the temple, God's house, as having been totally changed in character to that of a dwelling place for thieves—a vivid description.

QUESTIONS

559. Since the people actually needed sacrifices to offer, and the proper Jewish coinage to give, why did Jesus take such violent measures?
560. Did the temple grounds resemble a sale ring, do you suppose, with barkers, etc.?
561. Did Jesus consider that the praise from the children was justified? If so, what exactly did they proclaim concerning Him?

NEW TESTAMENT HISTORY: THE CHRIST

562. Do you think the Jewish priests and scribes had a vested interest in the temple which kept them from even admitting what many others openly confessed about Christ?
563. Had the men really decided to kill Christ?
72. (1) Jerusalem—Matt. 21:23-27; Mk. 11:27-33; Lk. 19:47—20:8

The reader will note that we break the text down into smaller sections than in the exposition. However, when Jesus was asked concerning His authority to do what He did, His answer covers all the material through Matt. 22:14 and the parables. We discuss His answer in four separate sections here.

Matt.

- v. 23 The priests and elders intended to destroy Jesus some way. Of course, as they did with John earlier (Jn. 1:19ff.) they considered that Jesus had not received their approval for what He was doing, and thus should be handled accordingly.
- v. 20 *question* (Greek *logos*)—a favorite way to answer by Jesus. He really hit a "sore spot."
- v. 25 *argued* (Greek *diologizomai*, as in Matt. 16:7; Mk. 2:6; Lk. 1:29)—they were in a quandry to say the least, as their discussion proves.
- v. 26 You can easily see why Jesus held the men in small esteem—they were hypocrites through and through.
- v. 27 The basis for reasoning about authority was different, hence the conclusions could not be the same. Jesus showed what always must be considered in any discussions: the presuppositions of those in the discussion.

Mark

- v. 27 *walking*—perhaps Jesus strolled around, both teach-

FINAL WEEK

ing and asking questions. Remember, too, that He may have had some difficulty keeping people from carrying things through the area, Mk. v. 16.

v. 30 Mark indicates Jesus was as demanding of His interrogators as they were of Him.

v. 31 In imagination, one can see their efforts to figure out how to answer Jesus so as not to lose face before the people, all the while pretending to have the situation well in hand. The crowds standing around watching and listening, doubtless enjoyed the discomfort of the hierarchy immensely.

believe—it is equal to obedience, since it involved being immersed by John.

Luke

v. 47 The text of Luke may well go with vv. 45-46. We will treat it here, since little difference is made where we place it. Note that Luke shows the opposition to Jesus was from three separate groups of Jewish leaders.

v. 48 *hung* (Greek *ekkremanumi*, as in Matt. 18:6; 22:40; Lk. 23:39; Acts 5:30; 10:39; 28:4; Gal. 3:13).—The crowd to a man was suspended by what Jesus taught, in vivid contrast to their religious leaders.

20:1 *preaching the gospel*—This only tells us how much of what Jesus said and did is not recorded. We again remark about the use of the word "gospel" prior to Pentecost, and probably in a different sense than in I Cor. 15:1ff. See Matt. 4:23; Mk. 13:10.

v. 6 *stone us*—they really feared the people. See why then they reacted as they did, as recorded in Mk. 14:10-11.

QUESTIONS

564. Name the groups among the Jewish leaders who came to question Jesus.

565. Why did Christ ask them a question back?
 566. If the men had answered that John's immersion was from heaven, would they have indited themselves?
 567. What made the people think that John was a prophet? What did they do about it?
 568. Were the men unable to decide about John's immersion, or unwilling to say what they were thinking?

(2)—Matt. 21:28-32

Matt.

- v. 28 It was a command, but the son at first disobeyed.
 v. 29 The ultimate response to the command was obedience, which was the actual desire of the father.
 v. 30 The Greek construction indicates that the son, with a show of outward committment, responded affirmatively: "Sure, dad, you can count on me!"
did not go—fine words are not equal to fine deeds.
 v. 31 They could readily discern obedience. But they could not discern their sad spiritual condition. Those they counted so contemptuous were the ones who finally realized they were "sick" and needed the great physician, Jesus.
 v. 32 So the first last and the last first. The issue of authority is highlighted in real life.

QUESTIONS

569. This parable of the two sons was told to sharpen up the fact that the religious leaders were disobedient to authority: did it accomplish its purpose?
 570. Is profession equal to performance?
 571. What did Jesus mean in v. 31 by "the way of righteousness?"

(3)—Matt. 21:33-46; Mk. 12:1-12; Lk. 20:9-18
Matt.

- v. 33 This parable will also delineate the issue of authority, including the Jewish nation in general, its religious leaders in particular.
- v. 34 *season of fruit*—The owner expected a just accounting of the tenant's stewardship, and he expected fruit. The parable of the pounds in Lk. 19, and the talents in Matt. 25, show that God expected increase, not maintenance of the status quo.
- v. 35 See Matt. 23:29-30.
- v. 38 How wicked they were—and how poorly they reasoned, for if the owner was yet alive, the killing of the son would hardly give them the inheritance. It would rather redound against them, as Jesus showed in v. 41.
- v. 40 Notice Jesus is pictured as asking the crowd what the owner would do in Matthew's Gospel, while Mark and Luke record that He spoke the same thing as the crowd replied. We understand Matthew to record that Jesus actually asked a question, and when the crowd answered, He agreed with their analysis, which agreement is essentially what Mark and Luke record.
- v. 41 The crowd is very much attentive, which is why the Jewish rulers were so mortified when they were bested by Jesus. See vv. 45-46.
- v. 42 Note the emphasis upon what the Lord did in regard to the cornerstone that was rejected by the builders. See Acts 2:36, 4:11.
- v. 43 Even as the people rightly judged should happen, v. 41, the Lord was going to quit dealing with the Jews as a nation, and look elsewhere for those who wanted to serve Him.

produce the fruits—see the following scriptures on

NEW TESTAMENT HISTORY: THE CHRIST

the N.T. concept of bearing fruit: Matt. 3:8-10; Lk. 3:8-14; Jn. 4:35-38; 15:1-8; Rom. 1:13; 6:21-22; 7:4-6; 15:5-29; II Cor. 9:6-14; Gal. 6:7-10; Phil. 1:11; 4:17-18; Col. 1:6; 9-12; Heb. 12:11; 13:15; James 3:17-18; II Pet. 1:3-11; Jude vv. 10-16.

- v. 45 They did not need to be too perceptive to get the conclusion they did. Jesus made it fairly clear.
- v. 46 *a prophet*—it was not all Jesus wanted, but it was more than the leaders admitted to.

Mark

- v. 1 The vineyard was a familiar idea, and a common piece of property rented out to others.
- v. 6 *a beloved son*—Luke, v. 13, has the owner thinking to himself that surely the tenants would respect his son, since it was his own flesh.
- v. 9 Perhaps Jesus responded as the crowd did in answer to His question, Matt. v. 40.
- v. 12 They apparently did not try to arrest Him too openly, but simply wanted to do so very badly.

Luke

- v. 9 *a long while*—some 14 centuries God had given the the nation, but they were wicked and adultrous the whole time as a general rule. First the sorrowful period of the judges, then they wanted a king. God then sent prophets to help the kings, but the nation treated them shamefully. The cruel hand of the Babylonian empire could scarcely bring them to repentance, which soon faded into empty words and vain ceremony.
- v. 16 The crowd had rightly judged the owner's response, and Luke records their reaction to their own appraisal, as they realized the application to their nation.

FINAL WEEK

- v. 17 Jesus points out that the Psalmist had foretold just such a happening.
- v. 18 Dan. 2:34-35; Rom. 9:33. God's plans would not be thwarted, regardless of the endeavors of men.

QUESTIONS

572. Apply the parable to the nation as Jesus' listeners applied it.
573. Is any trust from God, given into our lives, to be treated as a sacred stewardship?
574. How many ways does the N.T. teach we can be fruitful?
575. Had God foreseen that the Jewish nation would be replaced by another class of people?
576. Did the parables depict how God's prophets and beloved son would be treated? (Do you think Jesus also understood this?)

(4)—Matt. 22:1-14

Matt.

- v. 1 This last parable presents again the issue of authority, first in the rejection of the king's invitation by those initially invited, then in the refusal of the one man to dress as he was expected to dress.
- v. 2 *a marriage feast*—imagine getting invited to a marriage feast for a prince, and not going! See the marriage feast of the Lamb described in Rev. 19.
- v. 3 *call those invited*—the king had first informed people that a feast was in the offing that they might be prepared, and then sent his servants a second time to tell them the time had come.
- v. 14 A third chance!
- v. 5 *made light*—they neglected it, so were really discourteous. The reasons they had were not good

- reasons. We need to beware lest we neglect the important for the urgent.
- v. 8 What the first people invited did not realize was that the king's invitation was not of merit but grace. They were not invited because of their own virtue, but because of the value of His son.
- v. 10 *bad and good*—the kingdom was for all, Jesus implied.
- v. 12 However, the invitation was still conditional: not only did those invited have to decide to attend, they also were to have worn a garment.
- wedding garment*—in the drapery of the parable. We assume it was furnished, but Jesus did not so say. What this represented in connection with the kingdom is not said either, and we simply speculate in whatever we suggest.
- v. 13 The real tragedy: not getting thrown into outer darkness, etc., but in missing the wedding feast.
- v. 14 The chosen are equal to the ones who were worthy, v. 8. These were the ones who respected the invitation enough to respond as they were expected to respond. Please note that there was no essential difference between this man and the ones who earlier refused to come: all missed the feast. Some were indifferent, some opposed, some insolent: all disobedient.

QUESTIONS

577. Is the Bible picture of the kingdom often one of feasting?
578. What were the excuses offered for not coming to the feast?
579. Do you think people today reject the kingdom for the same general reasons?

FINAL WEEK

580. Why was the man who had no wedding garment on speechless?
581. Did Jesus say what the wedding garment represented in the kingdom?
582. What kind of punishment do those receive who failed to attend the feast?

(5)—Matt. 22:15-22; Mk. 12:13-17; Lk. 20:19-26

Matt.

- v. 15 *counsel* (Greek *symboulion*, as in Matt. 12:14; 27:1; 26:4; 28:12; Mk. 3:6; 15:1; Jn. 18:14; Acts 9:23; 25:12; Rev. 3:18.

entangle (from a Greek word *pagis*, a trap). These men really were pure in heart!? Cf. Lk. v. 26.

talk (Greek *logos*).

- v. 16 Seldom did the Pharisees and Herodians work together. However, they had a common foe in Jesus, Who they thought was going to cause an uprising against Rome, and upset the status quo.

true—thus they imply would not equivocate or avoid the issue at all.

care for no man—they were actually tongue-in-cheek, but Jesus knew that they really did not mean what they said at all.

do not regard—they imply that Jesus will “let the chips fall where they may.” But when He did, they got covered up with them, and did not like it at all.

- v. 18 *malice* (Greek *ponēria*, generally wicked, sinful, bad, as in Lk. 11:39; Acts 3:26; Rom. 1:29; Gal. 1:4; Eph. 6:12; Heb. 3:12; 10:22; I Jn. 3:12). Jesus knew they were wicked, and evil in intent, which is why He asked them about testing Him, and called them fakes.

NEW TESTAMENT HISTORY: THE CHRIST

- v. 20 The custom of putting the likeness of the governor or emperor on coinage had begun earlier, and gradually spread to various countries. Some rulers did it, others not.
- v. 21 Jesus recognized one's allegiance to both earthly and heavenly realms, just as He did in vv. 37-40.

Mark

- v. 14 *the position of men* (the Greek has "do not see the face of men," ie., Jesus is not concerned about whether He "lifts up their face" by favoring them or not).

truly (Greek "in truth").

should we pay—they wanted Him to make a decision, so that they would be able to act accordingly.

Luke

- v. 20 *spies*—Jesus had warned about "wolves in sheep's clothing" on another occasion in a different context, but He could have said some more here. He did label them hypocrites, which is close.

sincere (Greek *dikaioi*, 'righteous').

deliver him up—their wicked hearts were going to produce evil deeds, just as Jesus said in Mk. 7:1-23. The Greek word (*paradidōmi*) is the word for betray.

- v. 21 *rightly* (Greek *orthos*, 'correctly', 'without deviating', as in Mk. 7:35; Lk. 7:43; 10:28).

QUESTIONS

583. What character of men came to ask Jesus the question about the taxation?
584. Why did Jesus say Caesar had a right to receive taxes?

FINAL WEEK

585. Does a disciple have an obligation to support those who minister to him? (Cf. Rom. 13:1-10.)
586. Should one always tell the truth regardless of who gets hurt or when?

(6)—Matt. 22:23-33; Mk. 12:18-27; Lk. 20:27-40

Matt.

- v. 23 The Jewish hierarchy must be given credit for one thing: they were persistent in their attempts to "get" Jesus.
- v. 24 Deut. 25:5-10. The law was to insure the continuance of the family name, and someone to inherit the family property.
- v. 28 The question assumed that the next life would be a replay of this one. They thus propounded a question that would have taken more than Solomon's wisdom to settle it.
- v. 29 *You are wrong*—the voice of authority at which the people often marveled, the demons obeyed, the wind and waves heeded, and the dead responded.
- v. 31 Jesus did not deny cessation of personality so as to make impossible the recognition of persons (angels are separate and distinguishable entities) but rather affirmed they were both ignorant of the conditions in the future state, and of the power of God (to overcome death, etc.).
- v. 32 The text, though concerning men of faith, is being used by Jesus to prove the fact of the existence of personality when what we know as death occurs. As God has life within Himself, so He created all men immortal in spirit, though not everyone will enjoy the blessings in Christ, which are optionally received as men believe in Him.
- v. 33 no doubt, the crowd had heard the question argued endlessly, with no apparent solution.

Mark

- v. 19 *Moses*—the one who would accuse them and the rest of the Jewish hierarchy, because of their disbelief in Christ, of Whom Moses wrote.
- v. 24 Jesus pointed out the exact problem: ignorance of God's Word. There is no substitute for knowing it. There is an infinite difference between knowing what the Book says, and what men say about it.
- v. 26 Jesus actually clarified the expression in v. 25 "when they rise from the dead" by this verse, which shows that men really do not rise from the dead, because men do not die. Death is the word used to describe the separation of the spirit from the body, which leaves the body in a state called death. The word "death" is then used in other ways, but the beginning point for understanding it is this point.
- v. 27 *quite wrong* (Greek *polu planasthe*, 'much wrong' or 'greatly astray from the proper courses').

Luke

- v. 28 Interestingly enough, Jesus was the One Who inspired Moses to write what they quote.
- v. 36 Angels and sons of God are thus different.
equal—that is, death is not possible, since such beings as angels do not cease existing.
- v. 38 Death may change our relationship to this material world, but not to God.
(As an interesting textual note, some Greek manuscripts place the account in Jn. 7:53b-8:11 after this verse.)
all live—in contrast to the doctrine of the Sadducees, which taught that no one lived after death.

QUESTIONS

587. Describe clearly the metaphysical position of the Sad-

FINAL WEEK

ducees, so that their question about life after death may be viewed in proper perspective.

588. Of what two things were the Sadducees ignorant? Did it affect their conclusions on some subjects, so that they were far astray, like wandering planets?
589. How many people is God the God of?
590. What would be the difference between saying "God was the God . . ." and "God is the God . . . ?" (Do you see now the implication of Jesus' "I am" in Jn. 8:58?)

(7)—Matt. 22:34-40; Mk. 12:28-34

Matt.

- v. 34 *silenced* (Greek *phimoō*, as in Matt. 22:12; Mk. 1:35; 4:39; Lk. 4:35; I Tim. 5:18; I Pet. 2:15).
- v. 35 Mark's account indicates that the scribe who asked this question was somewhat more receptive to Christ than others of his class.
- v. 36 *great* (Greek *megalē*, either in rank or quality). The answer Jesus gave showed that a willed devotion to God and one's fellow created beings was both first in rank and greatness. All other commands were (and are) simply applications of these two precepts.
- v. 37 God will not honor the person of a divided life, as Jesus so often pointed out, Matt. 6:24; 12:30; etc.
- v. 38 The first was Deut. 6:4ff.; the second Lev. 19:18. The Decalogue is easily seen to be but examples of these two precepts, for instance.
- v. 39 Notice: love may be an innate principle of each person, but how that love is expressed is the function of our will. Hence we may or may not love God, as we choose, though we will love something else if we will not love Him.

Mark

- v. 28 *first of all*—remember the rich young ruler? Per-

- haps this man actually wanted to know which of the many was most important. Jesus spoke of many heavy burdens the Pharisees and scribes bound upon people—maybe this man was earnest in his request, because he really cared to know. At least Jesus saw something extra in him, v. 34.
- v. 29 *is one*—not one in personality, but undivided in purpose, etc. That is why Jesus could say what He did in Jn. 5:19; 14:9; etc. For the use of the Greek word translated one (*heis*) see Jn. 17:11, 21, 22, 23; I Jn. 5:8.
- v. 30 We may not know the exact distinctions Jesus had in mind, but He meant the total person. See Lk. 9:62.
- v. 31 The two commandments Jesus gave are inseparable. Note the answer of the scribe in Lk. 10:25-28.
- v. 33 The scribe truly was perceptive, because he had apprehended that to be outwardly righteous but inwardly not was to totally fail in what God wanted of a man. As Jesus pointed out in Lk. 11:37-42; the whole life must be right before God. This was lacking in King Saul's life, I Sam. 15, for example. Obedience was better than any sacrifice, but love was essential to any obedience, I Cor. 13.
- v. 34 After this, Jesus asked the questions.

QUESTIONS

591. Would you like to know which commands God thinks are most important?
592. If you could ask Jesus the same question as the scribe, do you think He would give you the same answer?
593. Why can the two commandments not be separated, except in discussion of them?

FINAL WEEK

(8)—Matt. 22:41-46; Mark 12:35-37;
Lk. 20:41-44

Matt.

v. 41 One of the Pharisees had just asked Christ a question, now they were to get one back.

v. 42 *Christ*—Messiah to the Jews. The reason for the question was to point out their false concepts of the nature of the Messiah, which actually was the stumbling block in the way of acceptance of Jesus.

son of David—thus the meaning at least overtly of many cries Jesus heard, as in Matt. 20:30; 21:15.

v. 43 Jesus pointed out that David was directed by the Holy Spirit to write at least Psalms 110:1. Peter said in Acts 2:30 that David was a prophet.

v. 44 The connection was that the Messiah was indeed to be a descendent of David, but possessed of divine nature. (If the Holy Spirit be different than these two, then three personalities have the quality of deity.) The Pharisees had missed the last point.

Notice: two personalities possessing deity are mentioned by Jesus. See Heb. 1:13.

v. 45 The point: the Messiah was to be both human and divine.

Mark

v. 37 David at least spoke of the connection between his offspring according to the flesh and according to the Spirit. See Rom. 1:3-4 where Paul makes the same point, that David's son was also David's God.

Luke

v. 42 the book of Psalms—Jesus put the whole collection of 150 psalms in one book. See Lk. 24:44 where He mentions them again.

QUESTIONS

594. As mentioned in regard to the Sadducees, do presuppositions determine conclusions? Did the Pharisees and scribes draw the wrong conclusions because of a wrong presupposition?
595. Describe the Messiah (Christ) as David described him. Did Jesus fit the picture?
596. Do we need to understand completely how Jesus was both man and God before we accept the fact? (Do you suppose anyone ever has known how He was both?)

(9)—Matt. 23:1-39; Mark 12:38-40; Lk. 20:45-47
Matt.

- v. 2 The men taught the law, perhaps in every city, Acts 15:21. Moses was generally synonymous with the whole law, Jn. 1:17.
- v. 3 No one practices as well as he preaches. We should hardly expect anyone to do so. Consistency is not humanly possible very much of the time. We should care very little, if the messenger tells us what God wants of us, if he does not practice as he preaches. After all, we are obligated to live as we understand, and we are not judges on the basis of how anyone else lives. We like to offer such weak excuses to God as the fact that the "preacher" does not do like he is supposed to, but I doubt if such excuses are acceptable with God.
- v. 4 Some burdens were taught by word, others by deed. Hence, Jesus sometimes found fault with their interpretation, other times with their lives.
- v. 5 *phylacteries*—a little leather box strapped either on the arm or on the forehead containing small phrases of the law, such as Deut. 6:4; etc. See Ex. 13:3-9;

FINAL WEEK

Deut. 6:5-9; 11:18-25. The Jews interpreted the idea in 6:8 literally.

v. 6 See Lk. 14:7-11 where Jesus condemned such things. False ideas of greatness are also mentioned by Jesus in Matt. 20:25-28.

v. 7 See Matt. 6:1ff. where Jesus taught about this practice.

v. 8 The point: all are interpreters, and none are to consider his or her interpretation as anything but that: a human conclusion about a divine revelation. If people could have seen this point in the Restoration movement, and in all of Christendom, much less heartache and division would have occurred.

v. 11 Selfishness is to be absent from every disciple's life.

v. 12 See James 4:10; I Pet. 5:6.

v. 13 *shut the kingdom*—because they so obscured the the right attitude, etc., that men did not know the right way when they saw it—or did not want it.

hypocrites—such people drew the strongest denunciation of anyone by Jesus. See Lk. 11:52.

v. 15 Judiasm was not a missionary religion in the same sense Christianity is, but apparently some efforts were expended by the men.

v. 16 There was no difference between the gold, and the temple. Of course, the Jewish leaders did not broadcast it around that they practiced such hypocrisy, but such action would finally be known.

v. 18 The altar really sanctified the gift, but both were equally traceable to God. They simply were evading the real essence of godliness by such practices.

v. 22 The men needed to see that God made everything, and that material things really could not guarantee the integrity of anyone's word. The character of the person himself was the only real mark of integrity. Anything else came of evil, Jesus said, since

- any other effort to make one's word credible might well indicate that one's word was not good.
- v. 23 The practice of tithing was obligatory upon the Jews. It is not upon any Christian—thus this verse, and others like it in the Gospels are quite incorrectly used by preachers, etc., to “bind” tithing upon Christians. The whole N.T. is against such a law system, as Acts 15:1ff., and the whole book of Romans, and Hebrews (just to mention 3 of 21) are likewise opposed to it.
- v. 24 The King James version reads “at” rather than “out.” It is a mistake in translation that was never corrected in all the various revisions of that particular version. For those readers who are unaware of it, the version of King James that is currently sold today is a revision made in the decade of 1760-1770. Many revisions of the version put out in 1611 had been made prior to the one afore mentioned. Readers today would have considerable trouble reading the original version put out in 1611.
- v. 25 They were concerned only with externals, which was not enough. Inside, they had the character of thieves and robbers.
- v. 27 *whitewashed*—all tombs otherwise unmarked were to be in some way identified prior to Passover time, so that people coming to the feast would not unintentionally make contact with them and defile themselves, Num. 19:11ff.
- v. 28 As Eph. 2:1 pointed out, people could be dead while living.
- v. 29 By their efforts, they ostensibly proclaimed that they were honoring the prophets. However, as Matt. 15:7-9 states, such was not the case. Their exceedingly transparent characters to the eyes of Jesus were pointed in the parables of Matt. 21:33-46.

FINAL WEEK

- v. 32 The "filling" would take place on Friday of the week in which Jesus was speaking, resulting in His crucifixion. Actually, they were worse than their fathers, in that they planned to kill the heir.
- v. 36 The seige and destruction of Jerusalem and the nation is predicted once again.
- v. 37 Jerusalem means "city of peace."
- v. 38 The nation had left Jesus, now He was leaving them. desolate (Greek *erēmos*, 'to abandon' or 'empty'. See Matt. 14:13; Mark 1:35; Lk. 1:80; Acts 1:20; 7:30; 21:28; Gal. 4:27).
- v. 39 A change of attitude would be necessary before He could be welcomed by them. See Lk. 13:35.

Mark

- v. 38 *long robes*—plus the fact that the fringes were made broad, to catch the eye of onlookers.
- v. 40 The trait of character mentioned in Matt. v. 25 is seen here. Whether "widow's houses" were actually houses or not is debatable.

Luke

- v. 46 *Beware*—they were to be listened to when they taught the law, but not mimiced in life. See Paul's comment in I Cor. 11:1.

QUESTIONS

597. Why did Jesus forbid the people to "not do as the scribes and Pharisees" did? Did they not preach what was God's will?
598. How far should we mimic (follow) the lives of others? (Did Jesus leave us an example?)
599. Did you ever "turn off" a preacher because you thought he did not practice what he preached? (The scribes and Pharisees did not practice what they

preached, but Jesus did not say anyone was excused from listening to *what they taught.*)

600. If you refused to listen to anyone who did not practice as he preached, how many people could you listen to?
601. What relationship did Jesus say all disciples sustained to each other?
602. What disciple has the right to command other disciples? (Who has any authority?)
603. Should we convert men to "our system" or to Christ? (How could we convert them to our system by claiming to have an infallible interpretation?)
604. Why do oaths come of evil? (Cf. Matt. 5:33-37.)
605. What will make your word trustworthy?
606. Why are justice and faith and mercy weightier matters than tithing?
607. What is the meaning of the figure of speech in v. 26?
608. How were the men to whom Jesus was speaking like their fathers who killed and stoned the prophets?
609. How could the generation to whom Jesus spoke murder Zechariah? He may have been the Zechariah mentioned in II Chron. 24:20-21 (the priest Jehoiada may also have been known as Barachiah).
610. Did Jesus indicate in v. 37 that He had often tried to get the people in Jerusalem to accept Him, even though such attempts are perhaps not recorded?

(10)—Mark 12:41-44; Lk. 21:1-4

Mark

v. 41 *opposite*—where He could see it. See Matt. 27:61, where the women watched the burial of Jesus.

treasury (Greek gazophylakion, from gaza 'a treasure' and phylassō 'to guard'). Probably located in the court of the women.

FINAL WEEK

- v. 44 It was not that she had to give her all, it was that her heart was right.

Luke

- v. 1 The rich were not really giving, and just putting in money to be seen of men in some cases. It was not wrong to be rich—it was wrong to be rich and stingy.
- v. 3 She put in a tremendous amount in comparison to what she had to give—that is the type giving which God wants of us.

QUESTIONS

611. How much did the woman give in monetary sum (see the section of exposition for relative coin values)?
612. How much should we give to give as God wants us to—or is He rather concerned with our attitude about giving?

(11)—John 12:20-50

John

- v. 20 *Greeks*—probably proselytes, though maybe just interested. Perhaps the group in Acts 6:9 was formed by such people as these.
- v. 21 *sir* (Greek *kurios*, sometimes translated as 'lord').
- v. 23 We can not tell whether Jesus ever granted the Greeks an interview or not. His response to the action of Philip and Andrew seems so unrelated to the request. Perhaps if the situation were better known to us, we might understand why Jesus responded as He did.
- hour*—John's Gospel often presents this word in relationship to the ministry of Jesus.
- v. 24 *fruit*—the product of a sacrificial life. It is not

necessarily restricted to what we commonly know as evangelism though that is one way to bear fruit. See Matt. 21:43.

- v. 25 *he who loves* (Greek *ho philōn*, a constant affection for oneself is meant).

he who hates (Greek *ho misōn*, a constant rejection of self is meant). See Lk. 14:26ff.

- v. 26 The way one must "love" and "hate"—put the will of Jesus first at all times, and the demand is accomplished.

serves (Greek *diakonei*, as in *minister*, etc.).

follow (Greek *akoulouthēō*, a life-time habit is meant). God will recognize and reward faithfulness until the point of death, Rev. 2:10b. The disciple who habitually follows Jesus has eternal life, Jn. 3:36.

follow me—Jesus gave the example of what God's will demands. He will not lead us where we can not go. We will be able to follow where He leads, knowing He will be with us every step of the way.

- v. 27 As mentioned in the exposition, this verse is difficult to understand. We think R.S.V. has the best translation of the text, though other ways of translating it are possible.

this purpose: to glorify God, which required a death to self-will, as He had taught in v. 24-26. The cross was God's will, and the means of glorification.

- v. 28 Perhaps God meant that He had brought glory to His name (which stood for Himself) through the life of Jesus, and would continue to do so through that life.

- v. 29 The crowd did not understand what was said apparently, though hearing the sound of the speaking.

FINAL WEEK

- v. 31 *judgment* (Greek *krisis*, 'judgment', or 'discernment'). Jesus did not mean an opinion expressed, but something more definite. See ch. 15:18-25.
- v. 32 *lifted up*—Jesus meant His crucifixion; so in ch. 3:14.
- v. 34 They had understood Jesus to claim to be the Messiah (Christ). They also had a false concept of the nature of the Messiah. See Lk. 24:25-26. So they ask about the connection between the Messiah and Son of man, which title Jesus applied to Himself.
- v. 36 Jesus did not explain the situation so much as He did encourage them to keep on believing in Him, and wait for some things then unclear to become understood later. See v. 16.
- v. 37 Some among them did not believe on Him. Ch. 12:42-43, some were persuaded but had not sufficiently matured in faith to allow it to control them.
- v. 38 Isa. 53:1; Rom. 10:16-21.
- v. 39 They could not believe because they had not yet died as a grain of wheat, and God's Word thus was not in them, Lk. 5:39-47.
- v. 41 God has predestined certain effects related to certain causes. One is from unbelief, which brings about a hard heart and blind eyes. Thus, indirectly God had caused their state. Directly, they had refused to believe, and were reaping the results of unbelief. God's Word must meet with faith in the human mind or it can not bear fruit, Heb. 4:2.
- Isaiab*: a real person, and author of at least a part of the section which some scholars say he did not write (chs. 40-66).
- v. 43 *praise* (Greek *doxa*, elsewhere as 'glory').
- v. 44 The same message as elsewhere: one can not have

God the Father except through God the Son, as in 13:20; Lk. 10:16; I Jn. 2:22-23.

- v. 48 The objective body of truth against which all men are judged is Jesus' expressed teaching, either through Him personally or those who wrote at His direction, ch. 16:7-14.
- v. 50 Jesus will reveal in 17:3 that the commandment of God is directly related to Christ personally, in that God wills that all men accept His Son. This is how God's command is eternal life.

QUESTIONS

613. Do you think Jesus might have felt the Greeks who sought Him were unwilling to listen to what He had to say, which triggered the response in vv. 24-26?
614. Human nature being what it is, which would people rather do: lead or follow?
615. Was God pleased with Jesus' life on earth? How do you know?
616. Does following Jesus always mean we will perfectly understand everywhere He takes us?
617. Did the authorities in v. 12 love God with all their heart, mind and soul?
618. Why is it that Jesus constantly impressed upon His auditors the inseparable connection between the man, the message and the person sending the man and message?

(12) and (13)—Matt. 24:1—25:46; Mark
13:1-37; Luke 21:5-38

The reader may, if a harmony is being made, wish to divide this long discourse into smaller sections. If so, we suggest that the outline given in the exposition section be used to do so, following the break-down of texts suggested there.

FINAL WEEK

We will discuss ch. 24 of Matthew, with the parallel texts in Mark and Luke, then Matthew 25:1-46, which has no parallel, that the textual remarks may be kept together a bit better. However, the chapter division between 24:51 and 25:1 is strictly arbitrary, as Matthew did not write his book in chapters, nor did Jesus speak that way (or in verses either, for that matter). The chapter and verse divisions are man-made inventions.

Matt.

v. 1 Herod the Great had started work on it 19 B.C., and the work had been going on for some 50 years. It was cherished by the Jewish nation of course. The beautiful stonework was probably the topic of many conversations. This remark brought a rather unexpected discourse however.

v. 2 The Roman army did just what Jesus predicted: leveled the whole area.

v. 3 After the abrupt remarks by Christ, they walked across the Kidron valley and up the side of Olivet. Sitting down where they could view the whole area, Mark tells us that Peter, Andrew, James and John ask Jesus to clarify what He meant.

tell us: they again betray their ignorance of the nature of the kingdom and its relationships to the Jewish economy by their questions. They assumed that the destruction of the temple and consequently the Jewish way of life was equal to the end of the world and all involved therein. As the outline shows, Jesus sorted out their questions and answered each one, showing that the end of the Jewish economy and the end of the world were not equal at all.

v. 4 Jesus began to speak about the end of Jerusalem and the Jewish way of life, and the sign of that end: the Roman army surrounding the city. Thus the

NEW TESTAMENT HISTORY: THE CHRIST

- sign and the end were the same. Later He will show that His second coming is the sign of the end of the world, in much the same way as the Roman army heralded the end of Jerusalem.
- v. 5 The disciples would know better, but they would need to warn others about false pretenders.
- v. 6 The years prior to A.D. 66-70 did see many outbreaks in various places, as the Jews were in foment to break Roman rule.
- v. 7 The intervening 40 odd years would be filled with problems. Acts 11 remarks about a famine.
- v. 9 Many would be persecuted and killed in the first four decades of the church life, including James who was listening.
- v. 10 Paul wrote that Demas forsook him; that Hymenaeus and Alexander shipwrecked their faith, taking along others with them, just to mention a few.
- v. 11 The apostles all warned of true and false prophets, as in Acts 20:29-30; II Pet. 2:1; etc.
- v. 12 Paul encouraged Timothy to "stir up" the gift of God which he had, I Tim. 4:1; and warned that men would love many things other than God, II Tim. 3:1ff.
- v. 13 Unbelief is damning if persisted in.
- v. 14 And so it was, Col. 1:6; 23. Paul wrote the epistle from Rome, the hub of the whole empire and the center for access to such information (He could have known it by inspiration, for that matter).
- v. 15 Daniel 9:27; 12:11. The parallel in Luke specifies that the abomination of desolation was an army. Since the army was the Roman army, Gentile in nature, the entrance into the temple proper to destroy it would be an abomination to the Jews.
- v. 16 The Christians heeded Jesus' warning, and moved

FINAL WEEK

over into the Decapolis area, escaping the horrors of the seige.

- v. 18 The instructions were: don't get caught with your goods as your first concern. Get out when you can!
- v. 19 Obviously such conditions would hinder flight, as would the problems of v. 20, even for Christians.
- v. 21 Jesus had said in 23:35 that the blood of all the righteous from the foundations of the earth would come upon that generation. They were really in for it, as this verse indicates.
- v. 22 The Romans could have destroyed them all—Christians and non-Christians, but God took care of His people, the Christians.
- v. 23 As Jesus showed, He would not return until much later, and the disciples must not fail to heed His warning about escaping by listening to false rumors of His return.
- v. 24 It would take faith to remain true to Jesus' word.
- v. 25 He always tried to prepare His followers so that their faith would not be shaken. See Jn. 16:1-4.
- v. 27 There would be no need to say when Jesus came: everybody would know it.
- v. 28 When conditions are right, the events will happen. So: know the facts and be prepared.
- v. 29 *immediately*—probably to be understood in God's time scale, as the resurrection and second coming are parts of a whole. As Jesus pointed out, His second coming was to be anytime, thus the word "immediately" is quite in keeping with the "thief in the night" description of the second coming.
- v. 30 *sign*: is Christ Himself, signaling the ceasation of earthly affairs as v. 29 obviously described.
- v. 31 Even as the kingdom's end is pictured in Matt. 13:36-43.
- v. 32 As the fig tree heralds the nearness (or actuality of

- the coming of summer), so would Jesus' coming herald the end of the world. No doubt will exist when He comes, or what will happen when He comes, II Thess. 1:6-10.
- v. 34 *he*—Luke's account has kingdom of God. The person of Christ as the king is synonymous with the kingdom. Jesus may well have said kingdom, since the Greek could be translated "it" quite as well as "he."
- v. 34 The facial expressions and gestures of Jesus may have made these expressions much more understandable to His auditors than they are to us. We understand this verse to refer to the things (destruction of Jerusalem) just spoken of, and v. 36 to introduce the end of time and His second coming. Hence the contrast is between "these" things soon to pass, and "that" time, His second coming and the end of the world, further removed in time.
- v. 35 The disciples needed to be impressed with His statements as to their truthfulness. Many would surely question their position later when they attempted to persuade other Jewish Christians that the destruction of the city and the Jewish economy were not equal to the second coming and the end of the world.
- v. 36 Since Jesus while on earth only spoke as God directed Him, God had not directed Him to "know" or to speak about His second coming. Had Jesus said otherwise than He did, men would have searched His words minutely to decipher just when that time was. As it is, the only facts are: 1) He is returning, and 2) we know not when.
- v. 37 *days of Noab*—an historical fact, contrary to some scholars.
- v. 38 Jesus depicted the normal course of life in Noah's

FINAL WEEK

day: no one (but Noah and his family) was getting ready for a flood. So it will be in the days before Jesus' coming: few will be preparing. Jesus pointed out this great contrast in Matt. 7:13-14.

- v. 40 The idea of the unknown is the point: if the men had known, both would have been ready, doubtless. So with the women in v. 41.
- v. 41 *watch* (Greek *grēgoreite*, 'keep on watching', See 25:13). The disciple must be ready anytime, as v. 43-44 point out clearly.
- v. 44 Obviously, if any inkling was given as to His second coming, men would wait until the last minute to get ready. In the very nature of the case, Jesus could not leave even a faint indication as to when the return would be.
- v. 45 Hence, the teaching here and into ch. 25: be ever ready!
- v. 51 Note: the unprepared and the hypocrites receive the same punishment. Obviously, the hypocrite is unprepared, and all are disobedient, since the command is to be faithful and be ready.

Mark

- v. 1 The one disciple (perhaps Peter?) is singled out in respect to the remark about the stones. They all may have generally been speaking about them.
- v. 6 The Greek expression could be translated "I am" as in Jn. 8:58.
- v. 7 *wars and rumors of wars*: contrary to most commentators, radio and T.V. speakers, these are not to be a cause for alarm at all!

Repeat: no sign at all! And for two reasons: 1) the remark applied only to the end of the city of Jerusalem, and 2) something that happened all the time could hardly be a sign anytime.

NEW TESTAMENT HISTORY: THE CHRIST

- v. 11 God would take care of them, if they kept on believing. Actually, a faithful Christian, determined to remain so, need not fear anytime, even as Jesus commanded in Lk. 12:4-12.
- v. 12 See Lk. 12:51-53.
- v. 14 *mountains*—across the Jordan into the highlands on the eastern side, or south to other places of safety.
- v. 16 *mantle* (Greek himation) the most important piece of clothing—it was urgent that they leave. See Matt. 5:40 “cloak.”
- v. 27 The whole earth will know when Jesus comes, as Rev. 1:7 indicates.
- v. 33 *take heed* (Greek blepete ‘keep on looking’).
watch (Greek agrupneō, ‘to keep awake’ or ‘alert’ as in Eph. 6:18; Heb. 13:17).
- v. 34 The reason for total commitment: each disciple had his own responsibility, and no one could rest on the other’s laurels, as the parable in 25:14ff. pointed out.
- v. 35 The time is totally beyond guessing—all the disciple can do is be ready.
- v. 37 *to all: watch.*

Luke

- v. 3 noble stones and offering—much work and money had gone into the whole temple complex.
- v. 8 Jesus had warned about false teachers in Matt. 7:15-20.
- v. 13 Faith could really use the otherwise frightening time as an opportunity to witness for Jesus.
- v. 14 *settle* (Greek thete, from tithēmi)—“put it down and be ready!”
- v. 17 The disciple was to rejoice when such occasions arose, Matt. 5:10-12.
- v. 22 As Jesus predicted in Matt. 23:35.

FINAL WEEK

- v. 24 *times of the Gentiles*—may be understood several ways, perhaps referring to the Romans as the Gentiles. When the empire fell, the city would then begin to be rebuilt, and the Jews to return. It may well mean that since God had included the whole earth in the plan of the ages, that the city would really never be as it then was again.
- v. 27 Even as the men saw Him go, Acts 1:9-11.
- v. 28 *redemption*—the word on the lips of Anna, 2:37, and in essence on the lips of Mary and Zechariah, ch. 1.
- v. 34 One who is enrolled in the service does not entangle himself in civilian pursuits, II Tim. 2:4; neither does “good soil” clutter itself up with such things, Lk. 8:14-15.
- v. 36 *praying*—we need God’s help, and its ours for the asking, James 1:3-8, and we do so joyfully, knowing that He is able, Jude, vv. 24-25.

QUESTIONS

619. Review the questions of the disciples. Did Jesus’ answer each question?
620. What was the mistaken assumption in the minds of the disciples, so common in their thinking, which caused their questions to be muddled?
621. Why did God allow the city of Jerusalem and the temple to be destroyed, thus ending in a forceful way the Jewish economy?
622. What were the disciples to do when the end of Jerusalem began to draw near?
623. What kind of a sign were “wars and rumors of wars?”
624. How earth-shaking will the return of Jesus be?

NEW TESTAMENT HISTORY: THE CHRIST

625. Why did Jesus not mention any signs in the connection with His second coming?
626. What state of affairs is the disciple to keep his life in (or out of)?
627. List the various illustrations Jesus gave about the state of the world and the state of the faithful disciples at the second coming (remember that 25:1-30 is in the same sermon, and the illustrations there).

Matthew 25:1-46

Matt.

- v. 1 *ten*—probably no special significance to this number, or the fact that five were wise and five foolish. The point is: some were prepared, some were not, though they could have been.
- v. 5 A subtle remainder that one does not know the future, therefore preparation for the unexpected is imperative. See 24:48-51.
- v. 8 Their lamps were about out of oil, and the amount left was not sufficient to do what was expected. (The King James version has the lamps out, but the Greek text indicates they were still burning.)
- v. 9 The wise were so in more ways than one.
- v. 12 They were refused because they were not ready when he wanted them ready. As the following parable pointed out, good stewardship involved planning, which they did not do.
- v. 14 *servants* (Greek *doulos*)—all had something of the Master, plus the commodity of time.
- v. 18 Not only was he lazy, he was indifferent—both are damning in one's relationship to God. Faithfulness demands diligent use of time and talent both.
- v. 23 Each of the first two received commendation and something more to do.
- v. 24 *hard* (Greek *sklēros*, as in Matt. 19:8; Jn. 6:60;

FINAL WEEK

Acts 26:14; Rom. 2:5; 9:18; Heb. 3:8; 13, 15; 4:7; James 3:4; Jude 15). If he knew such, all the more reason to be condemned, as Jesus showed.

- v. 26 *wicked* (Greek *ponēros*)—he was really evil, like those in Matt. 12:39; Gal. 1:4; Heb. 3:12; James 4:16.
- v. 27 His indifference to his master was reflected in the poor use of the talent. He did not do his “work,” Mk. 13:34.

interest (Greek *tokōi*, from *tiktō* ‘to bear’ or ‘to bring forth’. Hence, a product or result).

banker—the ones who changed money, or dealt in lending. The Greek word (*trapezitēs*) denotes one who sits at a table, such as in Jn. 2:15.

- v. 29 Doing nothing is not an excuse, it’s a reason for condemnation.
- v. 30 *worthless* (Greek *achreion*, from *chreia* ‘use’ or ‘worth’ and a ‘not’, hence not of any use). The constant minor refrain in all of Jesus’ teaching: punishment or reward, depending on stewardship. The following illustration of the final judgment intensifies this theme.

- v. 31 *when*—unknown, but certain

Son of man—almost always from the lips of Jesus. The term describes the One Who came to be man, that He might show how to live, and make humanity understood that He understands, having lived in the flesh.

- v. 32 The separation is individually, but every person will be there, from whatever nation.
- v. 33 The division showed that each person’s character was known to the Son of Man.
- v. 34 *kingdom prepared*—Sometimes the kingdom is presented with the idea of nearness, as in John’s preach-

ing, but at other times it is presented as yet to come. The idea of eternal life is much the same, sometimes treated as if one possesses it now, but at other times as if it were something yet to be possessed. In truth, both aspects are correct—the Christian now is in the kingdom, but yet has more to be received from God.

- v. 40 As Jesus showed, service to one of His is service to Him. Thus we are encouraged to remember we are part of a body, I Cor. 12:12ff., and of the household of faith, Gal. 6:9-10.

my brethren—defines the word “these,” being in apposition to it.

- v. 41 The place called hell was not meant for anyone but the devil and his angels (II Pet. 3:9); but by choice one can receive punishment never intended, but deserved if one refuses to accept Christ.
- v. 45 Interestingly enough, the judgment day scenes are almost invariably based on what one does in life, not only in this whole section from 24:37 on, but in Rom. 14:12; II Cor. 5:10; Rev. 20:11-15; etc. Faith is never mentioned, but works are.
- v. 46 The punishment is co-equal with the reward, not only in length of time, but in duration of it. Personality is not extinguished (annihilated) in heaven any more than it is in hell.

QUESTIONS

628. What is the point of the parable of the ten virgins in relationship to Jesus' discussion of His second coming?
629. When He comes again, will everyone be required to render an accounting of “his work,” Matt. 13:34?

FINAL WEEK

630. Did the closing judgment day scene outline how a person might "work" while in this life?
631. Can obedience and faith (as God views faith) be separated? (Cf. Rom. 1:5; 16:26.)
632. Who are the "least of these?"
633. For whom was hellfire originally meant?
634. How long is the reward and punishment for? Do you suppose that those who object to eternal suffering in hell for the unfaithful really do not understand how much sin cost God, or how terrible it really is? (Perhaps if we could realize the nature of sin as God does, we might think being punished eternally in hell was hardly good enough for sinners!?!)

(14)—Matt. 26:1-5, 14-16; Mk. 14:1-2, 10-11;
Lk. 22:1-6

Matt.

- v. 2 *after two days*—We assume then that the day the preceding events occurred was Tuesday, and that the agreement by Judas with the chief priests probably took place on Wednesday.
- crucified*—The disciples knew the meaning of the word, but seemingly did not comprehend that it could happen to Jesus.
- v. 3 *Caiaphas*—sometimes the Gospels say chief priests, as in Matt. 21:23 or 27:12, since Annas, father-in-law of Caiaphas was the high priest appointed according to the Jewish law. Caiaphas was appointed by the Romans. The reason why the Romans kept their hand in the game was because the position of chief priest was one of tremendous influence.
- v. 4 *stealth* (Greek *dolos*, as in Mk. 7:22; Jn. 1:47; Rom. 3:13; II Cor. 4:2; 11:13).
- v. 5 So they planned to kill Him after it was over, and

NEW TESTAMENT HISTORY: THE CHRIST

the people who were believers in Christ would be gone. They got the same thing accomplished by catching Jesus at night, and having Him on the cross early in the morning before any of His supporters in number were aware of it.

v. 14 As the preceding verses (6-13) indicate, Judas was probably provoked by the loss of the ointment, and was then motivated to recoup his loss in this way.

v. 15 deliver (paradidōmi, 'to betray' or 'hand over'). The Jewish hierarchy received an unexpected assist in their devilish planning.

thirty—the actual amount is known, but its worth is not stated. It was doubtless worth a large amount, but exactly how much is unknown.

v. 16 Since Jesus knew this years earlier, He took extra precaution to make sure the place of the last supper was not known by Judas until they arrived there. Thus, Judas could not betray Jesus until he left, Jn. 13:30. Jesus and the rest of the apostles then also left before Judas could get the men and go back to the place of the supper. Hence, they find Jesus in the garden, where the provision for the flight of the other disciples was made easier, plus the fact that no other people who might have been friends of Jesus could get involved (as might have been the case if the large group of arresting officers had come to the house).

Mark

v. 1 The Passover was only a one day feast, but the Feast of Unleavened bread involved it, plus another week. The word Passover then came to encompass the whole feast, and vice versa, as Luke's account shows.

v. 2 *tumult* (Greek *thorubos*, as in Matt. 9:23; 27:24; Mk. 5:38; Acts 17:5; 20:1, 10; 24:18).

FINAL WEEK

- v. 11 *glad* (Greek *chairō*, 'to rejoice' or 'to be happy').
opportunity (Greek *eukairos*, a 'good time' or 'pleasing time') as Luke points out, in the absence of the multitude, which was "pro-Jesus."

Luke

- v. 2 *feared*—they did not want to cause an uprising, which might possibly bring the wrath of Rome down on their heads. See Jn. 11:47-50.
- v. 3 The betrayal by Judas was nothing less than Satan's suggestion acted upon by Judas. John will remark again at the supper the following night that when Judas left the room to get the men for the arrest, that Satan again entered into Judas, 13:27.
- v. 4 *captains*—probably temple police, and under the jurisdiction of the priests.

QUESTIONS

635. Why do you think Judas betrayed Jesus?
636. If the multitude was mostly for Jesus, why were the Jewish rulers not for Him?
637. When did Judas make the agreement with the officials?
638. The chief priests were glad when Judas came to offer his help—if Jesus knew Judas was going to do that, why did He choose Judas?

(15)—Matt. 26:17-19; Mark 14:12-16;
Lk. 22:7-13

Matt.

- v. 17 The first day this particular year would be Thursday—it was the day when the house was to be cleared of anything with leaven in it.
to prepare—the lamb would have to be obtained, plus the bitter herbs and unleavened bread. The

place where the feast was to be held was also to be secured.

- v. 18 Jesus made sure that none of His disciples knew where the place except Peter and John (Luke v. 8). *at your house*—this is some indication that Jesus may have already made arrangements with this person (see Mk. v. 14-15). Some suggest that it might have been the house of John Mark's mother, which was later a meeting place for the disciples, Acts 12:12. Mark, v. 17, reads a bit as if it were written by John Mark, as he remembered their coming.

Mark

- v. 12 The lamb would be sacrificed (after being approved by the priests) by being cooked whole. It was to be consumed entirely by morning, or else the remainder was to be burnt up.
- v. 13 A man would rarely carry a waterpot, so this one would be easier to find than might otherwise have been the case.
- v. 15 Just where this room was is not possible to determine, remember—the city was leveled by the Romans some 40 years later.
- v. 16 *as He told them*—one would think such obvious foreknowledge and the implications thereof would register on the disciples, but it did not, apparently.

Luke

- v. 7 The priests began killing the lambs by early afternoon. Some suggest that the number of Jews at the feast would be two million or more. The traditional limits were 10 people minimum and 20 maximum for each lamb. Hence, some 200,000 lambs might have been required for the feast. The temple officials kept flocks all year round to provide such tremendous amounts (the shepherds to whom

FINAL WEEK

the angels appeared in Lk. 2 may have been temple shepherds).

QUESTIONS

639. What two terms were used interchangeably, according to Luke?
640. Why be so secretive about where the upper room was?
641. What three things were required to observe the Passover, according to the Scripture?
642. Who was sent to prepare the Passover?

(16)—Matt. 26:20-29; Mk. 14:17-25;
Lk. 22:14-30; John 13:1—17:26

The reader will observe that we have a long section in John's Gospel, plus parallel passages in Matthew, Mark and Luke. In order to facilitate study, we will break the texts down into sections as indicated henceforth.

Luke 22:24-30

This section is after the supper begins in textual order, but Luke does not say when the incident occurred chronologically. We assume it may have occurred at or near the beginning of the supper, which may have prompted the action of Jesus in John 13:11ff.

Luke

- v. 24 The disciples were never persuaded that any of them was first among equals. The dogmas of the Roman Catholic church demanded that distinction, which is quite unscriptural. See on Matt. 18:1ff.
- v. 25 See Matt. 20:25ff.
- v. 26 *youngest*—that is, the inferior person. See Rom. 12:10b.

- v. 27 Jesus will soon show that, as He gets up to wash their feet.
- v. 28 They had their problems, but they were loyal to a great degree, probably more than we give them credit for being.
- v. 30 It would be grand beyond their dreams, and doubtless much different. The ruling they did may well have been through the preaching they did, which encompassed legislation for all.

QUESTIONS

643. If Peter had been designated as first among equals, why did the disciples keep arguing about who was greatest?
644. What attitude does a servant have?
645. Could a disciple be too insistent about being inferior, and attempting to serve others? (ie., can one be proud of humility, etc.?)
646. Did Jesus have to talk about rewards for service in terms the disciples would understand?

John 13:1-20

John

- v. 1 *before the feast*—this locates in time the fact that even before the Passover just beginning, Jesus loved His own (disciples). It does not have anything to do with when Jesus ate the Passover.
- v. 2 *during supper* (Greek *deipnou ginomenou*, 'the supper having come to be', i.e., while the meal was in progress).

the devil—it is the devil's to suggest, it is our option to accept. Judas accepted, and had already made the agreement to betray Jesus to the Jewish rulers.

FINAL WEEK

- v. 3 *Jesus, knowing*—this also was true before the feast began.
- that he had come*—this indicates Jesus knew His origin.
- v. 4 *rose from supper*—John has stated five facts that are to be located in time prior to the meal:
- Jesus loved His disciples
 - Jesus knew that the “hour” He had been prophesying of had arrived
 - Judas had already decided to betray Christ
 - Jesus knew of the authority He had from God
 - Jesus was fully aware of His origin and destiny
- laid aside his garments*—the outer robe, and outer garments that would hinder the washing of feet.
- v. 5 Jesus had just admonished them for quarreling about who was the greatest and told them that He was among them as one who served, Lk. 22:24-30. Here He showed that such was so.
- v. 6 We know not if Peter was the first, or simply waited until Christ came to him.
- v. 7 Sometimes the disciple must accept things from the Lord, without questioning why the Lord does them.
- v. 8 *never* (Greek *ou mē*, not by any means!).
- v. 9 Peter is still giving orders, hardly appropriate of a follower.
- v. 10 The word “clean” seemingly has two applications in this verse, one to bodily cleanliness, the other to cleanliness from sin. 15:3 indicates that God’s Word had cleansed the men, at least all but Judas Iscariot, who had rejected it.
- v. 12 *Do you know*—that is, understand? He explained it in v. 14-15.
- v. 16 God serves all in countless ways, both in small and great ways—can the follower of God do less?

- v. 18 Psalms 41:9. We wonder if Judas caught this remark.
- v. 19 *may believe*—not lose faith in Christ. They were shaken for awhile, but all decided for Christ finally.

QUESTIONS

647. What things did John mention as being true before and up until the Passover meal?
648. Why did Jesus wash the disciple's feet?
649. How did serving the men in such a way degrade Jesus? or did it?
650. Is it always easy to follow, or is it beneath our dignity sometimes?
651. Asking it a different way, is being gracious while being served hard for us sometimes?

Matt. 26:20-25; Mk. 14:17-21; Lk. 22:14-18,
21-23; Jn. 13:21-30

Matt.

- v. 20 *sat*—reclined on a pallet, resting on one side.
- v. 21 The prediction of Jesus and the responses of the disciples took place while the meal was in progress.
- v. 22 They expected a "no" answer.
- v. 23 But the significance of this statement may have been lost on the men: they may not all have heard it; or they may have heard it but did not believe it, thinking that surely one of them would not be guilty. However, from a different standpoint, all the disciples may have thought that they were sharing the dish with Jesus, at least in some fashion (see Mk. v. 20). It is evident that they did not understand what Judas was up to, whether the expressions of Jesus were heard or not.
- v. 24 See the knowledge of prophetic utterance concern-

FINAL WEEK

ing the suffering and death of the Messiah in this remark. But the disciples did not 'hear' what Jesus had been saying or was then saying.

- v. 25 Though Judas framed his question to expect a "no" answer, Jesus replies affirmatively.

Mark

- v. 17 The verse seems to imply the recollection of an eyewitness who had watched the men come to the house.
- v. 21 Judas did not repent of his sin, but rather took his life, indicating an unrepentant state of mind.

Luke

- v. 14 It would be after sunset on our Thursday, which would begin their Friday.
- v. 15 He had felt this way for several reasons, one of which was His love for them. Another was the realization that it would signal the end of one era and the beginning of another.
- v. 16 The Passover feast pointed to a real sacrifice for sin, which sacrifice was Jesus. The church (kingdom) would begin with the proclamation that through the death of Christ the sins of all men could be forgiven.
- v. 17 This cup was apparently not the same one with which He remarked that it represented His blood. The textual variant in v. 20, the parallel passages in Matthew and Mark, plus the account in I Cor. 11 seem to show that the cup representing His blood came after the supper was ended.

fruit of vine—none of the accounts say "wine."

The O.T. did not command any beverage whatsoever. Hence, the drink could be whatever one chose.

- v. 21 Jesus is still indefinite in some respects.
- v. 23 The discussion probably occupied the rest of the meal.

NEW TESTAMENT HISTORY: THE CHRIST

John's account shows that none of the disciples really understood whom Jesus meant.

John

- v. 21 *troubled* (Greek *tarassō*, as in Matt. 2:3; 14:26; Mk. 6:50; Lk. 1:12; 24:38; Jn. 11:33; 14:1, 27; Acts 15:24; 17:8; Gal. 1:7; 5:10; I Pet. 3:14).
- v. 23 John apparently was reclining immediately to the front of Jesus, a place of honor.
- v. 24 Peter was seemingly either unable to ask whom Jesus meant, or unwilling to ask. So he got John to ask Jesus directly.
- v. 26 Judas is close to Jesus we assume, perhaps reclining immediately behind Him. But the significance of this act may have been lost on all but John, since Jesus might have been serving the men around Him.
- v. 28 They did not make the connection between all Jesus had said before this and this statement.
- v. 30 When this occurred in relationship to the institution of the Lord's Supper is not specifically said.

it was night—men for centuries have wondered why John wrote this. Of course it was night—the feast was to take place at night. So this remark was at least superfluous. Hence the suggestion is quite possible that John meant that the darkness of the world outside was hardly greater than that in the life of Judas. See Matt. 6:22-23.

QUESTIONS

- 652. When did the feast begin?
- 653. Make a diagram of the table, using a horseshoe shape as a pattern, with the open end to the right. Perhaps Peter would be on the outside of the table at one end, John immediately across the table at the other end, immediately to the left of John Jesus,

FINAL WEEK

and to Jesus' left Judas. Maybe this could have been the way the men were around the table.

654. Why would it have been better for the man who betrayed Jesus not to have been born—how would Jesus have been betrayed so that He could die for us?
655. What kind of drink did Jesus say they had? Did the O.T. require it?
656. Why did the disciples not understand that Judas, the son of Simon Iscariot, was the betrayer?

Matt. 26:26-29; Mk. 14:25; Lk. 22:19-20

Matt.

- v. 26 The meal was replete with enigmas—first the foot-washing, then the statement about betrayal, now the use of a piece of unleavened bread, and Jesus' remark about it representing Him—how could that be?

take—each was commanded to take it.

eat—and each was commanded to eat of it.

What could this mean?

- v. 27 *took a cup*—I Cor. 11 indicates the cup was passed around at the close of the meal. How long before the cup the breaking and eating of the loaf occurred is not said.

given thanks—for the loaf, now for the cup.

Jesus taught the art of being appreciative.

all of you—each one was to partake of the cup, not all of it, but from it. Whether Jesus passed it around, or poured them all some from it is not stated.

- v. 28 *this is my blood*—the disciples knew it was not really His blood, but must in some way represent it, just as was true of the loaf and His body.

NEW TESTAMENT HISTORY: THE CHRIST

- v. 29 He would do so in the communion services they would begin to observe in His memory. The communion service is at once a memorial, a proclamation, a fellowship and a covenant. We do not come together because we are perfect, needing nothing, but to remember Jesus Who was perfect, but Who died that we might need nothing.

Mark

- v. 24 Nothing is said about the communion service being the "center" of any worship service (what importance does the preaching of the message of redemption have?), nor that any sins are forgiven anyone for partaking. It might be a good time for self-examination and repentance, but Jesus does not indicate that is the reason for it at all.

for many—the service is not to remember what the world did to Jesus, but what Jesus did for the world.

Luke

- v. 19 *broke it*—perhaps giving each of them a piece, or passing around the piece He had broken off, so that each of them could share from it.
- v. 20 This verse is omitted by R.S.V. on rather good textual evidence, but the same truth is contained in other passages.

QUESTIONS

657. What does the communion service represent?
658. Does it do any good to just mechanically go through the motions of partaking? any evil?
659. What is the meaning of an "unused" cup?
660. When Paul spoke of partaking in a manner that is unworthy, did he mean failure to be conscious of our need? failure to rightly appreciate it?

FINAL WEEK

John 13:31-38

John

- v. 31 We note that glory can come to God through even death.
- v. 33 See John 20:17. Perhaps Jesus felt that to explain all the details of where He was and why they could not come would be useless. Peter voiced his feeling that he could go anywhere with Jesus, even to death, v. 37, which showed that he did not understand.
- v. 34 The newness was in the degree of love, not in loving itself, which was the basis of the O.T. law, Lk. 10:25-28.
- v. 35 The example of Jesus relived in the lives of His disciples would arrest the attention of others, and display the common bond between those disciples.
- v. 36 The ideas of death, resurrection and ascension had not really registered with the disciples.
- you shall follow*—this seems to be a prophetic statement concerning Peter, at death, going to heaven.
- v. 38 Jesus did not deny that Peter would be willing to give his life, just that he would soon lack the courage to even speak for Jesus. As the incident in the garden showed, Peter was willing to fight for Jesus. Christ could foresee, however, that at a time soon to come Peter would deny any relationship to Him. But see Lk. 22:31ff.

QUESTIONS

661. Name a number of ways God could be glorified.
662. Did Jesus try to prepare the disciples for His departure?
663. In what way could the command to love be new? It was the basis of the law and the prophets, Matt. 22:35-40.

664. Did Peter's denials of Jesus mean that Peter would not lay down his life for Christ?
665. Could the separation of Jesus from the disciples provide an opportunity for growth rather than a cause of sorrow?

John 14:1-31

John

- v. 1 *Let not*—they had plenty of reason to be upset, at least within themselves. The arguments over greatness, the footwashing, the accusal of betrayal—all would tend to bring troubled feelings.
- v. 2 Even with Peter in 13:36, Jesus tried to reassure them that He had made adequate preparation for them. Since they should have known His ability by that time, they should have been at ease.
- v. 6 In answer to Thomas, Jesus replied that the place and the means to get there were wrapped up in a person in Whom was no deviation from the true, and Who had life in Himself, for which everyone sought.
- v. 7 Jesus anticipated their unspoken thoughts about God Who they assumed was at the end of the way.
- v. 8 Whether Philip meant that to see God would allay any fears they had, or was all they wanted is difficult to decide.
- v. 9 Somewhat of a rebuke—the miracles done by Jesus, the teaching about Himself, the acceptance of worship: all should have pointed up the fact that He was deity, as He mentioned, v. 11.
- v. 10 See a like expression in ch. 12:44-50.
- v. 11 *Believe*—the Greek indicates that He was from God. *for the sake*—an argument of cause and effect.
- v. 12 Trying to bolster up their sagging spirit. He chides

FINAL WEEK

them in v. 28 and in ch. 16:5-6 for feeling sorry for themselves, and not rejoicing in His good fortune.

- v. 13 *in my name*—by His authority, or through Him. The first time Christ has mentioned asking of God by Christ's authority. See 15:16; 16:23, 24, 26. However, reread Matt. 18:19-20.
- v. 14 The verse is plain: don't be afraid to ask. However, the total Bible context must be taken into consideration, such as I Jn. 5:14-15.
- v. 15 The emphasis is on cause and effect: if love for the Lord exists in one's life the desire to observe all the Lord asks will be the consuming passion in that life. See v. 21 for the same thought.
- v. 17 Though this promise was given to the apostles, in actuality the same Spirit of truth is given to every Christian.

dwells—in the person of Christ.

in you—the Greek text could be understood as "among" or in the total group of disciples rather than in them each personally, though the latter can also be true. See Jn. 6:56 and try to decide if the disciple abides in Christ in the same way at the same time as Christ abides in the disciple.

- v. 18 *desolate* (Greek orphanos, as in James 1:27). Alone, Jesus means. So He kept reaffirming His presence in their lives, as in v. 23.
- v. 20 Note "My Father"—yet Jesus did not say that He and His Father were one and the same, anymore than the disciple and Jesus were one and the same.
- v. 21 *loved by my Father*—the same inseparable connection He has always taught, that what one does with the Son is what is done with the Father.

having (ho echōn), *keeping* (ho terōn), *loving* (ho

NEW TESTAMENT HISTORY: THE CHRIST

agapōn): 3 parts of one whole (i.e., the disciple's life).

v. 22 *how*—Judas (probably known also as Thaddaeus, son of James) he wondered if it would be a secret manifestation, or perhaps in a different form, unknown to any but them.

v. 24 *he who does not love* (Greek *ho mē agapōn*, the one whose life is not habitually characterized by love, as in v. 15, 21).

v. 26 *in my name*—He kept trying to impress upon them that the going away was “good” for them, and that such “going away” did not mean He was forsaking them.

v. 27 *peace*—the difference was that Jesus' peace meant a right standing with God, which the world's peace did not.

troubled . . . afraid—the disciples were content while Jesus was personally there, and they were to maintain that state.

v. 28 *greater than I*—probably in ways related to Jesus' humanity, though He did not specifically say so. The disciples were to do greater works than He did, v. 12, but we wonder how that was possible. The fact is that we know neither for sure—we just have to accept the fact as stated and be content. Reread 13:16.

v. 30 *ruler*—Satan is said to be the “god of this world” and to have the “power of death,” II Cor. 4:4; Heb. 2:14. However, those expressions are relative to God, Who controls all. The passage in II Cor. may mean that no one makes Satan into a “god” except people of this world. The passage in Hebrews may be understood to say that as Satan has the privilege to tempt people, he has the power of death, since yielding to temptation is sin, and sin results in death.

FINAL WEEK

he has no power—so Satan was not the only ruler in the world. For that matter, v. 1 rather clearly states that the disciples had chosen God to receive their worship rather than Satan.

- v. 31 *rise*—whether this means the rest of the discourse in ch. 15 and 16 was spoken before they left the room, or perhaps even before they actually got up off the pallets, we know not. To pray as He did in ch. 17 while walking along the dark streets, or while standing around getting ready to go would seem a bit of improbable, but it might have been any of these ways suggested, or others not suggested.

QUESTIONS

666. Do you think the disciples believed both in God and Christ?
667. Did Jesus promise a "second coming" for His disciples?
668. Do you sympathize with the question of Thomas in v. 5?
669. Did Philip (v. 8) attempt to subtly remind Jesus that they had not seen God (as they would understand God)?
670. Did Jesus think that the disciples should have reasoned from what He said and did that they had seen God at work (ie., the cause and effect argument)?
671. If we ask in faith, does that mean we get anything we ask for? Suppose we should pray for one billion dollars . . . why not?
672. How long was the Spirit of Truth to be with the disciples?
673. What would that length of time imply about the nature of the Spirit of Truth: human or divine?
674. How do you think you dwell in Christ—the same

NEW TESTAMENT HISTORY: THE CHRIST

- way God and Christ and the Holy Spirit dwell in you? If not, why not? (Cf. Rom. 8:11; Col. 1:27.)
675. Could Jesus manifest His presence by a "still, small voice" or in a form unable to be seen except by those specially prepared to see?
676. Does obedience indicate fear or love?
677. Did Jesus say love would naturally result in obedience, or that obedience and love are two separate but related ideas (i.e., that the disciple loves God, and also obeys God)?
678. How many different things did Jesus say the Holy Spirit would do for the disciples in these chapters (14, 15, 16)?
679. How many different ways did Jesus describe the Holy Spirit in these chapters?
680. If Satan had no power over Jesus, how could Satan tempt Him?

(17)—John 15:1-27

- v. 1 *true*—as opposed to the shadow, as God is the true (alēthinos) God in opposition to any others (cf. I Cor. 8:4-6).
- vinedresser* (Greek gēorgos, as in I Cor. 3:9).
- v. 2 *bears* (Greek pherōn, a life time of bearing)
- prunes*—the only reason for pruning is more fruit. Oftentimes, pruning is a drastic process, especially with grape vines. They only bear on new wood, the old branches having been pruned away. Sometimes God may want to cut out of our life everything so that we can be fruitful. Read Luke 14:26ff. in this light, then Matt. 10:34ff.
- v. 3 The eleven men left listening had accepted Jesus' word as it was in truth, the Word of God, 17:6.
- v. 4 Connection by the branch (each individual disciple)

FINAL WEEK

is imperative, and must be continuous throughout life, v. 5.

- v. 5 Jesus attempted to clearly state the relationships of disciple to Master.

abides (ho menōn, the habitual life-time dweller in Christ) the Greek word is the same as in 14:2 (rooms/mansions) and 14:23 (home/abode).

- v. 6 Obviously teaches the disciple may, if so willed, choose to quit being a part of the vine. There is no point in talking about branches ceasing to be branches if they never were branches. The whole point is to become and remain a part of Christ, else the punishment of being an unfruitful branch will become a reality.

- v. 7 The point is: our choice to remain. The reception of Jesus' words and consequent obedience of them will allow each person to become and remain a branch (disciple). In this way, we give evidence that we are disciples.

- v. 8 *fruit*—see on Matt. 21:43.

- v. 10 One can not be loved by God as a disciple unless that disciple obeys as a habit in life. The immediately preceding verses have outlined the life's occupation of the disciple: being in Christ, allowing God to prune, and the result is fruit.

- v. 12 *as* (Greek kathōs) in the same way as in v. 9. Love may be expressed in various ways, as God did in the life of Jesus, which life was culminated on a cross. See also Heb. 12:6 and context surrounding the verse.

- v. 13 Explains how Jesus loved them—and us. But God's love was even greater, as in Rom. 5:8.

- v. 14 Friendship is conditioned on obedience. All disobedient people (as a life time habit) are not friends of Jesus.

- v. 15 Jesus tried to be plain and clear, though the disciples were far removed from understanding all He said. But He remarked in 17:8 that they were in some respects totally persuaded that He was what He claimed, and stated rather clearly in 17:25 that they knew some things about Him.
- v. 16 Their fruit would be in the multiplication of believers, and edification of those believers, as in 17:20ff.
- v. 17 This night, love has been conspicuous by its absence; the self-pitying of the disciples at the mention of Jesus' departure, the betrayal by Judas, the arguments . . . !
- v. 18 The disciple will share in more than Jesus' love—specifically the hatred of the world. They would definitely need a "comforter" or "helper" like God Himself to steady their feet, and buoy up their confidence in God's concern for their best welfare. Note here Matt. 24:12-13.
- v. 19 The clear line of demarcation is adherence to Jesus. Every moment of life will not be one of intense resistance from the world, but active Christianity will sooner or later get opposed.
- v.20 *remember* (Greek *mnēmoneuete*, 'keep on remembering').
- v. 21 Because the disciple and the Master are as inseparable as the vine and branch.
- know*—often the condemnation is that evil people are so because they did not know God. See ch. 8:55. The word "know" carried much more meaning than just "be aware of." It meant something like be of the same persuasion, outlook, and nature. See 14:17; 16:3; 17:3.
- v. 22 *no sin*—as they now had. See ch. 3:19 in this re-

FINAL WEEK

gard. Jesus had come, and His life was a test for all, v. 24, 16:9.

- v. 24 Point: the revelation of God in Christ makes people into lovers or haters, and the object of love and hatred is God, and His Son, Jesus Christ.
- v. 25 Ps. 69:4. Notice the inclusion of the Psalms under "law," and the reference to "they," i.e., the ones who hated Jesus.
- v. 26 The Counselor would continue to bear witness through the apostles and others to Christ, despite the rejection of Him by some, then and through the succeeding years.
- v. 27 *from the beginning*—the qualification of the replacement for Judas, Acts 1:21ff. The point in time is the ministry of John.

QUESTIONS

681. Does the vine bear fruit of itself, or on branches?
682. Does the branch have life in itself, or from the vine?
683. Is the individual disciple a branch, or was Jesus speaking of denominations, etc., being branches?
684. What is the definition of fruit—or did Jesus give one?
685. How were the disciples to glorify God?
686. The joy of Christ was to come through what means?
687. What is required to be classified as a friend of Christ?
688. Did Jesus imply in v. 16 that the fruit of the apostles would always be in existence?
689. Is every disciple of Christ to be persecuted? If so, are you a disciple? (Could we all of a sudden develop a "persecution complex?")
690. Did Jesus imply in v. 24 that the amount of opportunity in a person's life determines the amount of sin in that person's life? (See 16:9.)

691. Does the Bible indicate any witnessing done by the Holy Spirit except that done through men?

16:1-33

- v. 2 Saul of Tarsus did exactly what Jesus predicted, Acts 26:9ff.
- v. 4 *I was with you*—as remarked in 17:12, though He guarded them, they would yet need help when He left, which He will now promise in the person of the Holy Spirit.
- v. 7 *Counselor* (Greek *paraklētos*, a “helper,” “advocate,” “friend”).
- v. 8 *convince* (Greek *elenchō*, ‘to expose’ or ‘to set forth’, as in Matt. 18:15; Lk. 3:19; Jn. 3:20; 8:49; Eph. 5:11, 13; I Tim. 5:20; Titus 1:9, 13; 2:15; Heb. 12:5; Rev. 3:19). The Holy Spirit was to do somewhat the same work through the use of men as the prosecutor does in a court-trial: to cross-examine (the common use of *elenchō* in N.T. times) the witness or opponent.
- v. 9 Jesus’ life was a means of judgment, even though He came to save the world, not condemn it, Jn. 3:17.
- v. 10 *you will see me no more*—Jesus would be present in the lives of the men, Gal. 2:20.
- righteousness*—it comes by faith, Rom. 1:17, and brings life with it.
- v. 11 Satan and his kingdom were doomed, because Jesus had overcome, v. 33. The fact of judgment to come should help us set our primary goal in life.
- v. 12 The presentation of material for which the hearer is unprepared is impractical. Hence, the disciples needed some more time and understanding that comes through time. Jesus may have done much of this the days preceding His ascension, Acts 1:3.

FINAL WEEK

- v. 15 The N.T. is a marvelous example of what the Holy Spirit did, for each page presents Christ in some way. The Holy Spirit played "second fiddle" exceedingly well, for there is no systematic presentation of Himself or His Work, but there is much of Jesus and what He does in one's life.
- v. 19 Jesus will explain in the following verses what He meant, by the analogy of the woman in childbirth. The illustration would do two things: present the fact that for a short time they would be distressed, but soon the realization of what Jesus really was would come, and a new life for them would begin.
- v. 22 *no one*—because they would be assured of Jesus, and wholly committed to Him.
- v. 24 The new addition to the model prayers of Matt. 6 and Lk. 11: ask through Jesus' name (ie., by His authority, and in respect to Who He is).
- joy*—he used illustrations to help them understand, explaining the unknown by the known. Soon time and experience would so develop them that the unknown would become known.
- v. 27 *you have believed*—even though they faltered at times, Jesus foresaw their faith continuing, and built the future of the church on their faithfulness, 17:20ff.
- v. 30 They tried to state what they felt and believed. Jesus will show in vv. 31-32 that they were yet woefully weak. The resurrection would change that!
- v. 32 No man is ever alone when God is with Him, and that is all that really counts.
- v. 33 *peace*: a state of mind regardless of the circumstances. No man can deprive a disciple of the ability to think about circumstances as the disciple wishes to think. Hence, the disciple can be happy

regardless of life's problems. See Matt. 5:10-12; Rom. 8:28; Phil. 4:11, for example.

QUESTIONS

692. How does one really know what God's will is? Saul of Tarsus thought he did, but he did not.
693. Why was the presence of the Holy Spirit in the lives of the disciples an advantage over having Christ with them?
694. How much truth was the Holy Spirit to give to the disciples? What implications does that answer have for any later "revelation," etc., as others have claimed through the years?
695. How did the Holy Spirit glorify Christ?
696. The disciples were like a woman bearing a child—how?
697. Does receiving things asked for from God bring joy?
698. Why would Jesus not ask God in behalf of the disciples' needs?
699. Did the scattering of the disciples indicate absence of faith, or understanding?

Matt. 26:30-35; Mark 14:26-31; Luke 22:31-38

We stated in the section of exposition that these scriptures may be better placed somewhere else. They may fit right after 14:31, or after 17:26. John's Gospel does not mention these events, so it is difficult to say just where they go. We will treat them here, though the reader may wish to place them elsewhere.

Matt.

- v. 30 The fact that Judas had gone to inform the Jewish officials where Jesus was made it imperative that the men leave the upper room rather soon. So the

FINAL WEEK

disciples and Jesus did not remain the night in the room.

- v. 31 Somewhat parallel to Jn. 16:32. Zechariah 13:7 has this prophecy, though the context of Zechariah does not apply directly to Jesus.
- v. 32 The angels remind the women to tell the disciples about this promise in Mk. 16:7. The disciples did not catch the idea of "raised up."
- v. 33 *fall away* (Greek *skandalizō*)—sin in turning from Jesus.
- v. 34 The same general conversation had occurred earlier in Jn. 13:36-38.
- v. 35 *so said they all*—none of the remaining eleven were going to betray Jesus, they affirmed.

Mark

- v. 26 The moon would be full, and perhaps provide adequate light for the walk through the city and across the Kidron into Gethsemane.
- v. 31 *vehemently* (Greek *ekperissōs*, 'exceedingly' or 'with great force'. Only occurrence in N.T.

deny—equal to sinning.

all said—the Greek text implies that they all kept saying that they would not do such. They still remembered the statement of Jesus at the meal about betrayal.

Luke

- v. 31 This verse indicates Jesus' knowledge of the activity of Satan in the lives of people, and the intercession of Jesus for Peter especially. See Jn. 17:12 in this light.
- v. 32 *when you have turned*—Jesus knew Peter was going to fall, but He also knew Peter was going to get up, too. And so likewise with the other 10 men with

them. How much more prepared the men would be to understand the grace of God and the frailty of humanity after this experience.

- v. 35 The occasions were Matt. 10 and Luke 10.
 v. 37 The text is from Isa. 53:12. Jesus had prophesied of this time some 700 years earlier through His servant, Isaiah.
 v. 38 After the remark in v. 36, their reaction is perhaps understandable. Yet the command for Peter to put up his sword, and the remark in Matt. 26:52 certainly leaves one guessing.

It is enough—whether Jesus meant this in an ironical way, or with a sigh of discouragement over their misunderstanding we know not. Perhaps He really meant that two swords were enough for that time, since He later would not let Peter use even one of the two.

QUESTIONS

700. Did Jesus predict the disciples would both sin, and repent of it to serve Him?
 701. Did the fact that Jesus predicted the total apostasy of the men perhaps aid in their coming to repentance afterward?
 702. How many times was the rooster to crow before Peter's denials according to Matthew? Mark? Luke? John?

John 17:1-26

- v. 1 *glorify*—God answered that request by means of the cross. If we are unselfish in our life, men may see God through us as we let God live through us, Matt. 5:16, even as Jesus did, v. 4.
 v. 2 Though human, Jesus yet had the divine ability to

FINAL WEEK

give life to all who would come to Him, Jn. 10:10; 5:40.

- v. 3 The need for mission work, evangelization of the world, is found nowhere in a greater way than in this verse. If eternal life is to be had only by those who know God the Father through Jesus the Son, the greater part of the three billion people now living are under the wrath of God, Jn. 3:36.
- v. 4 Jesus clearly looked beyond Gethsemane, Calvary, and the empty tomb, seeing the victory of a completely dedicated life.
- v. 5 Jesus alone could have manifested the knowledge and made the claims in this verse. No other human could then (as now) assert what Jesus did in this verse. It spells out nothing less than the eternality of Jesus.
- I had* (Greek eichon, "was having" or "possessed")
- v. 6 Jesus had declared God to them, Jn. 1:18; 14:8-11. The total interaction of the Father and the Son are presented. God had chosen the men, Christ had received them, and their response, excepting Judas, was in faith.
- v. 7 They may have little understood the fact Jesus mentioned, but they would later.
- v. 8 The message is the means of coming to truth about God—men still need to know words by which they may be saved, Acts 11:14.
- v. 9 *I am not praying for the world*—yet the men and the message they would preach, the subject of these verses, were for that world!
- v. 10 *I am glorified*—in the same way as God was glorified in Christ: by the doing of God's will. See 15:8.
- v. 11 The future, as the past, was known to Jesus. *may be* (Greek hina ōsin hen, "so that they may always be one").

even as we are one—God and Christ were perfectly agreed as to goals, etc., but individual personalities. The disciples, individual personalities, would also need to be as God and Christ.

one—see v. 21, 22, 23; I Cor. 3:8.

- v. 12 *the scripture*—the normal designation for the O.T., which implied that God had caused it to be written, thus making it not man's production alone, but God's product through men, II Pet. 1:20-21.

might be fulfilled—God could foresee the man Judas Iscariot, and the choices he would make, ultimately involving the betrayal of Jesus into the hands of wicked men.

- v. 14 Jesus and the apostles were of human nature, yet their choice had reflected attachment to God rather than to the world. Hence, the reaction of the world.

- v. 15 *evil one*—the Greek word may mean "evil" or "evil person." Probably the reference is to Satan, thus "evil one" is appropriate.

- v. 17 God's Word is the only way to faith, and faith alone causes a person to choose the way of God, setting the life possessed unto the things of God.

- v. 18 See 13:16. But God did not send Jesus into the world without love and care. As v. 19 shows, Christ made every provision that the apostles might have whatever they needed to accomplish the work whereunto they were sent.

- v. 19 *consecrate* (Greek *hagiazō*, as in v. 17, Matt. 23:17, 19; Acts 20:32; Rom. 1:7; 6:19, 22; I Cor. 1:30; 7:14; I Tim. 2:15; Heb. 9:13; I Pet. 3:15).

in truth—everyone is set apart to something, by their own choice. Jesus' prayer is that the sanctification of the apostles and later of every disciple

FINAL WEEK

might be predicated from truth, and on truth. Further, that the knowledge of that truth might be made available for all to hear, so that their choice might be to be set apart in truth.

- v. 20 *those who believe*—Jesus anticipated success. God's Word, when preached, will bear fruit.
- v. 21 The perfect unity in God and Christ is the goal of every believer. In some ways, every believer is in Christ, Who is not divided. More often than not, it is the recognition of existing unity that is lacking among disciples.
- v. 23 *perfectly one* (Greek *eis hen*, as in I Jn. 5:8). The more recognition of unity, the greater united witness disciples have. There is power in a common cause, a common mind, a common goal. Only God deserves such as this, though sadly often failing to get it.
- v. 24 The hope of glory is Christ Col. 1:27, and He is desirous that everyone realize that hope.
- v. 25 *righteous*—only God is such. The attribute of "true" can only be applied to God. All else have gone astray in error, and are unrighteous. Hence, by our faith God makes us righteous by His son, Who did not sin at all, but became sinful so that we might become the righteousness of God in Christ, II Cor. 5:21.
- v. 26 To know God is to know His will, and to love Him is the direction of that will. Hence, our mission is to know God, and to make Him known to others.

QUESTIONS

703. How did Christ glorify God before the time of this prayer?
704. What is eternal life, as Jesus spoke of in this chapter?

NEW TESTAMENT HISTORY: THE CHRIST

705. Does the same idea in v. 6 occur in 1:1ff.?
706. How did the apostles find out that Jesus came from God—by a word revelation?
707. How many times in this prayer did Jesus state or imply equality with God? (ie., that He was more than a mere mortal.)
708. In what way were the apostles to be one, v. 11?
709. Did Jesus pray that the disciples might be able to escape the world or have victory over it?
710. Is sanctification by choice or does God automatically do it for us?
711. Could one disciple convince someone who was lost that Christ had been sent to this world by God even though that disciple was "out of fellowship" with all others around him?
712. Are all disciples to be "one" in a literal sense or a figurative sense?
713. Does knowledge of God's love come other than through His revealed Word?

(18)—Matt. 26:36-46; Mk. 14:32-42;
Lk. 22:39-46

Matt.

v. 36 Gethsemane, a small garden on the slope of Mt. Olivet which faced the city. The name itself meant oil press in the Aramaic language.

sit here—eight men were left. Peter, James and John went a bit farther with Jesus. He finally separated Himself from all to pray.

v. 37 *sorrowful and troubled*—no one really comprehends the reasons why Jesus felt as He did in the garden. He had no problem foreseeing His victory over sin, predicting His resurrection from the tomb, and His return to heaven. Hence, the issue seemingly involves the emotional side of Christ—remember, He

was not less human than we, and the foreknowledge of betrayal, trials and crucifixion would now loom large in Jesus' mind.

- v. 38 *soul*—often translated as life. The Greek word *psuchē*) sometimes was used in the Bible to refer to the total person, sometimes to the part of a person not material, sometimes to the principle of life itself, sometimes one of the characteristics of the spirit (since a characteristic of the spirit is life as well as other aspects of personality).

unto death—it is certainly questionable to say that Jesus was afraid of dying here. He had already spoken of His crucifixion and resurrection as facts. We take Him to be trying to impress the men with the great stress under which He labored, that they might feel obligated to pray with Him (which they did not do).

- v. 39 *cup*—see Matt. 20:22-23. He spoke of it to Peter in Jn. 18:11. It represented the cross specifically, the will of God for His life generally.

- v. 41 *watch*—as in Matt. 25:13. The disciple must learn to be aware of his own responsibilities, yet asking God for help in whatever area he feels helpless.

spirit—the “real” us, which animates the body.

flesh—the house in which we live. See Rom. 8:3.

- v. 43 *their eyes were heavy*—after a heavy meal and much emotional stress, plus being late at night, it is not surprising that the disciples were sleepy.

- v. 44 Cf. Matt. 6:7; II Cor. 12:8.

- v. 45 The verse can be translated several ways with about equal justification for any way. It could be understood for example, as “Sleep on, and take your rest (you are not doing what I ask of you anyway, Besides) My betrayer is here.”

Mark

- v. 35 *hour*—the appointment at Calvary.
- v. 36 *all things are possible*—God could have let us die in our sins, or saved us other ways, but the way of the cross was to lead home.
- abba*—the same as “father.” However, it was used as a term with the connotation of tenderness.
- v. 40 How could they answer—they had no good reason.
- v. 41 *the hour has come*—and Judas had all but earned the 30 pieces of silver.

Luke

- v. 39 *his custom*—so when the upper room was vacant when Judas got there, he knew where Jesus very probably was.
- v. 41 *a stone's throw*—whether from the group of 8 or the group of 3 is not said.
- v. 43 There is considerable evidence pro and con for the inclusion of this verse and v. 44. R.S.V. includes it, but footnotes the fact of its uncertain basis.
- v. 44 *for sorrow*—Luke has this interesting phrase. Perhaps the disciples were in some ways upset, not only within themselves but about themselves. Cf. Jn. 16:6, 20.

QUESTIONS

714. When did Jesus go to Gethsemane? What was the time: day or night?
715. Does the text say at what hour they got there, or how long it was before Judas came?
716. Is it wrong to pray the same words over and over?
717. Did Jesus say that He was unwilling to do God's bidding?
718. How did Jesus expect the disciples to avoid temptation?

FINAL WEEK

719. Jesus described the "hands" into which He was betrayed—what kind of "hands" were they?

Matt. 26:47-56; Mk. 14:43-52; Lk. 22:47-54a;
Jn. 18:1-11

- v. 47 Matthew identifies the crowd as Jewish, not Roman.
- v. 48 A kiss was a common greeting for friends, so nothing unusual about this gesture.
- v. 49 As John's account indicates, Jesus spoke to the crowd. Perhaps in the darkness and the hurry of Judas, he was far enough ahead of the rest that the exchange between him and Jesus could take place and Jesus still speak to the crowd as John's account records.
- v. 53 The total dedication of Jesus to the accomplishment of God's will is clearly shown here, and in v. 54.
- v. 55 A condemnation of the crowd, and a subtle hint that they were not only wrong in arresting Him by despicably cowardly in the manner they were doing it.
- v. 56 They left because they could not understand why Jesus would neither fight nor run, and would permit such to happen to Him needlessly.

Mark

- v. 44 *safely*—lest Judas lose his reward, or fall under the ire of the Jewish hierarchy for failure to carry out his bargain.
- v. 45 *kissed* (Greek *kataphileō*, a "fervent" kiss).
- v. 51 This is often said to refer to John Mark, the author of the epistle. However, it could have been anyone. The city and surrounding area would be filled with visitors for the Passover Feast, and most anyone might have been in the garden.

Luke

- v. 48 A kiss is a greeting for friends, not betrayers.

- v. 51 *no more of this* (Greek *eate heos toutou*, which comes over into English with the idea of 'allow' or 'permit unto this point'). The problem is: to whom was Jesus speaking—the disciples or the others? Did He mean allow the men to escape without retaliation for Peter's act, or allow the arrest to be made?
- v. 53 The ruler of the world had no power over Jesus, but he did over other men.
- v. 54 *high priest*—Luke means Caiaphas, as he omits the visit to Annas, which John records.

John

- v. 3 Judas went there—perhaps he knew that Jesus was not going to stay the whole night in the room. But if he did not and went there first, failing to find Christ there, he would next go to Gethsemane, where Jesus likely would be found.
- v. 4 As suggested in the section of exposition, John does not record the kiss by Judas. We suggest it may have occurred prior to the statement in this verse.
- v. 5 This verse may indicate either that Judas had not come up to kiss Jesus yet, or that he had already kissed Jesus, but Christ had control of the situation. The darkness may have entered into the problem of identification, even with the torches. Maybe the fact that it was Jesus Whom they were arresting added apprehension to the men.
- v. 8 *let these men go*—Jesus made provision for the disciples, even in spite of their upcoming failure.
- v. 9 Ch. 17:12.
- v. 10 John identifies the one who cut off the servant's ear and identifies the slave as Malchus. He must have known some in the household of the high priest to have this information, and be able also to get in the courtyard, and get Peter in also, v. 15.

QUESTIONS

720. How would you reconstruct the accounts to get in all the details each Gospel records?
721. Why do you suppose the men, armed and in number, fell back before Jesus?
722. Why did Peter just cut off the man's ear? Would that be difficult to do and not hurt him otherwise?

(19)—John 18:12-24

John

- v. 13 Annas, the high priest appointed by Quirinius, the proconsul of Syria, ca. A.D. 7. Later removed by Valerius Gratus, procurator of Judea. He had managed to get four sons appointed high priest, and the son-in-law, Caiaphas. Acts 4:6 mentions him as high priest, where others were named also, including Caiaphas.
- v. 14 See 11:47ff.
- v. 15 *court of high priest*—some indication is given in the accounts that either Annas and Caiaphas had met at the same place for the trial, or lived in adjoining quarters with a common courtyard.
- v. 17 This test of Peter's identity seems to be a different one than the ones mentioned in the Synoptics, or later in this chapter. It may be the same as one of the other ones mentioned. Each of the accounts mention three denials, and no more, however.
- one of this man's disciples*—if the maid knew that John was a disciple of Jesus, the association of Peter with Jesus would be a natural.
- v. 18 *charcoal*—it was probably after midnight our time, and the night air cool.
- v. 19 Perhaps Annas had not really heard Jesus personally. Maybe he was playing for time, since the arrest was

late in the night, people who were eating the Passover would have to be notified of it, and time allowed for them to gather so that the trial could be gotten over before too many people knew about the situation. They had Jesus before Pilate early in the morning, perhaps by sunrise.

v. 23 Jesus would answer like God!

QUESTIONS

723. What do you know about Annas (Ananias is an alternate spelling)? Caiaphas?
724. How did Peter and John get in the courtyard to watch the proceedings? (Did all the disciples who forsook Jesus and fled stay "fled?")
725. How do you understand Jesus' statement "I have said nothing secretly" when He had taught His disciples many times apart from all other people?

Matt. 26:57-68; Mk. 14:53-65

Matt.

- v. 57 *scribes and elders had gathered*—probably describing the Sanhedrin. The appearance before Annas probably gave the men time to be summoned and to gather. Read Luke 23:50-51 about Joseph of Arimathea.
- v. 59 *false testimony*—life was cheap when the fortunes of a nation and vested interests were at stake.
- v. 60 *found none*—that is, none to agree as Mk. v. 59 points out.
- v. 61 The Jews would treat such a deed by Jesus as an affront against God, even as they challenged Him when He cleansed it of people and animals.
- v. 63 Jesus did not need to answer false testimony. However, when placed under oath, He affirmed what Caiaphas asked about His identity.

FINAL WEEK

v. 64 The Greek text (su eipas 'you said') could be understood in at least two ways: either "You said it, but I didn't" or "Yes, I am what you asked of me." That the last is the correct interpretation is borne out by the action of Caiaphas and the men: they understood Jesus to affirm that He was the Messiah, the Son of God, which they considered wrong and thus blasphemy.

You will see the Son of man—this also affirms that He was what He always claimed to be: deity.

v. 66 As Lev. 24:15-16 stated. How tragic that they were such sticklers for this, while ignoring that one in Deut. 17:6 about establishing every fact by two or three witnesses (not to mention their ill-gotten witnesses with false testimony, etc.).

v. 68 Mark's account records that His face was covered before the blows struck, v. 65.

Mark

v. 55 It is interesting that the men had determined to put Jesus to death, but were unwilling to do it illegally!?!

v. 58 Their quote was a perversion of what Jesus said in Jn. 2, but the fact that He had said something was vividly remembered.

v. 61 Judges hardly have the right to be prosecutors at the same time.

v. 62 *I am*—the solid affirmation of deity. See Jn. 8:58 for the identical expression.

v. 63 *mantle* (Greek chitōnas, the "coat" of Matt. 5:40, the inner garment, not as important as the outer garment, the himation. However the chitōnas would have been the proper garment to tear).

QUESTIONS

726. Who was gathered at the house of the high priests?

NEW TESTAMENT HISTORY: THE CHRIST

727. How close to Jesus was Peter during the trials?
728. Why would Jesus not answer Caiaphas when asked about responding to the (false) witnesses, but did respond when asked about His identity?
729. What answer do you think Jesus gave to Caiaphas? Why do you think so?
730. What did the high priest and the council think He said: "yes" or "no" to the question of Caiaphas? (See Jn. 19:7.)

Matt. 26:69-75; Mk. 14:66-72; Lk. 22:54b-65;
Jn. 18:25-27

Matt.

- v. 69 The first accusation and denial. This may be the same incident as in Jn. 18:17.
v. 71 Peter moved after the first question out into the fore-court, perhaps where the gate into the courtyard was.
v. 73 The third denial. John v. 26 identifies this man as a servant of the high priest.
your accent—the influx of Gentiles of all varieties in the area of Galilee had modified the Aramiac spoken there. So Peter's speech revealed it. The text in Judges 12:1-6 comes to mind here.
v. 74 Most fail to read the text properly, misinterpreting the words "curse" and "swear." Peter was affirming the fact that he was a disciple of Jesus. He pronounced a curse upon himself if his affirmation was untrue, and called God to bear witness with him.
v. 75 Mark's account informs us that this crowing was the second. The other accounts simply affirm the rooster crowed. Someone has suggested that the crowing of the rooster was used by God to convict a man of sin, much as God uses other things of a material nature (Psalms 19:1ff.) to proclaim truth.

FINAL WEEK

If so, it was a very short "sermon" that got great results!

bitterly (Greek *pikrōs*, 'bitterness' or 'animosity' as in Acts. 8:23; Rom. 3:14; Eph. 4:31; Heb. 12:15; James 3:11; 14.).

Mark

v. 66 *below*—probably the living quarters were on the second floor, above the courtyard.

v. 68 *know nor understand*—Peter attempted to be plain, but his speech was too plain (Matt. v. 73).

Luke

v. 56 Perhaps the way Peter got in was to keep in the shadows, and not be seen.

v. 61 The theme for several songs is found in this verse. Jesus was quite aware of Peter, though being mis-handled, and Peter was close enough to "see" the end (Matt. 26:59).

v. 65 *reviling* (Greek *blasphēmō*, as in Matt. 12:31; Mk. 14:64; Rom. 2:24; etc.).

against (Greek *eis*, often with the idea of direction towards, into).

John

v. 26 Malchus had relatives, and apparently at least one of them was an observer of the events in the garden.

QUESTIONS

731. Name the people who accused Peter about his relationship to Jesus.
732. Why would Peter feel like he had to deny the relationship?
733. Do you think Jesus "looks" at us when we deny Him?
734. If the rooster was crowing, what time was it likely to be?

Matt. 27:1-2; Mk. 15:1; Lk. 22:66—23:1

Matt.

- v. 1 This text seemingly presents the idea of an official meeting at daybreak, the one prior to this being "unofficial" in the sense that Jewish jurisprudence was against trials at night. The result was the same anyway.
- v. 2 Pilate was doubtless less than thrilled to be bothered at such an early hour.

Mark

- v. 1 *whole council*—perhaps excepting such as Joseph of Arimathea.

Luke

- v. 66 Luke skips the informal meeting in Matthew 26 and Mark 14, and records the "official" meeting and condemnation.

QUESTIONS

735. Upon what evidence was Jesus sentenced to die?
736. What were the reasons for leading Jesus to Pilate?

Matt. 27:3-10

Matt.

- v. 3 *repented* (Greek *metamelomai*, as in Matt. 21:30, 32; II Cor. 7:8; Heb. 7:21). The translators have done the public a disservice in translating the Greek term by repentance. The word means 'to be sorry of' and brings about a change of mind, though it is not that change of mind. The Greek term *metanoëō* means repentance, i.e., a change of mind. Judas obviously did not change his life, but continued to do things his own way. The rest of the disciples repented, and did the will of the Lord.
- v. 4 *betraying*—John and Peter were not the only ones

FINAL WEEK

at the trials to know about Jesus' condemnation. One can but wonder if Peter and John saw him there, or if Jesus saw him.

v. 6 *It is not lawful*—such hypocrites! It was not lawful to buy treachery with it either, but that small item did not phase them any.

v. 9 *Jeremiah*—the quote is from Zechariah 11:12-13. The textual reading of Jeremiah rather than Zechariah may have arisen several ways: perhaps it is a textual transcription problem; or it may be that Zechariah was subsumed under the title of Jeremiah. Perhaps we have simply not found the idea in Jeremiah that Matthew found there.

QUESTIONS

737. Why did Judas think he had sinned—did he not carry out his end of the bargain with the Jews?
738. What made him think he had betrayed "innocent blood?"
739. Where did he throw the money?
740. What sort of scrupulosity did the chief priests and elders have?
741. How many different ways do the accounts describe the death of Judas?
742. In what ways did the potter's field get a new name?
743. Had the price of betrayal been foretold of Israel's shepherd?

Matt. 27:11-14; Mk. 15:2-5; Lk. 23:2-5

Matt.

- v. 11 Luke's account, v. 2, shows that the charge Pilate mentions had been logged against Jesus.
- v. 14 Doubtless Pilate felt this was a strange fellow, to not attempt to protect himself against the possibility of death. Other than affirming that He was

NEW TESTAMENT HISTORY: THE CHRIST

king of the Jews, but defining it in a different sense than it normally was used, Jesus did not answer. He only responded when the truth was demanded (or required).

Mark

v. 4 The question of Pilate and the answer of Jesus may have been out of hearing of the Jews. See Jn. 18:28. Hence, the charges of the Jewish leaders may have been given through an intermediary, or from a distance.

Luke

v. 2 The charges are political in nature, not religious. Had they been strictly religious, without political implications, Pilate might have reacted as Gallio in Acts 18:12-17.

perverting our nation—that is, turning it into something other than it is. Pilate probably wondered if it could get any worse. This was the charge leveled against Paul in Acts 21:28. See his response in Acts 24:10ff.; 26:4ff.

forbidding us to give tribute—of course, Jesus had done the exact opposite. There is no record of any apostle or Jesus ever breaking Roman laws, or teaching others to do so, either by word or deed.

king—like the preceding charge, the Jews implied the problem was of a political nature, which would be of concern to Pilate.

QUESTIONS

744. List the charges against Jesus as given to Pilate. Were they the same charges as in the Jewish council proceedings?
745. Did Jesus' silence imply guilt? or was He trying

FINAL WEEK

to show by silence the fact that both He and Pilate knew better?

Luke 23:6-12

Luke

- v. 7 Herod Antipas would be in Jerusalem for the Passover, trying to keep on good terms with his Jewish subjects, while not caring about them at all.
- v. 8 Herod had wanted to see Jesus for at least a year. See Matt. 14:1ff.
- some sign*—we can but surmise what Herod would have done if Jesus had really done some sign in his presence.
- v. 11 Probably the reason Jesus refused to do what Herod wanted, disdaining any act or word, was because Herod was so morally derelict that he only wanted to make Jesus into a spectacle for amusement.
- v. 12 Herod was much like his father: reprehensible to all.

QUESTIONS

746. Why did Pilate try to pawn Jesus off on Herod?
747. Why did Herod not sentence Jesus?

John 18:28-38a

John

- v. 28 *from the house of Caiaphas*—as pointed out in the section of exposition, the four accounts record different parts of the arrest and trials. We assume that John's account bypasses the first appearance before Pilate, and then the second to Herod, and picks up at the return of Jesus from Herod to Pilate.

it was early—just after the break of day.

Praetorium—the official residence (see Mk. 15:16) or judgment bar for Pilate, thus Gentile territory, considered ceremonially defiling for the Jews. One can but remark that the outside of those Jewish men was clean, but the inside was full of dead bones and every uncleanness.

- v. 29 *Pilate went out*—as suggested above, the charges of the Jews to Pilate and Jesus' conversation with Pilate might have taken place in separate locations.
- v. 31 Pilate could tell that the charges were trumped up. However, he may not have caught the idea totally that they were determined to take Jesus' life, whether or no, rather than just imprisonment, etc.
- v. 34 Pilate had asked him once, and Jesus had responded. Now Jesus was trying to get Pilate to face up to the facts.
- v. 35 Pilate evaded the question by asking another.
- v. 36 Jesus reaffirmed His kingship, but defined it in such a way that Pilate could see the problem was not as the Jews had made out.
- v. 37 Jesus repeated the facts about Himself, though changing the implication of the word "king" and asserting that He was of such nature that the issue was much different than the world understood it.
- v. 38 whether this is cynical, or flippant, or a question for information is not clear. Pilate seemed to care little for truth but who knows?

QUESTIONS

- 748. Was ceremonial defilement worse than moral defilement? (Cf. Mk. 7:14-23.)
- 749. How many different ways is "passover" used in the Bible? (Cf. Lk. 22:1.)
- 750. Since the Jewish leaders were "keepers of the law,"

FINAL WEEK

do you suppose the Passover meal had been eaten the night before, according to the law?

751. What was the need to take Jesus to Pilate?
752. Did Jesus actually deny that He was a king in the sense the Jews had accused Him?
753. What was truth as Jesus understood it?

Matt. 27:15-23; Mk. 15:6-15; Lk. 23:13-25;

Jn 18:38b-40

Matt.

- v. 15 The custom was probably a political expedient. However, Pilate may have seen this custom as a way out of the sticky problem in which he found himself: an innocent man and a belligerent mob.
- v. 16 *notorious* (Greek *episēmos*, originally used to describe something bearing a mark, as stamped money, etc. Then it came to be applied to anything marked by something distinctive or outstanding).
- v. 17 There is an interesting textual reading for the end of v. 16, which indicates that Barabbas may also have been labeled "Christ." Considering the charges against him, it is not too surprising that some called him "Christ" (Messiah).
- v. 18 *that for envy*—this is the knowledge that condemns Pilate.
- v. 19 Everybody affirmed in one fashion or another the innocence of Jesus, but nobody acted upon that knowledge.
- v. 20 The chief priests and elders were omnipresent and hyperactive to get Jesus killed.
- v. 22 Luke's account will show he made more effort to sway the decision for Jesus, even before the scourging. John's account will record another attempt to release Jesus after the scourging.

NEW TESTAMENT HISTORY: THE CHRIST

v. 23 The cheerleading Jewish hierarchy had the group in frenzied unison, and truth was shouted down.

Mark

v. 7 *rebel . . . murder . . . insurrection*: rather than Jesus!

v. 11 *stirred up* (Greek *anaseiō*, from *ana* 'up' or 'back again' and *seiō*, 'shake' or 'agitate'). The chief priests had accused Jesus of doing this, Lk. 23:5. They created havoc with the people present, and Pilate was unwilling to face the storm.

v. 14 *what evil*—many thought Jesus had done evil, but Pilate knew who was evil, and it was not Jesus.

v. 15 The Synoptics do not record that Pilate scourged Jesus, and then presented Him back to the crowd for another try at releasing Him.

Luke

v. 14 not guilty! Which fact made Pilate and the Jews all the more so.

v. 22 *no crime*—Pilate was willing to go along with the game, until the real intention of the Jews became evident. However, as he mentioned to Jesus in Jn. 19:10, he could have overridden that opposition had he been as morally strong as he was intellectually sharp.

John

v. 38 He had to go where they were, outside the praetorium.

v. 40 *robber*—see Matt. 26:55; Lk. 10:30, where this word occurs.

QUESTIONS

754. How many times has Pilate attempted to release Jesus?

755. Who declared Jesus to be evil?

FINAL WEEK

756. Why did Pilate finally release Jesus to be crucified, according to the text?
757. Of what was Barabbas guilty? (Of what did the Jews accuse Jesus?)

Matt. 27:24-31; Mk. 15:16-20; John 19:1-16

Matt.

- v. 24 *a riot*—He could have quelled it like the one in Acts 21:31ff.
- v. 25 *his blood*—they passed the sentence truthfully. See Acts 2:23.
- v. 29 The soldiers see only a hated Jew, rejected by even his own people, so lacking in “fight” that he will not even defend himself. They also see someone who was purportedly “king” of the Jews, and thus an object upon which to vent their distaste for the nation.
- v. 30 *on the head*—encircled with a thorn crown.

Mark

- v. 19 *homage* (Greek *proskuneō*, ‘to worship’ or ‘to reverence’, etc., as in Matt. 4:10; 18:26; Mk. 5:6; Acts 10:25; 24:11; I Cor. 14:25; Heb. 11:21; Rev. 9:20; 22:8; etc.). Of course, the worship was mockery, and sport for them.
- v. 20 *mocked* (Greek *empaizō*, as in Matt. 2:16; 27:29, 31, 41; Mk. 10:34; 15:31; Lk. 14:29; 18:32; 26:63).

John

- v. 4 Pilate tried one more time to arouse feelings of shame and righteousness, but to lose again.
- v. 5 *the man*—He knows about persecution, and heartache, and shame, and rejection. See Heb. 4:1ff.
- v. 8 *more afraid*—perhaps he had been afraid for himself and his position politically (Matt. v. 24). He may now have had some misgiving about “truth” in other realms.

- v. 11 Every society has the God-given right to govern itself, and thus to have men in office to carry out that principle. Each official then represents God's will, at least as far as the basic idea of government may be concerned. The practices of that official, or the specific laws he enforces may not be "godly" though the right of the position to exist is.
- greater sin*—but all are sinful: Annas, Caiaphas, the Jewish rulers (Acts 13:27-28), the people, Pilate, etc. Jesus prayed for their forgiveness, Lk. 23:34.
- v. 12 They put their tongues right on his tenderest point: his job. The world won.
- v. 15 *We have no king*—how truthfully they answered though they hardly realized it. They did have a judge, though. His name was Jesus.

QUESTIONS

758. Did Pilate's action of washing his hands impress the crowd, or present their part in the proceedings in any better light?
759. What satisfaction did the soldiers get out of the trials?
760. Did the real issue between the Jews and Jesus finally come out in the open?
761. Is the assertion of the Jewish leaders in Jn., v. 15, a lie and blasphemy? (See I Sam. 8:7.)

Matt. 27:32; Mk. 15:21; Lk. 23:26-31

Matt.

- v. 32 *Cyrene*—probably in Africa, the capital of a district known as Cyrenaica. It was a Greek city-state, but had Jews in it, or from it, Acts 2:10; 6:9.

Mark

- v. 21 *compelled* (Greek *angareuō*, 'to compel' or 'to requisition' as in Matt. 5:41).

FINAL WEEK

Luke

- v. 26 Just why Simon was picked on is not stated. Maybe he just happened to be in the wrong place at the wrong time. John 19:17 seemingly indicates that Jesus started with the cross, but John does not mention Simon at all. Maybe Jesus never actually carried the cross at all.
- v. 27 The word had gotten around by this time, and friends of Jesus had begun to gather. However, Jesus was in the clutches of the Romans, and weeping was all that could be done.
- v. 28 His punishment would soon be over, and was for an entirely different reason. Their's would be lengthy, and because of their own sin as a nation.
- v. 30 But the mountains would not fall, nor the hills answer. The Roman armies did!

QUESTIONS

762. Where did Simon fit into the crucifixion?
763. How far did Simon carry the cross?
764. Whose punishment would be just; Christ's or the Jewish nation's?

(20)—Matt. 27:33-44; Mk. 15:22-32;
Lk. 23:32-43; Jn 19:17-27

Matt.

- v. 34 *gall*—perhaps the same substance as the myrrh in Mk., v. 23. However, the Greek terms are different. Perhaps the substance had two names, or both substances were mixed in the wine. Myrrh was one of the gifts the wise men brought. It was obtained from a tree that grew in and around the southern tip of the Sinai peninsula, as well as in other places. The product of the berries is bitter to taste, and

often used as an antiseptic or stimulant, though also for embalming, Jn. 19:39.

- v. 36 *sat down*—sometimes victims lived for days before dying. Thus the soldiers sat down to endure until it was over.
- v. 37 *the charge*—the accounts all vary, but the same message is in all: (the man on the cross below is) Jesus, King of the Jews.
- v. 38 Barabbas had been a robber, and Jesus died in his place. All have robbed God of the rightful honor He deserved, and Jesus died in the place of those people, too.
- v. 39 *passed by*—the spot may have been near a road from the city.

deride (the Greek word is often translated as “blaspheme”).

wagging (Greek *kineō*, ‘to nod’ or ‘to move up and down’ as one’s head).

- v. 42 *we will believe*—Jesus would have said of them “A wicked and adulterous generation seeks after a sign.”
- v. 43 Their point was that if Jesus were God’s Son, surely God would not permit His Son to die. Conclusion: he is not God’s Son.
- v. 44 See Psalms 22:6-8, 12-13; 69:19-20. The robbers one could understand, but chief priests and elders?? It seems like something of God would show through.

Mark

- v. 23 *myrrh* (Greek *smurna*, ‘Smyrna’. The word is from the Hebrew root *mor*, ‘bitter’. The liquid is of a reddish-yellow color when obtained from the fruit of the small tree producing it.

he did not take it—consider Jesus the man: the night of sleeplessness, anxiety, heartache, mistreat-

FINAL WEEK

ment, scourging, and crucifixion—but He is still man, all man!

- v. 25 *third hour*—Jewish time, 9:00 a.m. our time. Jn. 19:14 is 6:00 a.m. our time.
- v. 31 *he saved others*—true, but truer: he is saving others than Himself, including them.

Luke

- v. 32 *criminal* (Greek kakourgos, only here, in v. 39, and II Tim. 2:9).
- v. 33 *the Skull* (Greek kranion, our cranium by way of Latin).
- v. 34 *know not*—perhaps Jesus meant that the facts of what they were doing were clear, but the meaning of them was not.
- v. 35 *scoffed* (Greek ekmuktērizō, from muktēr 'nose,' then to hold the nose up in derision. The rulers ought to have been pretty well practiced on this trick).
- v. 39 *railed* (Greek blasphemeō).
- v. 40 *fear God*—just what he meant here is unknown. Did he mean emphasis upon fear? you? God? Did he mean "Don't add to your sin by speaking evil" or that the man should be as Jesus, not finding fault with others, etc.?
- v. 41 He confessed his sin, the first step to forgiveness.
- v. 42 *remember me*—did he mean for the present defense, or for previous encounters?

John

- v. 18 Isa. 53:12 is fulfilled.
- v. 20 Pilate made sure that anyone could read the inscription, regardless of nationality. The differences in the accounts of the inscription in the Gospels may be due to the language they used as a basis for transcription into Greek.

- v. 22 Pilate perhaps thought he could get even (or one up) on the Jewish hierarchy by what he wrote. In any case, the truth about which Pilate asked prevailed.
- v. 23 *tunic* (Greek *chitōna*, 'coat' in Matt. 5:40; mantle in Mk. 14:63).
- v. 24 Psalms 22:18.
- v. 26 Perhaps John, after Peter left weeping because of his denials, stayed with Jesus, and went along with the procession to the cross.
- v. 26 *son*—assumed to be Jesus or John? (remember—son is used a variety of ways in the Scripture, and John was Mary's nephew.)
- v. 27 *his own home* (the Greek expression *ta idia* is like that in ch. 1:10a, and may mean in his keeping, etc., which might include a home. She still had sons, though, including James who was in the Jerusalem church for years, Acts 15:13).

QUESTIONS

765. Which account shows that one of the two thieves stopped reviling Jesus and started reviling the other thief?
766. What mixed drink was offered to Jesus? Why was it offered?
767. What differences in wording are there between each of the four accounts of the inscriptions Pilate placed on the cross?
768. Into how many parts were Jesus' garments divided?
769. For what part did the soldiers gamble?
770. How many different "titles" did the chief priests, elders and scribes ascribe to Jesus?
771. Did the one thief think Jesus should have saved them all?

FINAL WEEK

772. Why did the one thief rebuke the other one?
773. What is Paradise according to the Bible?
774. When Jesus came back from the tomb, where do you suppose He stayed during the 40 days on earth: at John's house? (Remember, John lived in the vicinity of Capernaum until Jesus called him.)

Matt. 27:45-50; Mk. 15:33-37; Lk. 23:44-46a;
Jn. 19:28-30

Matt.

- v. 45 Our time would be from 12:00 to 3:00 p.m.
v. 46 It is not said whether the cry was before or after the darkness ended.
v. 47 In spite of the loud voice, the words of Jesus were not clearly perceived by some, and they thought He had uttered something in regard to the prophet Elijah. Maybe they had in mind the prophecy in Mal. 4:5-6.
v. 50 *loud*—the cry to which Matthew refers may be unrecorded, or either of the utterances in Lk. v. 46 or John v. 30. The cry of Luke seems more likely to be the one.

Mark

- v. 34 Psalms 22:1
v. 36 Though Jesus had refused (He tasted it, but did not drink) the drink earlier, perhaps the moistening of His lips might have been welcome.

Luke

- v. 45 *failed* (Greek *skotizō* 'to darken'). The text does not indicate why it failed, if something came between the sun and the earth, or if God simply caused the sun to quit shining.
v. 46 *spirit*—the real person, which is probably the part of each human that is made in God's image, at least partially, since God is spirit.

breathed his last—the spirit left the body, taking with it the life inherent in the spirit, and the body ceased to function. See James 2:26; Ecclesiastes 12:7.

John

v. 28 *I thirst*—Psalms 22:15 or 69:21b may be the references.

v. 29 *vinegar*—a sour wine, some suggest. Whether the same or different than that mentioned earlier is not known. Jesus did not necessarily drink any, though perhaps the wet sponge would help relieve the thirsty condition.

v. 30 *It is finished* (Greek *tetelesthi*, from *teleioō*, 'to complete' or 'to finish'. The form is in the perfect tense, indicating a past condition true up until the moment of speaking).

QUESTIONS

775. How many hours of darkness were there?

776. How did God forsake Jesus? Can anyone actually get away from God? Consider Psalms 139:7-12.

777. Did Jesus uphold the sentence of the law upon sin?

778. What did Jesus mean was finished—His life? the agony? the purpose for which the Jewish leaders had Him crucified? or what?

Matt. 27:51-56; Mk. 15:38-41; Lk. 23:46b-49;

Jn. 19:31-37

Matt.

v. 51 The text implies that the earthquake, etc., occurred at the time of Jesus' death. The extent of the earthquake is not mentioned, but the effect upon the Roman centurion and the soldiers was considerable.

tombs—whether the raising of the saints and their

FINAL WEEK

appearance occurred after Jesus' resurrection or not is unclear. Maybe they were raised at the time of the earthquake, and appeared after the resurrection.

- v. 54 *filled* (Greek sphodra 'much' or 'exceedingly').
v. 55 The news had traveled, and some of those who followed Jesus had come to the cross. We will meet them again as they come to the tomb after the burial.

Mark

- v. 39 *thus*—the death of Jesus was not just any death, as the man could see.
v. 41 The women were not required to attend the Passover Feast, but many would have other reasons to attend, such as cleansing, offerings, etc.

Luke

- v. 47 *praised God*—this may refer to the statement he made about Jesus, or to other expressions not recorded.
v. 48 Apparently many were gathered from the city besides His disciples. Since the feast was in progress, there would be a great influx of people to observe it, who would not otherwise be there. Many of these people may have been at the cross.

John

- v. 31 The men were not yet dead, so the process has to be hastened. Were the following day not the Sabbath, the Jews would not have been so concerned, but they did not want to chance having to leave dead bodies on the cross over the Sabbath.
v. 33 *already dead*—the men were rather positive about this, because Pilate inquired about it before he would let Joseph have it.
v. 34 It is not so important that blood and water came out, as it is that the soldier pierced His side, making sure the man on the middle cross was dead.

- v. 36 Psalms 34:20.
 v. 37 Zech. 12:10. 13:1 states that a fountain shall be opened for the house of David and the inhabitants of Jerusalem to cleanse them from sin and uncleanness. The fact stands accomplished!

QUESTIONS

779. Why do you think the temple veil was rent in two?
 780. The Roman centurion meant that Jesus was the Son of God: affirm or deny and tell why.
 781. How could Jesus have nails in both hands and feet, plus a sword thrust, and yet have no broken bones?

Matt. 27:57-61; Mk. 15:42-47; Lk. 23:50-56;
 Jn. 19:38-42

Matt.

- v. 57 *evening*—the two or three hours before sunset.
also a disciple—among other Jewish leaders (Jn. 12:42-43) along with Nicodemus.
 v. 59 *clean linen shroud*—Nicodemus furnished spices, Joseph the grave cloth and grave.
 v. 60 *new tomb*—it may have been only big enough for him, or perhaps it was a tomb large enough for several people, as a whole family.

great stone—since Joseph rolled it himself, it may not have taken too much to roll it back. The women later wondered who would roll it back, but they may have been thinking about the Roman seal, or the guard of soldiers rather than the size of the stone.

Mark

- v. 42 *Preparation*—Friday. The next day was Saturday, the Sabbath. No other day in the Scripture is called Sabbath except Saturday.

FINAL WEEK

- v. 43 *looking*—he at least did not have his mind completely closed to Christ.
- v. 44 *Pilate wondered*—so much so that he would not let Joseph have the body until the centurion affirmed Jesus was actually dead.

Luke

- v. 50 *Arimathea*—some suggest this town was located in the hill country of Ephraim, north and west of Jerusalem.
- v. 52 *This man*—perhaps the disciples had left the scene, or were not even aware that Jesus was dead.
- v. 54 Matthew and Mark identify the women as Mary Magdalene and Mary the mother of Joses.
- v. 56 The burial was done in haste, and the women wanted to prepare spices (They had not expected Jesus to be killed, hence had made no preparations.) so that early on Sunday morning they could return and complete the job before decomposition became such that they could not do so.

John

- v. 38 *for fear*—after the resurrection and Pentecost, many of the Jewish rulers of the same mind as Joseph became open followers as Acts 6:7 shows.
- v. 39 *a hundred pound's weight*—a great amount, significant of his esteem for Christ. It had taken some time for the Spirit to move in his life, but change was evident.
- aloes*—a sweet perfume, made from a pulverized wood.

QUESTIONS

782. How many things do the accounts tell about Joseph?
783. What do you know about Nicodemus?

784. What did each of the men furnish for the burial?
 785. Where was the tomb and what kind of tomb was it?

Matt. 27:62-66

Matt.

- v. 26 It would be Saturday, but the day would begin at sundown. The rulers may then have gone to Pilate at or near sundown rather than following the night.
 v. 64 The point was: they did not think Jesus would be resurrected at all, but they did not want the disciples to steal the body and then affirm Jesus had kept His word about rising on the third day. They only added to the evidence against anything being true about the empty tomb except that Jesus came out of it by the power of God.
 v. 65 *You have*—the Greek verb can either be imperative or indicative. Hence, we are not sure which Pilate said, but the guard was given, the tomb sealed, and the stage all set for the Son of God to rise on the third day.

QUESTIONS

786. Why did the rulers care about only keeping the tomb secure until the three-day period was over?
 787. What fraud would be worse than the first fraud?
 788. Why would the chief priests think the disciples would or could steal a body and attempt to convince people that Jesus arose?
 789. Did the disciples have any plans for doing what the chief priests thought they might?

(21) and (22)—Matt. 28:1-10; Mk. 16:1-8;
 Lk. 24:1-11; Jn. 20:1-18

Matt.

- v. 1 Perhaps this took place at sundown Saturday.

RESURRECTION

- v. 2 Matthew does not state when the earthquake occurred, just that it happened. The statement in v. 5 may have been to the woman who came to find the stone rolled back, the guards gone, and the angel suddenly appearing to them, all of which would bring fear and uncertainty upon them.
- v. 4 *dead men*—but they were later to testify to a much different story, vv. 11ff.
- v. 5 *crucified*—but now alive!
- v. 6 He had predicted His suffering and resurrection at least six different times.
- v. 7 *go quickly*—they had the facts by virtue of their own senses, and now were to tell the good news.
to Galilee—Matt. 26:32. They met Him there, as Matthew's account shows, vv. 16ff.
- v. 8 *ran*—with every reason to run, and every reason good!
his disciples—probably the apostles, plus others who were around.
- v. 9 He greeted them, and they while assuring themselves that it was no phantom by touching Him worshipped Him.
- v. 10 *Do not be afraid*—the Greek construction implies that they were to stop being so. Mark's account, v. 8, shows their state of mind prior to the meeting with Christ.

Mark

- v. 1 As suggested above and in the section of exposition, this purchase of spices may have been done on what would be our Saturday evening, so that they could leave for the tomb even before sunrise the next morning to finish the anointing.
- v. 2 The women apparently left for the tomb while it

was yet dark, or at least very early dawn (Luke v. 1); but arrived after the sun had risen.

- v. 4 *it was very large*—the size of it, or the way in which it was lying plus its size may have been the problem in their minds.
- v. 5 Mark does not affirm that the angel in the tomb was the same as the first one they had seen, only that they saw him in the tomb. He may have been the same angel as was outside, or the two accounts may be telling of the same incident.
- v. 6 *He has risen*—the angels do not say when, only that the fact was so. None of the accounts say when or how Christ left the tomb. They only record that the women came and found it empty, with Jesus having arisen earlier.
- v. 8 The women were not expecting any resurrection, let alone a conversation with angels. So their reaction was rather natural, considering what the empty tomb implied about Jesus.

Luke

- v. 1 *they*—the other accounts name some women, and Luke adds Joanna to the list. The “they” refers back to the women in 23:56.
- v. 4 Mark’s account only speaks of one angel, but does not deny that two were present.
- v. 6 No account records Jesus telling this to the women, but lots of things are not recorded that Jesus said and did. The “you” may mean the disciples in general however, rather than the women in particular.
- v. 9 *eleven*—maybe the men had assembled by this time, or were staying together. It may be that they just scattered and each woman told some of the disciples what they had seen.

RESURRECTION

John

- v. 1 John only tells of Mary. The other Gospels show that others were with her. She implies as much by the use of "we" in v. 2.
- v. 2 *we do not know*—she had left before seeing the angels or getting the same message from Jesus as the other women. So she still assumed someone other than the disciples was responsible for the removal of the body.
- v. 5 *cloths*—if stolen, who would go to all the bother to unwrap Jesus, and transport a body in such a state?
- v. 7 *in a place by itself*—all was in orderly fashion, something different than if someone had stolen the body.
- v. 8 *he saw and believed*—believed what? that the body was gone as Mary had said? Apparently none believed when Jesus appeared to them in the room that evening.
- v. 9 *did not know*—does this mean they remembered Jesus' words but did not yet understand the meaning of them?
- v. 11 She had followed Peter and John back, but seemingly did not meet them after they left the tomb, or if she did, did not hear anything from them to change her mind about what she thought.
- v. 12 Though she saw them, she either did not recognize them as being different or something, for it seemed to have had no effect on her.
- v. 15 The tomb was located in a garden.
- v. 17 *I have not yet ascended*—He may mean either that He had not been there at all, or that He had not gone to remain, as in Acts 1:9-11.

QUESTIONS

790. See if you can piece together the events in exact order, and harmonize all the accounts.
791. Which account tells all that the others tell?
792. Which account denies by explicit statement what the other account(s) affirms?
793. Was the tomb empty?
794. How many angels might the total group of visitors to the tomb have seen?
795. Did the angels know of things that Jesus had told the disciples? How could they know about such things?
796. Name the women who came to the tomb and the men.
797. Why did Jesus appear like a human to Mary? Do the accounts say He actually appeared to be any different than before to the disciples (after they recognized and handled Him)?

Matt. 28:11-15

Matt.

- v. 11 The texts do not affirm whether or not the guards saw the women or vice-versa. It seems doubtful if they did see each other.
- v. 12 *a sum of money*—to shut their mouths in two ways: 1) to make them party to the crime by taking a bribe, and 2) by making it worth their while to endure some quizzing if it came.
- v. 14 *the governor's ears*—Pilate. He was in the affair so deep that he could only keep quiet.
- v. 15 The guards did not keep it quiet, so they told their story. But some in that Jewish council may later have become Christian, and countered their story with the real truth of the matter, which we have in Matthew's account.

RESURRECTION

QUESTIONS

798. When did the guards leave the tomb—before or after the women came?
799. How long did the guards remain as “dead men” before they revived?
800. Why concoct the story that the body had been stolen, when people could easily check that story out?
801. Does Matthew indicate that anybody believed the story they told??
802. Was the story circulated that the guards had fallen asleep and the body was stolen, or that the guards and the Jewish authorities made up the whole story?

Emmaus and Jerusalem—73. and 74. Luke 24:13-43

- v. 16 The text does not say if the disciples were unable to “see” Jesus via a miracle, or if their presuppositions kept them from seeing. They just did not think Jesus was alive, and were not looking for Him.
- v. 18 Cleopas assumed that Jesus must have just arrived, or he would have known about what was common knowledge around the city.
- v. 19 *a prophet*—this idea was one of their problems. Had they been thinking about Jesus being God, their outlook might have been different.
- v. 23 The men must be referring only to the story Mary told Peter and John when she first went to the tomb. Had they seen any of the other women, or Mary Magdalene after she went back to the tomb, their story would have been considerably different, since the story then would have included the personal appearance of Jesus to the women.
- v. 24 Peter and John, and maybe others also went. They do not know about Jesus’ appearance to Peter, or else it has not happened yet.

v. 25 *foolish* (Greek *anoētos*, as in Gal. 3:1; I Tim. 6:9). He will describe how they are foolish in the following words.

all—they were ignorant of the most important idea in the O.T.!

v. 26 It was quite necessary if man was to have life. *glory*—probably in the sense of Jn. 17:5, 25.

v. 32 *burn*—their reflection and Jesus' chiding brought about this reaction.

v. 33 More than the eleven were there, though Thomas was not.

v. 34 The women to whom Jesus appeared either were not present, or only the appearance to Peter was mentioned.

v. 37 The reality had not yet imposed itself on their mind, as they still react unbelievably.

v. 38 *troubled* (Greek *tarassō*, 'to trouble' or 'to agitate'). Jesus had forbidden them to be this way in Jn. 14.1, 27; etc.

questionings—the same word as in Lk. 1:29; etc. They could not believe their senses.

v. 40 *flesh and bones*—the accounts do not indicate that Jesus' body was any different after the resurrection than before the resurrection. That is exactly the point about the resurrection: the same Jesus as before.

QUESTIONS

803. Where was Emmaus from Jerusalem?
804. What would have been the difference if Jesus had been known by the two men immediately?
805. Do you suppose anyone saw the three men as they walked toward Emmaus? If so, did Jesus look as "human" as the other two, do you think?

RESURRECTION

806. What sort of idea did the men have about Jesus' mission?
807. Upon what day did this conversation take place, reckoning from the day of the crucifixion?
808. Were the disciples really unwilling, or just terribly slow to comprehend the message of the O.T. about the Messiah's nature and mission?
809. In what common activity was Jesus revealed to the two men?
810. How many finally gathered in the room in Jerusalem that evening, sharing their stories with each other?
811. Do you think the text indicates that Jesus either appeared so normal the disciples could not believe that it was He, or so utterly different that He was not recognizable at all?
812. What do you think the disciples expected to see when they thought about a resurrected Jesus? Would their image of such a person have been identical to what Jesus had been as they knew Him?

John 20:19-31

John

- v. 19 John is very explicit about when Jesus appeared.
peace—Jesus had promised this as something only from Him, which the world could not give, Jn. 14:27; 16:33.
- v. 21 Jesus was sent with a mission to perform, a message to preach and the necessary help from God to accomplish it. The apostles were sent in the same general way as Jesus was.
- v. 22 *receive*: He commands them to be ready for the promised coming of the Holy Spirit, not many days hence.
- v. 25 To every stipulation Thomas made, Jesus complied, as v. 27 shows.

- v. 27 We assume inclusive days, ie., a week later on the following Sunday.
- v. 29 The evidence for faith is not overwhelming, but sufficient, v. 31. God has adequately provided for faith, but He does not force anyone to believe, any more than Jesus forced the apostles to accept Him.
- v. 31 *you may believe*—the initial committment to Christ: believing (Greek *pisteuontes*, a steady faith in Christ throughout life, which brings to us life, Jn. 3:36; 5:24).
- may have* (Greek *echête*, ‘keep having’ or continual possession).

QUESTIONS

813. Why were the doors shut in the room where the disciples were?
814. Why did the disciples need “peace?”
815. Did the rest of the disciples take more convincing that Jesus was Himself than Thomas did?
816. What relationship were the apostles to have to sin?
817. How many things did Thomas demand before he would believe? (Wonder how Jesus knew what he demanded?)
818. Did God cheat people by not allowing them to see Jesus in the flesh in order to come to faith in Christ?
819. Do we have life without abiding in Christ? How do we abide in Christ?

75. Galilee—John 21:1-25

John

- v. 1 John will remark that this is the third appearance, v. 14. It is in the appearances He gives. As this appearance is in Galilee, Jesus kept His Word, even as He told them, Matt. 28:10.

RESURRECTION

- v. 2 The men had gone to Galilee in obedience to the command of Jesus (Matt. 28:16).
- v. 3 While waiting for Him to appear, they decided to go fishing.
- v. 6 *right side*—they obeyed, maybe out of desperation. Fishermen are like that sometimes, when the stringer is empty.
- v. 7 The text may indicate he had little if no clothes on.
- v. 9 *fish*—Jesus did not need any of their fish.
- v. 11 *the net was not torn*—John remembered with clarity just how miraculous the whole catch was.
- v. 17 *grieved*—But Peter did not turn on Jesus because He questioned him so closely, though doubtless not understanding just why.
- v. 18 This seems to predict that Peter's life will end in prison or something similar to it. Because the implication was bad at least, Peter asked Jesus about John, v. 21.
- v. 22 One problem every disciple must overcome is comparing his life with another's. We dare not do that, as Jesus plainly pointed out. What God does, for instance, with Shadrach, Meshach and Abednego, He may not do with Daniel. What He does with James, He may not do with his brother John. The only correct attitude to hold is that expressed by Paul in Acts 20:24.

QUESTIONS

820. Who was in the fishing party? When did they go?
821. Why were they in Galilee?
822. How long did they fish without any luck?
823. Peter put on his clothes and jumped in the sea—do you suppose he had to swim to shore in clothes?
824. Why didn't the disciples have to ask who the person was that fixed breakfast for them?

NEW TESTAMENT HISTORY: THE CHRIST

825. Why did Jesus ask Peter about his love?
826. How do you think Peter felt about Jesus?
827. Why was Peter concerned about John's future?
828. How many books would it take to adequately tell all Jesus was and did?

Matt. 28:16-20

Matt.

- v. 16 He apparently had told them specifically where to go. The incident in Jn. 21 may have occurred any-time during the 40 day period, and the same is true of this event.
- v. 19 *disciples*—no word in Greek for this term. The verb used (*mathēteusate*) conveys the idea of making people from every nation into learners, or disciples.
- Holy Spirit*—an equal with the other personalities possessing deity: the Father and the Son.
- v. 20 *always* (Greek *pasas tas hēmeras* 'all the days').
close (Greek *sunteleia*, 'to bring to completion', etc., from *teleiōō*).
age (Greek *aiōn*, used to mean any age, or a long time, or kindred ideas, as in Matt. 12:32; Mk. 10:30; Lk. 1:70; 16:8; Jn. 6:51; 9:32; Rom. 16:27; Col. 1:26; Heb. 13:21).

QUESTIONS

829. How many disciples were said to go to Galilee?
830. Who worshipped Jesus? Who doubted?
831. Upon what basis did Jesus give the commands in v. 19?
832. By whose authority (in whose name) were people to be immersed?

RESURRECTION

833. Is the promise of Jesus' presence conditional, or is it stated as a fact for every generation/age?

77. Jerusalem—Luke 24:44-53

Luke

- v. 44 As we mention in the section of exposition, there is a time lapse somewhere in ch. 24. We assume it to be here, though it may be at v. 49.
- v. 43 *opened* (Greek *dianoigō*, as in v. 31, 32; Mk. 7:34; Lk. 2:23; Acts 7:56; 16:14; 17:3). It may have been miraculous, or just simply the result of proper explanation of things they had not understood because of their prejudices, etc.
- v. 46 *it is written*—the formula used to designate Scripture—very often in the N.T. (some 50 times in the Bible).
- v. 47 *in his name*—by His authority, as in Acts 3:6.
- v. 49 *the promise of my Father*—Jesus had mentioned this in Jn. 14:16; 15:26; 16:7-14, and reminds them of the coming blessing again.
- v. 50 Perhaps they had met in Jerusalem, or nearby.
- v. 51 The account in Acts 1 enlarged the ascension with more detail.
- v. 52 *great joy*—the wildest dreams they had ever had were true, and more besides. No wonder they rejoiced. Jesus had promised this in Jn. 15:11, etc.
- v. 53 *in the temple*—they were there 10 days later when God kept His promise to them, and repentance and remission of sins were proclaimed by the authority of Jesus Whom God made both Lord and Christ, Acts 2:36.

QUESTIONS

834. How did the disciples need their minds opened?

NEW TESTAMENT HISTORY: THE CHRIST

835. What had been predicted in the law, prophets and psalms about the Messiah's nature and mission?
836. What did the apostles need to start proclaiming that message?
837. The apostles were witnesses for what things?
838. How many people in Jerusalem who heard the first proclamation of repentance and remission of sins in the name of Jesus accepted that message? (Acts 2.)
839. Don't you think Jerusalem would have been a most unlikely place to preach a resurrected Jesus if the message were not true?
840. How long were the disciples in the temple praising God before the Holy Spirit came, enabling them to proclaim to the Jews on Pentecost that Jesus had been made both "Lord" and "Christ?"

GENERAL INTRODUCTION TO THE FOUR GOSPELS

God became human without ceasing to be divine: that is the united yet individual testimony of Matthew, Mark, Luke and John. While they may very profitably be studied separately, and the following introductions are thus given from that viewpoint, yet they together present the picture God wanted mankind to have. While studying each Gospel separately may bring points to one's attention that might otherwise escape, it is the firm persuasion of the writer that more harm than good is done thereby. The constant problem that is part and parcel of much modern scholarship stems partly from just this practice. For 1700 years, the scholarship of the church assumed that 1) God is, 2) had revealed Himself in Christ to this world, 3) had recorded His will for humanity in the Bible, first in the Old Testament preparing the way for His visit, and then in the New Testament, recording that visit and giving directions to men in regard to His way for them. Men began with the obvious premise that God could inspire men to write books, and specifically the books with which we are now concerned. In so doing, the portrait was complete when all four were treated as one whole. (Some did not like Tatian's harmony of the four but it was not because the four were not to be studied together. It was because *Tatian's Diatessaron* was not inspired!) The human factor was not denied nor excluded from the writing of these books, but God through the inspiration of the Holy Spirit directed that the original autographs from the hands of Matthew, Mark, Luke and John were as He wanted them to be. So far so good.

Through the centuries, men readily recognized the striking differences between the four accounts, as well as their remarkable parallels, sometimes even word for word. It was not until the rise of rationalism and its bosom

companion philosophy, evolution, that men began to play one book against another. The assertion by Lachmann (1793-1851) that Mark was the primary source really started the move. Assuming that things go from simple to complex, and that God (if there was one) had no hand in producing the four Gospels, men began to tear them to pieces. The theories of Jean Astruc in his book about Genesis (pub. 1753), appeared in an enlarged form in Johann Eichhorn's Introduction (1780-83). In this book, the ideas implicit in evolution emerged, and the position was readily picked up by others, especially in Europe. Calling the approach "The Documentary Hypothesis," men such as Vater, DeWette, Ewald, and Hupfeld propounded the basic idea that the Old Testament was a product of the evolutionary principle. The Jewish nation was the source of the Old Testament in the main rather than God. Books considered prophetic could not be so, since God (if one existed) had not revealed anything to man. Thus, as example, Isaiah was considered the work of several authors, and none of it was prophetic; Daniel was considered as having been written in the period ca. 165 B.C.

Soon this basic idea was applied to the New Testament, and it persists until now. Current scholarship has applied *source criticism* (which attempts to discern which Gospel writer copied from which) and its offspring *form criticism* (which attempts to find out how the writers got their information, how the stories were developed by the church over a period of time, which then were written in the Gospels) and its child *redaction criticism* (which purports to know what the author's purpose was in his theological creation called a Gospel, since that purpose not only determined what went into the book but conclusions from that material) to the four Gospels in general, and the Synoptics in particular. The fact that the Synoptics (Matthew, Mark and Luke) have some material common

GOSPELS INTRODUCTION

to all make them prime targets for such approaches. Actually, these three approaches to the study of the Gospels are just the theories of Eichhorn et. al in new dress. Perhaps to subsume all three under the heading of unbelief would not do them much if any injustice. In the following discussion, the main subjects will be the Four Gospels, but the arguments would apply to the whole Bible as well.

If we assume that God not only exists but also could reveal Himself to man even in a book, and that the apostles could be so used to either produce or help produce the book called the New Testament (and the Gospels in particular, since that is our specific point of discussion) then the existence of our Bible is not too surprising. The fact is that nothing known to or by man can deny these possibilities. The existence of the Bible rather affirms the fact that God does exist, and has revealed Himself. Now it is also past denying that God could not have used men like the apostles Matthew and John, and companions to the apostles, Mark and Luke, to write four books. Approaching the four books, as being at least possible productions by this means, we note that the apostles were promised guidance in not only what they had been taught and experienced but also in regard to things they yet knew not, Jn. 16:7-14 as an example. Who can deny absolutely that God kept His promise? Nothing is impossible with God, and such guidance is entirely possible. The books are prime evidence that God did do so.

But some will say, how account for the wide disparity between the accounts, or the parallels, even word for word at times? We answer, Is anything too hard for God? We can not account for the divine/human relationship of Jesus either, but if God is, such a relationship is entirely possible. What is so hard about also assuming that the Gospel records were products of a divine/human relationship? If Jesus is possible, why not the four accounts of

His life? One fact is not more difficult than the other! Stated differently, we assume that Jesus was divine and human at the same time, and that the four accounts of that God/man are just what they appear to be: products of two inspired apostles and two inspired men who were companions to apostles.

There is no one who can absolutely deny that such possibility can exist. Finite man can not establish an absolute of any kind. Even that statement, which is in the form of an absolute, can only be made in relationship to God Who is an absolute. Thus the statement about man's limitation is but an obvious deduction from recognition of our limited nature and relationship to God, the infinite being. It is only when men in unbelief, under such guises and philosophies as rationalism and evolution, assume that they are "God" that problems arise.

Do not conclude that the argument is for man to be naive—it is just an argument to show that scholars who argue that the Gospels can not be what they appear to have assumed what they can not prove. One may hold any position in regard to the four accounts that is desired, but by the same token, no one can establish beyond a shadow of a doubt that the four accounts can not be what they appear to be.

The reason for the above discussion is this: there is evidence within the four accounts that is difficult to understand. Yet there is no statement within any of the books, nor none in early writings, that indicates any of the writers used the others for information. We are not categorically denying that such may have happened, but it is an assumption quite without a firm basis. Luke mentions previous accounts, 1:1-4, but certainly does not state that he used any of them. (By the way, some current advocates of form criticism and redaction criticism argue that the early church produced basically what we have

in the Gospels. Hence they affirm that the Christ presented in the accounts was produced by the church, and deny that we can even know much if anything about the real Jesus. But Luke's prologue denies that: he says he got (?) his material from those who were eyewitnesses. Thus the church did not produce what Luke wrote. The only reason that some men argue for the Gospels being products of the church is 1) because they have accepted the premise of evolution and 2) it gets them free from an authoritative directive from God.) On the supposition that the apostles Matthew and John were the men who wrote the books with their names, it is a bit ridiculous to affirm that they needed sources to write what they themselves experienced. If the inspiration Jesus promised them actually happened, then they did not need any sources, since God could have miraculously revealed to them what they did not know themselves. In effect, the same is true for Mark and Luke: if inspiration from God be possible, then their accounts are possible, without any use of sources, all negations of this fact notwithstanding. We but note that the early church which included many inspired men accepted the four accounts in just this way. We heartily concur. (What seems to escape some, not all, scholars, is that if they make the Gospels products of the church, written late in the first or second centuries, then we have no inspired accounts of Jesus' life at all! We then would be adrift with no real hope at all.) It seems to us that if this position be correct, we have nothing to lose and everything to gain. If we deny the position that the Gospels are true products of God through men, and the denial is valid, we have no hope anyway. We may as well live in "confident despair." However, if the four accounts are from God and thus true, and we deny such and live that way, we gain nothing and lose all. The better choice in every way is to accept them as God's

love letters to men, and joyfully live in that light. To this end we so dedicate all we are and hope to be.

The above discussion is about three things: presuppositions, scholarship and faith. No one approaches the study of the Gospels without some kind of idea as to how they came to be. Even the attempt to approach them with an "open" mind expresses a presupposition that such is the correct way to do so. With respect to scholarship and faith, the two are certainly not antagonistic to one another, necessarily, nor are they synonymous, necessarily. One could be neither, either or both (or even varying degrees of both). This book is written from the point of view that 1) God is, 2) God was revealed through the divine/human personality known as Jesus of Nazareth, 3) His life was made known at least partially through the Bible, and more completely through the Four Gospels, and 4) which books in the original autographs were products of inspiration from God by means of human writers.

The following introductions to the four accounts are both too long and too short. Much more could have been said, much less, too. Hence, the problem always of what to write. We have added a list of books that will be helpful, some in one way, some in another. The vast amount of material available on the Four Gospels would take several good-sized books just to list. What we have attempted to do is give a selection ranging from one theological pole to another, since all are in some way useful, if only to give opposing viewpoints. Listing obviously does not mean endorsement of views expressed within the books.

MATTHEW LEVI, THE TAX-COLLECTOR, AND HIS BOOK

The Man Himself

Called by Jesus from an active life Mt. 9:9, he identifies himself as a tax-collector, 10:3. His place of business was Capernaum, a city at the cross-roads of commerce, from the far eastern countries, from Europe and Africa, as well as a commercial fishing city. From such a background, he probably knew several languages, and was acquainted with various schools of thought. Doubtless he was hated by most fellow Jews, as can be seen in Mt. 21:32; Luke 15:1-2.

He is mentioned very little in the Gospels, once in Acts 1:13, and not at all in the rest of the N.T. He is identified as Levi the son of Alphaeus by Mark, 2:14, and Levi by Luke, 5:27, in their accounts of his call to discipleship, though they later identify him as Matthew, Mk. 3, Lk. 6.

He was not the only apostle or Christian to have more than one name. Consider the following among the disciples of Christ:

Simon-Peter	Judas-Barsabas
Thaddaeus-Judas of James	Saul-Paul
John-Mark	Bartholomew-Nathanael
Joseph-Barnabas	Thomas-Twin
Simon-Niger	Joseph-Barsabbas-Justus
Jesus-Justus	

Early church testimony was unanimous for Matthew Levi being the author of the Gospel bearing his name. He is not identified as the author by name in the book, but we would hardly expect the early church to discard so many books with author's names in them that claimed to be something while accepting an anonymous book with-

out some very good reasons. The early readers were expected to receive it as authoritative; we assume, and did so. (It would hardly be likely that the hated tax-collector would be associated with a book if it were not so.) The probable reason is that an apostle was the author, and the book had such authority behind it. Interestingly enough, Levi's book was quoted more by the early church than all the other Gospels put together. It was not until the third century when the matter of Christ's nature became a major issue that John's Gospel became well-used.

Matthew's use of the Old Testament (over 60 quotes or allusions) helps provide a connecting link between the Old Testament. Note that the first great discourse, chs. 5-7, is about Jesus' relationship to the law. He often used the Greek translation of the Old Testament called the Septuagint (LXX) in his quotes. The Epistle of Barnabas (ca. 130) first uses the expression, "It is written" while quoting Matthew 20:16 and 22:14.

Though not always chronologically exact, yet the method of presentation is orderly, showing Matthew's thought processes, which doubtless were helpful in making him a fit person to be a tax-collector.

Though he does not mention himself as the author of his book outright, the incidental remark in 9:10 about Jesus sitting in "the" house probably shows it was Matthew's house in which the feast occurred. His notice of the word *nomisma* (state coin) in 22:19 may well reflect his background in money matters. If it was possible for an apostle to write a book, and for God to work through Matthew the apostle to do so, then we should not be surprised if such occurred, and the early church to so recognize it.

His Book

The book is often called the "ecclesiastical gospel"

because of the emphasis upon the church/kingdom. This Gospel is the only one to use the word "church," 16:18, 18:17.

Jesus as the fulfillment of God's promise in the Old Testament is the theme of this book. It begins by tracing the lineage back to David and Abraham, both of whom had received promises from God. The genealogy (though it includes two Gentiles in it) shows the Jewish reader that Jesus was of the proper lineage legally. Yet this polemic purpose, seen in the O.T. quotes and the genealogy, does not exclude that idea that the whole world was to be in on God's blessings. The Gentile wise men, Galilee of the Gentiles (4:15), the faith of the Roman Centurion (8:10), the ministry to bring the Gentiles hope (12:18-21), the "other nation" in 21:33-44, and a universal mission (ch. 28), all reflect a Messiah-king for every road.

Early church men such as Clement of Rome (ca. 30-100), Ignatius, bishop of Antioch (martyred ca. 116), Polycarp, bishop of Smyrna (martyred 155), Papias, bishop of Hierapolis (ca. 80-155), Tatian (born ca. 120), Clement of Alexandria (ca. 155-215), and Origen of Alexandria (ca. 185-254) all knew and used Matthew, with no dissenting voice against his authorship. The book was included in the Old Latin and Old Syriac versions (both about 150 A.D.) which shows its importance. Sometimes it was placed first in early Greek Manuscripts followed by John (then Mark and Luke) since both were written by apostles, though Matthew wrote before John. The Diatessaron by Tatian (ca. 170) uses it and the Muratorian canon (ca. 180) which lists all but four books (I Peter, II Peter, James and Hebrews) in our N.T. has the first part lost, but begins with Luke, then John. It obviously gives evidence that Matthew and Mark had been mentioned as the first two in the list. Hence, though some modern scholars either assert that Matthew's book was but an

enlargement of Mark, that Matthew did not write it, or both, they are quite at variance with the rest of the church. We conclude that their unjustified presuppositions have caused them to be out of step rather than those mentioned above who assert that Matthew was written by Matthew Levi, the apostle. Obviously the early church, some of whom gave their lives for their sacred books, were more than a little interested in the quality of the books they claimed as the Bible. If the book of Matthew had apostolic authority as commonly believed, then it would be held in much different light than many other books circulating around which had no such backing, though claiming it. The early church was certainly more interested in who authored a book than who provided some of the material in it (as is the case with Mark and Peter).

The book was apparently written some years after the events if 27:7-8 and 28:15 are any indication. However, the lack of any stated fulfillment of the predicted fall of Jerusalem in ch. 24 probably indicates the book was written prior to A.D. 70. Whether the remarks of Luke in 1:1-4 imply that Luke had access to books that were insufficient in some way (thus seemingly not speaking about Matthew or Mark's Gospels) is debatable. Perhaps Luke did not know of Matthew or Mark's Gospels, even though they were in circulation. If the position taken by some be true, that Luke implies all the accounts he knew were in some way questionable, then Matthew's Gospel was written sometime in the period A.D. 60-70. However, as stated above, Matthew and Mark's Gospels could possibly have been in circulation elsewhere, or not adequate for what Luke needed (or maybe God directed Luke to write his Gospel anyway!). Thus we really do not know how long before A.D. 70 the gospel was written. Some guess as early as A.D. 45-50. Irenaeus remarked that Matthew wrote his Gospel while Peter and Paul were yet

preaching. Clement of Alexandria remarks that Matthew and Luke wrote first, ahead of Mark and John. However, some dispute this statement. The lack of explanations of Jewish customs probably points to a predominantly Jewish audience and/or a time of writing before the forced dispersion under Titus in A.D. 70.

Matthew's book combines events and teaching to a considerable extent (much like John). The apostle records six great discourses: the Sermon on Mount (5-7), missionary instructions (10), lakeside parables (13), church polity (18), the condemnation of Jewish hierarchy (23), the discussion of Jerusalem's end and His second coming (24, 25), all built around events.

It is sometimes referred to as the Gospel of the king, since it traces Jesus' lineage to David, relates the search for the one born king of the Jews, refers to Jesus as "Son of David" nine times, (1:1, 9:27; 12:23; 15:22; 20:30-31; 21:9, 15; 22:42), presents Jesus as king of every nation, 25:31, and has Jesus responding affirmatively to Pilate's question, "Are you the King of the Jews" in 27:11. Yet Jesus was more than an earthly king, for He was "God with us" (1:23) "always" (28:20), Who had come to save all His people from their sins (1:21), for the field is the world (13:38), and to do so for all time (even in the highways and byways, 22:9) through the church, His body, which not even death, and him (Satan) who has the power of death (Heb. 2:14) can destroy, 16:18.

Some have compared Matthew with Mark and Luke and there are events common to all (see the previous discussion of the Gospels). Yet Matthew has some 300 verses that are peculiar to his Gospel, showing that he is quite independent of anyone's book. The visit of the angel to Joseph, the visit of the wise men, the Sermon on the Mount, the sending out of the 12, the parable of the laborers in the vineyard and the material in ch. 25 are examples of

such material. The book has 10 parables and 3 miracles contained in no other book (such as the tares, the hid treasure, draw net, or the healing of the 2 blind men and the dumb demoniac).

Matthew's use of "kingdom of Heaven" (33 times) versus "kingdom of God" (4 times, 12:28; 19:24; 21:31, 43) is interesting as one compares the parallels in Mark and Luke's Gospels. Mark and Luke both have the "kingdom of God" a great number of times (over 30 times in Luke) and the expression "kingdom of heaven" not once! The idea of righteous/righteousness occurs more times in Matthew than all the other three combined. The idea of Jesus' humanity certainly is shown by the occurrence of the expression "Son of man" over 30 times. (This expression occurs 81 times in the four Gospels, and some over 40 times are distinct occurrences.) Jesus uses it much of Himself, perhaps to emphasize His human nature. Yet He would and did on many occasions likewise assert His deity, as in the Sermon on the Mount or to Caiaphas, 27:63-64. By the way, some present scholars do not think that Jesus asserted He was the Son of God to Caiaphas (or to Pilate later). However, Jesus was under oath and did not refuse to tell the truth about Himself ever. Thus Caiaphas so understood Jesus to affirm that He was the Son of God and considered it blasphemy, tearing his garment. It was for this assertion about His identity (see John 19:7) that Jesus died! And for the same reason did Matthew the apostle write: to show that Jesus of Nazareth was the Christ, the Son of the Living God.

OUTLINE FOR MATTHEW

1:1—2:23	Introduction and birth
3:1—4:11	John's preaching, Jesus' baptism and temptation

GOSPELS INTRODUCTION

4:12—13:58	Jesus in Galilee
14:1—20:34	Journeys with the Twelve
21:1—25:46	Teaching in Jerusalem
26:1—27:66	Passion and death
28:1-20	Resurrection

JOHN MARK, THE MAN AND HIS BOOK

The Man Himself

John Mark appears by name some eight times in the New Testament. He first appears by name in Acts 12:12, associated with his mother Mary, whose home was a meeting place for the saints and to which Peter went when he was miraculously released from prison. Thus, at first mention he is in contact with apostles, and others including James the brother of the Lord. He had access to many who could tell him about the Lord, his life and ministry.

He next appears with Barnabas (who was related to him) and Paul in Acts 12:25, where he accompanies them from Jerusalem to Syrian Antioch. Then in Acts 13:13 he, having left with Silas and Paul on their journey, left them to return to Jerusalem. He apparently went back to Antioch of Syria, because in Acts 16:37 he is there when Paul and Barnabas disagree over him. He departs to Cyprus with Barnabas for evangelistic work.

Apparently the adverseness Paul felt towards Mark was of a temporary nature, because Paul mentions him as being in Rome with him, Col. 4:10. This reference informs us that he was some relation to Barnabas. The Greek term *anepsios* meant cousin in Paul's day. It came into Latin as *nepos*, whence our English word *nephew*. However, it did not mean *nephew* in Paul's day, but a

more distant relationship, best expressed by our English word cousin. (Remember—the King James version which uses “sister’s son,” i.e. ‘nephew’ was translated almost 1600 years after Paul wrote Colossians and the men who did the translating were somewhat guided by the Latin Vulgate as well as the Greek text they were using.)

We next meet John Mark in II Timothy 4:11 where Timothy is instructed to bring Mark to Rome(?) with him because he is profitable to Paul. The last reference to Mark is in I Peter 5:13, where he is called the son of Peter. Probably the word “son” means the same as it does in II Cor. 6:18, etc.

The man John Mark had much opportunity to know the facts about Jesus, not only from personal experience (does Mark 14:51-52 refer to the author of the book? It easily could, since the Garden of Gethsemane was nigh to Jerusalem, and it would not be unlike a young man like Mark to be around the disciples. In fact, the text in Mark 14:17 may indicate an eyewitness point-of-view.) but also from others who knew, either by personal experience, by revelation from God, or both. We think there is very good reason to believe that Mark could write his book without necessarily copying from anyone. He certainly did not write it in a vacuum.

In addition to his own opportunities, early church fathers indicate that he accompanied Peter in later years (as I Peter 5 indicates) and the Gospel was a reflection of Peter’s preaching. Papias as quoted by Eusebius (ca. 265-340) so wrote. Irenaeus, Clement of Alexandria and Origen all so affirm. It is possible that they all repeat the information that Papias gave. It is also quite possible, and much more likely, that they were just as interested in who wrote the book as we are, and upon investigation into the matter gave their conclusions. There is the evidence of Tatian’s Diatessaron (a harmony of the four

GOSPELS INTRODUCTION

Gospels) which includes Mark's book as being equal in inspiration with the others, as well as the Old Latin and the Old Syriac versions which include the book.

Thus the testimony of the early church is that the book was produced by John Mark, the companion of Paul, Silas, Barnabas and Peter, and that the book was to be received as equal to the other three as far as inspiration goes. Surely if Mark were not the author, someone in the early church would have known who the true author was, and the proper person given the credit for it. Someone as insignificant as Mark when compared to the apostles would hardly have been ascribed the authorship of the book if it were not so.

His Book

Mark's book is many things—easily translated in comparison with the others, with rapidity of movement and vividness in detail—yet long discourses as in chs. 4, 7, 9, 10, 12 and 13. The Greek word for someone in a hurry, or describing rapidity of action is *euthus*, which occurs some 42 times in Mark (only 7 in Matthew) and 14 of those times in respect to Jesus.

One would think that Jesus was moving all the time, yet if so, much teaching went on, because the words for teach and teaching, *didaskō* and *didachē*, occur more frequently in this book than in any other Gospel. The miracles were often used for the purpose of instruction, as in 5:19 and 11:21-23. The Gospel contains some 19 miracles (though many more are done, 1:34, 39; 3:9, etc.) and probably only 7 parables. Most of these can be found in either Matthew or Luke, but the following sections are either only in Mark or basically there: 4:26-29; 7:32-37; 8:22-26; 9:42-50; 13:33-37 and 14:51-52. In addition, many incidents are "touched-up" as the healing of

Jairus' daughter and the woman who was healed on the way to the house of Jairus (ch. 5) or the account of Bartimaeus in ch. 10, or the cursing of the fig tree in ch. 11. To add color and the feeling of motion, the Greek text contains some 141 "historic presents" (which are hard to translate into English).

Some have thought that Mark was written primarily for Gentiles, especially Romans, but there are some 19 formal quotations from the O.T. plus many more allusions (There are some 160 quotes or allusions in the Gospels) to it. The earliest testimony links the author and his book to Rome (*The Shepherd of Hermas* and *I Clement* may give some evidence for this idea, though disputable) but whether this is borne out by the evidence is certainly questionable. If so, there were still Jews in Rome as well as Gentiles, and the Gospel certainly was meant for everyone, and so realized by the time this book was written. Actually, no one really knows where any of the Gospels were written. The only date we can give with certainty for this Gospel is A.D. 70. Jesus predicted the fall of Jerusalem (ch. 13) and we assume that had it occurred before the book was written, Mark would have noted it. Clement of Alexandria as quoted by Eusebius stated that the earliest books written were those concerned with the genealogies (Matthew and Luke) and then Mark wrote for Peter. We know nothing actually contrary to this idea.

Mark's book often presents Jesus as in the midst of people, as a man serving others (Son of man occurs 14 times) though that servant is variously represented as a king, as God (note the mission of John in 1:1-3, and as Son of the Blessed, 14:61-62) or as a man, serving God—even to the death on the cross (some 40% of Mark is concerned with the events of the last week) accursed of God, Deut. 21:23, deserted by God, Isa. 59:1-2, having been mistreated, misunderstood, mocked, and betrayed by

GOSPELS INTRODUCTION

His erstwhile friends. Perhaps Jesus' statement in 10:45 is the key: "I came not to be served but to serve, and give My life as a ransom for many."

OUTLINE OF MARK

1:1-13	Introduction
1:14—9:50	Jesus in Galilee
10:1-52	Journeys with Twelve
11:1—13:37	Teaching in Jerusalem
14:1—15:47	Passion and Death
16:1-8	Resurrection

LUKE, THE BELOVED PHYSICIAN, AND HIS BOOK

The Man

Pioneer church historian—premier traveling companion—physician of body and soul: such is our Luke. God certainly picked His men aright, and Dr. Luke is no exception. Author of at least $\frac{1}{4}$ of our whole New Testament (based on the total amount of material rather than the number of books), he traced "all things accurately" from Adam through Abraham to Christ, on to Pentecost and the first 30 odd years of church history. Luke, we salute you for a job well-done!

We can not separate Dr. Luke's Gospel from the book of Acts. To discuss the author of one is to do the same for the other. Indeed, he meant for us to so understand. In a comparison with a contemporary of Luke, Josephus the Jewish historian, we can see that Luke knew how historians wrote in his day, and so wrote his two-volume history. Josephus wrote a two-volume set called *Concerning the High Antiquity of the Jews* (known as *Against Apion* since Jerome's time, ca. 340-420) divided into Book

I and Book II. These two were intended by Josephus to be taken as one work, not two different ones. Luke and Acts, as we know them, were just as obviously meant to be such. The introduction to the Gospel is not repeated in Acts, but the connection is plainly made, being written to Theophilus by his friend (unnamed but known to us as) Luke. It is true to say, however, that the Gospels are unique, and deal with a unique personage, Jesus. Hence, the particular method of presentation may be as unique as the One of Whom they write.

The first volume is not the account of an eyewitness, so Luke had to obtain his material from eyewitnesses (see Acts 1:21-22) and ministers (the two terms are perhaps descriptive of the same person, at least at times) of the word. However, mid-way through the account of the early church activity, Luke becomes part and parcel of the chronicle he is producing. Thus he writes for all to read.

He is mentioned in Paul's letters as his fellow-worker, and beloved by Paul. He was probably a Gentile by birth, Col. 4:10-14, though where he was born is unknown. He went to Rome with Paul as he himself recorded in Acts 27, 28. Apparently others went with them, or met them in Rome, for Paul mentions others in Col. 4 and Philemon 23-24. But Paul's last letter shows all had departed, II Tim. 4:11, and Luke alone is with him. Some suppose that Paul's bodily affliction (II Cor. 12:7-9; Gal. 4:15) required the attendance of such as Luke, but that is unknown. Perhaps the willingness of Luke to practice the healing of bodies in return for financial help to be shared with Paul was the reason for Luke's presence.

His books are well-knit and represent painstaking care. For instance, in the healing of the man with the withered hand, Luke notes it was the *right* hand, ch. 6. He notes that the demonized man in the tombs had worn *no clothes*

GOSPELS INTRODUCTION

for a long time. He is often acclaimed as the best writer in the N.T., from the viewpoints of style, grammar and word usage. Though the assertion can not be made that his books assuredly are products of a physician, they do display a careful touch for accuracy and necessary detail, products of such a person with an education like he apparently possessed.

(There is an interesting textual addition to Acts 11:28. Codex D [known as Bezae] and a few other MSS have an addition to the beginning of that verse that would read "and we having assembled." Then the account about Agabus would follow. If this reading is genuine, Luke's presence in Antioch of Syria would be evident, and a parallel to the "we" sections beginning in ch. 16. Acts 6:5 regarding Nicolaus a proselyte of Antioch is then of interest. The incidents in chs. 11; 12:25; 13:1ff., etc. may be first-hand. If Antioch be Luke's original home, he may have attended the famous medical school of Aesculapius at nearby Algae. However, this is strictly conjectural.)

He did not intend that his work necessarily supplant all others (we do not really know if he were aware of Matthew and Mark—but they may not even have been written when he wrote his book—or if so, that Luke knew about them) but rather supplement others, especially to the end that Theophilus (and any "lover of God") might rest assured in faith that God had invaded the planet earth in the person of Jesus of Nazareth, the Christ of God.

He was sure of his facts, and accurate in their presentation. 2:1-7 used to be considered as containing more historical errors than any comparable passage of history. Time and research, especially in the papyri finds from Egypt, have proved Luke to be right rather than his accusers. Sir William Ramsay set out to Asia Minor to

prove the N.T. was not believable, but like many others who give honest effort, he had to change his mind. Time after time, the N.T. was correct, and he ended his life defending the book, and considered Luke the greatest of all historians of his day, not excluding Thucydides. His several books, including *The Bearing of Recent Discovery on the Trustworthiness of the N.T.* and *Was Jesus Born at Bethlehem* were written with this viewpoint. A. T. Robertson's book, *Luke the Historian in the Light of Research* is also good in this area.

The stay with Paul (Acts 23-26) in A.D. 58-60 at Caesarea gave Luke plenty of time to research the information (perhaps even from James the Lord's brother) necessary to the writing of the Gospel. The companionship with Paul could have provided the inspiration Paul the apostle could give necessary to making the book what God wanted it to be. The earliest patristic testimony to Luke's authorship is probably Irenaeus, who remarks that Luke wrote the Gospel as proclaimed by Paul. The Muratorian Canon contains the same general assertion as to the author of the book. In fact, as with the other three Gospels, the early church's testimony is that Luke wrote the book. Tatian's Diatessaron, Tertullian (ca. 160-220) and Eusebius all agree with Irenaeus. Marcion (ca. 140) the gnostic did not question Luke's authorship, but rather deleted some sections he did not like. Celsus (ca. 178) attacks it as a product of Luke. Evidence for its usage is very early as can be seen in the chart of patristic quotes.

As mentioned before, the obvious ties between Luke 1:1-4 and Acts 1:1 assert the same writer and recipient. The discussion of who is meant by "we" in Acts 16:10-17; 20:5-15; 21:1-18 and 27:1-28 will rather clearly identify the "I" in Acts 1:1 as a companion of Paul.

Since the author went to Rome with Paul, it is likely that Paul mentions him in the prison epistles. The people

GOSPELS INTRODUCTION

mentioned in the "we" sections of Acts are ruled out obviously, which are Aristarchus, Gaius, Secundus, Silas, Sopater, Timothy, Tychicus, and Trophimus. Those mentioned by Paul in either Ephesians, Philippians, Colossians, or Philemon are: Demas, Epaphras, Epaphroditus, Jesus Justus, Luke and (John) Mark. Consider the following then:

- a. Epaphras and Epaphroditus did not make the sea voyage, therefore are not the author, as they could not be eyewitness to those events.
- b. Mark is mentioned in Acts, but in third person.
- c. Demas, Jesus Justus and Luke are left. Demas is rather unlikely and does not seem to have been with Paul in Acts, nor Jesus Justus, and neither have any tradition backing them for the author. Conversely, early testimony is solidly for Luke. In view of the fact that early patristic writers made much of apostolic authorship, it is significant that Mark and Luke are acclaimed as authors of their respective books.

The occasion for the book was to help Theophilus in his faith. Whether the Greek term *katechethēs* means Theophilus had received some instruction but needed more, or what instruction he had received was doubtful is unsure. Luke endeavored to "set the record straight" in what he wrote. He tried to write "orderly" in his book. Some take this word to mean chronologically, others to mean in good order and continuous within itself. Both seem to be pretty much true. It was to be a credible record of proclamation about Jesus through His chosen followers, as seen in Luke 24:48 and Acts 1:8.

The dedication of the book to *kratistē* (most excellent) Theophilus is interesting. The term occurs again in Acts 23:26; 24:2 and 26:25. Josephus dedicated his

Book II (Against Apion) to kratistē Ephroditus. It rather appears to be a word used in addressing officials, though we know nothing of Theophilus, nor what relationship existed between Luke and Theophilus.

The time for the book is preceding Acts. We assume (though other positions could be possible) that Acts 28 was the last written by Luke, and written about A.D. 63. It seems rather incredible that Luke would close the book without giving an account of Paul's fate, though such is possible. Hence we assume a date of A.D. 55-60 for the Gospel.

Luke's book is the longest book in the New Testament and actually contains more about Jesus' life than any of the other gospels. Some of the things it contains are:

1. There is a cosmopolitan flavor about the book. For instance, all classes of people are mentioned, such as men, women, rich, poor, Jew, Samaritan, Gentile, good, bad, etc. Too, Jesus is presented as being a "redeemer," 1:68, so universally needed (often Luke used the Greek word *dei* 'it is necessary' to speak of Jesus) by everyone, 2:38; 3:6; 21:28, 35; 24:21; Acts 1:8, etc. Luke traces the lineage of Jesus back to Adam, the father of us all. It is noteworthy that Luke explains things pertaining to Palestine, but does not do so for the Greco-Roman world.
2. The special emphasis upon women and their place in the kingdom, chs. 1, 2, 8:2-3; 21:1-4, etc. The five healing miracles that are peculiar to Luke (Some 35 miracles are described in detail in the Gospels, and Luke gives 20. Among those are 26 miracles of healing and Luke has 16 of them.) reflect his particular interest. These five were characterized by being chronic or incurable. Note

GOSPELS INTRODUCTION

the widow of Nain's son, ch. 7, the women with the curvature of the spine, ch. 13, the man with the dropsy, ch. 14, the lepers, ch. 17, and the healing of Malchus' ear, ch. 22. He records more private prayers by Jesus than any other Gospel, as in 3:21; 5:16; 6:12; 9:18; 10:21; 11:1; 22:32; 23:34. Individuals are often highlighted, as Zechariah, Simeon, the women in Simon's house, Mary and Martha, the prodigal son, the unjust judge, Cleopas and his companion, etc. The special section from 9:51—18:14, plus 19:1-28 are only in Luke. Some have estimated that over 50% of Luke's material is not in the other Gospels.

3. Points of godly living or doctrine receive their due, as Luke contains more of praise and adoration than any other book, such as 1:14, 44, 46ff., 64, 68ff.; 2:14; 29-30; 6:23; 15:23-32; 24:52; etc. The expressions "praising God," or "blessing God" are almost all in Luke's Gospel. Forgiveness, as in 7:36-50; 17:1-10; 18:9-14; etc.; authority, as in 1:20, 37; 2:49-51; 4:14; 7:1-10; 13:12; 17:14; 19:9; etc.; and the Holy Spirit, as in 1:35, 41, 67; 2:25-27; 3:22; 4:1, 14; 11:13; 12:12; 24:49 with Acts 1:5-8; etc. There is even considerable reference to the human spirit, which may reflect Luke's accurate analysis of the human body.

He has some 20 miracles, of which 6 are peculiar to him. There are over 30 parables in the Gospels, and Luke has some 19 of them.

Some have asserted that Luke's theological position was so different than Paul's as to militate against Luke's authorship. But there is certainly nothing that causes us to maintain that traveling companions must share the same viewpoint on things, much less express them in the same

ways, even if they do. However, a careful perusal of Luke-Acts as compared with Romans-Galatians will show this: both Luke and Paul wrote of and ministered a universal gospel predicating salvation for all the on the common ground of faith in Jesus Christ, and that the *new covenant was not an addition to the Law*, but a whole new relationship with God, whose children are not in any way obligated to keep the law of Moses, but are free in Christ. Certainly Luke's consuming directive was to declare the truth about Him Who came "to seek and save the lost, . . . the horn of salvation from the house of David, God's beloved Son in Whom He was well pleased."

OUTLINE TO LUKE

1:1-4	Prologue
1:5—2:80	Birth and childhood of John and Jesus
3:1—4:13	John's preaching, Jesus' baptism and temptations
4:14—9:50	Jesus in Galilee
9:51—19:27	Journeys with Twelve, ministry in Perea
19:28—21:38	Teaching in Jerusalem
22:1—23:56	Passion and Death
24:1—53	Resurrection and ascension

JOHN, THE "SON OF THUNDER" "WHOM JESUS LOVED" AND HIS BOOK

The Man

To love-or not to love: that is John's question. This man, as His Master, is not described physically in the N. T. Yet, one certainly comes to a distinct mental picture of

GOSPELS INTRODUCTION

the author as well as the One of Whom he wrote when reading the Gospel according to John. He did not write to talk about himself, his family or his friends, for he defers to being anonymous, and does not name his family. His friends are named, but not praised or extolled. His Master, even Jesus, is the "lovely one" Who came that life abundant might be an integral part of every life.

Perhaps we know more about John than any of the other Gospel writers. His father was Zebedee, his mother Salome. James was his older(?) brother. His uncle and aunt were Joseph and Mary (which may help explain the request by Salome in Mt. 20:20), his cousins include Jesus as well as His brothers and sisters. He was a disciple of Jesus' cousin, John the Immerser, along with James. Two of his close friends, Peter and Andrew, were also John's disciples as well as fellow-fishermen. He was in some way friends (He also knew the man who had "ear trouble" because of Peter's sword, Malchus) with Caiaphas (or Annas) and thus could get in the court yard where Jesus was taken, and also get Peter in. His father, a resident of Bethsaida by the Sea of Galilee, was financially able to have hired help, and thus allow his two sons, James and John, to follow Jesus rather than help in the fishing business, plus the fact that his mother, Salome, could be one of those who supported (her sons, and) Jesus in His ministry, Lk. 8:2-3.

Like multitudes of others, John was transformed by Jesus. So much is this true that after having listened, followed, and preached about Christ for some 50 years, one reading his Gospel can hardly discern where Jesus leaves off speaking and John starts writing, as in ch. 3. Doubtless John did not have this sort of character at the beginning of life, as Jesus' description of him and his brother ("sons of thunder") implies. But is not the message of Jesus to become such a part of a person's life

that it could be said, "For (a man) to live is Christ" and that such a person has grown into the "measure of the stature of Christ's fullness?" Do not like minds produce like characters (Phil. 2:5)?

Note how John's book presents the personality of Jesus as being so like God the Father that it could truly be said that Jesus and the Father were one, 10:30. Jesus prayed for "oneness" in ch. 17, John records. Thus he himself so believed in Christ that Christ could live in him. It is said that in his last days, brethren would carry John to the assemblies, where he would often repeat, "Little children, love one another." Does that reverberate in your ears as a true echo of His Master?

John intended to be for his readers what he was for his brother: a connecting link with Jesus. He never implies that the other Gospels were not as useful as his, but only that Jesus had so many facets that another presentation of His life was useful. One could hardly plumb the depths of God's personality (or for that matter put down in writing the total truth about a human personality)—even if one filled the world with books! How glad we are, though, that the "disciple whom Jesus loved" gave us his book.

His Book

The Gospel certainly is unique in comparison with the Synoptics, not only for that which is omitted, but that included. Yet, its overall framework is the same as the others, and Jesus is yet presented as a divine/human personality. That it is the work of the apostle John is the testimony of the early church fathers. We note the wide difference between it and the Synoptics. It seems to us that if the Gospel had not had apostolic authority, its acceptance would have been slow if at all. But the

opposite is true. In fact, the earliest copies of any Gospel we have are those of John's! The Robert's Fragment, better known as the John Rylands 457, containing ch. 18:31-33 (recto) and 18:37-38 (verso) dates ca. 125-150. Portions of ch. 5 are alluded to in the Egerton Papyrus 2, also dated ca. 130-150. The former piece of papyrus is from Egypt which shows the wide usage of John at an early date. Ignatius, bishop of Antioch (martyred ca. 116), Polycarp, bishop of Smyrna (ca. 69-155), Justin (Martyr, ca. 100-165), Papias, bishop of Hierapolis (ca. 80-155), Tatian (born ca. 120), Theophilus, bishop of Antioch, (ca. 115-108), all knew and quoted the Gospel. Theophilus is the first to name John as the author. Irenaeus (ca. 140-203) accepted it as John's work and published at Ephesus, but remarked that some people did not do so on the basis that it painted a false picture of Christ, since what Christ promised (especially about the work of the Holy Spirit) could not be so. Gaius, an elder at Rome, refused the book on the same basis. Clement of Alexandria (ca. 155-215) and Origen of Alexandria (ca. 185-254) both knew and accepted the authorship of John. It was in the Old Latin and Old Syriac (both ca. 150) and the Muratorian Canon (ca. 170, which is so called because an Italian named Muratori found it in the Ambrosian Library at Milan in 1740). The external evidence is good, as is also the case with the other three gospels.

The evidence internally depends upon the identification of the "disciple whom Jesus loved." It is likely John since the book though anonymous was accepted almost universally as John's. The author evidently knew much about Jewish customs, doctrine and thought, as seen in 2:6, 13ff.; 4:7ff., 27; 5:10; 7:21-23, 37 and 8:12; 9:2ff.; 11:49ff.; 18:13ff.; 19:31-42; etc. The land of Palestine is familiar and events are given from an eyewitness point

of view, as in 1:28 and 12:1; 2:1, 6; 3:23; 4:5, 21; 6:1, 19; 11:54; 21:8, 11; etc.

The author is a friend of Peter's apparently, since they are often together (did a "son of thunder" and an "impulsive brash" fisherman make a pair?) as in 13:23-24; 20:2-9; 21:7. The person who best fits this idea is John, since James is either mentioned otherwise or dead. Note Mk. 5:37; Lk. 22:8; Acts 3:1, 11; 8:14; Gal. 2:9. Jesus gave the keeping of His mother to this disciple, 19:26, and John certainly is a logical person here. The author mentions the forerunner of Jesus only as John. The Synoptics call this man John the Immerser, and also mention another John who was prominent in Jesus' ministry, identifying the second man as Jesus' disciple. Thus the obvious reason for not identifying Jesus' forerunner in the fourth Gospel as John the Immerser is that the other man named John is doing the writing, which leaves no need to further identify the other man named John. The "we" in 1:14, and the oblique reference in 1:41 probably connects John and James, Peter and Andrew. The unnamed disciples in 1:35ff. are probably Andrew and John, and the account reads like a recollection of an eyewitness, which most naturally is John, son of Zebedee.

The text of 21:2ff. narrows the problems of authorship down to the two sons of Zebedee and two unnamed disciples. Peter, Thomas, and Nathanael are all ruled out, since they are mentioned elsewhere in third person. The one who first recognizes Jesus so mentions the fact to Peter. Later, Peter turns and sees this same disciple following and asks about him. This relationship probably points again to Peter and John, making John the author. This is the testimony of the internal evidence and with which we concur.

As it is with the other Gospels, we do not really know when the book was written. Remarks like that of Irenaeus

mentioned above locate the place and time of writing at Ephesus when John was old. Though some take issue with Irenaeus because his testimony is for the authorship of John who wrote it at Ephesus after the other Gospels were written, it is passing strange that if it were not so, why the assertion of Irenaeus was accepted both in the Eastern and Western sectors of the church. Irenaeus was a pupil of Polycarp, who studied at the feet of John the apostle. It would be hard to find any better testimony than his.

The purpose of John's book is stated plainly in 20:30-31. Hence all that he wrote was selected for that express purpose. Much more could have been added, but by inspiration we have 21 chapters to help us find life in Jesus. (Incidentally, many argue that ch. 21 is a later addition by someone other than John, but there is not one shred of evidence for such assertion. The chapter is always with the rest as far back as evidence goes. Internally, it shows the same writer as the preceding 20 chapters. Thus, we assume John wrote ch. 21, though v. 24 may be the testimony of others to John's authorship. Perhaps the present tense of the verb "bears" affirms the author is very much alive.)

The omissions are many—John did not mention Jesus' birth, genealogy, or childhood, the Sermon on the Mount, the three tours of Galilee, the confession of Jesus' identity, the long section of events in Luke 9:51—19:14, the discussion in the temple during the last week, the long discourse in Mt. 24-25, the institution of the Lord's supper, or many of the resurrection appearances, or the ascension, just to name some. He did not use the word church or repentance, or the noun form of the word for faith (though the verb form occurs many times). He omitted parables (though allegories occur, as in 10:1ff. and 15:1ff.) entirely, unless 10:6 be referring to one

(The Greek term means a "wayside saying," something akin to a parable). He recorded only two miracles, the feeding of the 5,000 and Jesus walking on the water, found in the Synoptics, while having six peculiar to himself, excluding the resurrection. He apparently has events covering possibly 20 days (ch. 13:1—19:42, almost 1/3 of the book, cover only one 24 hour day, Jewish time). He included but little of Jesus' ministry outside of Judea, ch. 6 at Capernaum, and ch. 21 at the Sea of Galilee being the exceptions.

Inclusions are just as striking—and almost the whole book is in this category. Only twice (ch. 6, 12) does John harmonize with the Synoptics to any degree before the last week. Even much of the last week is not the same, as all of chs. 14-17 show. Yet, though John's portrait of Jesus be different, how many aspects of Jesus do we know? Who can delineate all the different facets of a divine/human personality? We heartily agree with both Paul in I Cor. 13:12 and John in I Jn. 3:1-3 in this respect—we finite creatures can only know in part.

Individual personalities are abundant in John, such as Nicodemus, the Samaritan woman, the lame man at the pool, the blind man in Jerusalem, Lazarus, Caiaphas, and Mary, sister of Martha.

Great contrasts or relationships such as light/darkness, life/death, Father/Son, truth/error, etc. appear. Vivid metaphors about Jesus, coupled with His "I am's" occur: I am He (the Messiah) 4:26; I am the bread of life 6:35; I am the light of the world 8:12; "I am" 8:58; I am the door of the sheep 10:7; I am the good shepherd 10:11; I am the resurrection and the life, 11:25; I am the way, the truth, the life 14:6; I am the true vine 15:1; etc.

The ideas of Jesus' deity are especially prominent, as seen in 1:1-18, 50-51; 3:31-36; 5:17-29; 14:8; 17:3, 24-

GOSPELS INTRODUCTION

25; etc. Yet John does not minimize His humanity, see 1:14; 4:6; 6:53-59; 15:20; 19:23-24, 28, 34; etc.

The concepts of to love, to believe, to see, to know and to speak are found in this Gospel. The idea of glory often is seen, and will be somewhat of an eye-opener to the reader who has not noticed its varied usage. Read 1:14; 2:11; 5:44; 7:18, 39; 11:4, 40; 12:28, 43; (the word "praise" translates the same Greek word) 13:31-32; 14:13; 15:8; 16:14; 17:1, 10, 22, 24.

Feasts of the Jews form major points in the Gospel. The sequence of Passover ch. 2, Passover ch. 5, Passover ch. 6, Tabernacles chs. 7-10:18, Dedication 10:19-39 and Passover ch. 13-20 keep the ministry of Jesus pretty well centered in Jerusalem or Judea in this Gospel, though ch. 6 only notes the nearness of a Passover. These feasts stretch the ministry of Jesus to over three years. Along with the Jewish feasts, notice how often Jesus is connected with the O.T., as in 1:11, 17; 2:13ff.; 3:1, 14; 4:22; 5:30-47; 6:30ff.; 8:56-58; etc.

John's Gospel is interesting to the Greek student for several reasons. Though the vocabulary and grammar are relatively easy, the obvious depth of meaning (seen even in the English) always challenges the reader. The Greek words *hoti*, (some 270 times), *hina* (about 140 times) *amēn*, and *palin* are frequent.

The work of the Holy Spirit is prominent, but often in distinctly new ways. Read 1:32-34; 3:34; 7:37-39; 14:16-17; 15:26; 16:7-14; 20:21-23.

While all of these ideas may be seen, and others like them, the personality of the "Lamb of God Who takes away the sin of the world," the eternal "I am" is the reason for the rest. Surely a sympathetic reading of this Gospel in its presentation of the incarnate Word will lead one to exclaim with Thomas about that Word: "My Lord and My God."

NEW TESTAMENT HISTORY: THE CHRIST

OUTLINE OF JOHN

1:1-18	Prologue
1:19—12:50	Public Ministry
13:1—17:26	Private Ministry
18:1—19:42	Passion and death
20:1—21:25	Resurrection

BOOKS FOR STUDY OF THE GOSPELS

Introductions

1. *Introduction to the New Testament*, Theissen, Eerdmans. The best one volume book. Does not accept primacy of Mark, etc. (1943)
2. *Introduction to the New Testament*, Harrison, Eerdmans. In some ways better than Theissen, but accepts primacy of Mark. (1964)
3. *New Testament Introduction, Gospels and Acts*, Guthrie, Inter-Varsity and Tyndale Press. One of a three volume set. Much more thorough than Theissen or Harrison, but also accepts primacy of Mark. Good set otherwise. (1965)
4. *An Introduction to the New Testament*, Crapps, McKnight, and Smith, Ronald Press. An introduction that displays results of source criticism, etc. However, good for other things, including explanations of current theological ideas. (1969)
5. *Introduction to the New Testament*, Feine, Behm, Kümmel, Abingdon. A German introduction updated by Kümmel. Detailed discussions and European viewpoints. German theological ideas. Akin to position of Crapps, McKnight, Smith. (1966)
6. *Introduction to the New Testament*, Marxsen, Fortress Press. German scholar, definitely advocate of source, form and redaction criticism. Useful when

GOSPELS INTRODUCTION

compared with Briggs, as it shows end results of the positions mentioned here and in his book. (1968)

7. *Interpreting the Gospels*, Briggs, Abingdon. A good presentation of the various schools of thought current in the theological world. (1969)
8. *Jesus of Nazareth: Saviour and Lord*, ed. Henry, Eerdmans. A good book from rather conservative scholars on current theological positions. (1966)

Dictionaries and General Works

9. *International Standard Bible Encyclopedia*, gen. ed Orr, Eerdmans. Five volumes from rather conservative scholars. Much helpful material, though published in 1939. A great contrast can be seen in theological positions between this set and the set from Abingdon. (1939)
10. *Interpreter's Dictionary of the Bible*, gen. ed. Buttrick, Abingdon. Much up-to-date material, and excellent in many ways. However, it reflects the point of view as seen in such introductions as Marxson's, above. (1962)
11. *The New Bible Dictionary*, gen. ed. Douglas, Eerdmans. The best of the one volume dictionaries, though somewhat more expensive than the two following, and with a tendency to reflect the viewpoint of Harrison and Guthrie above. (1962)
12. *Zondervan Pictorial Bible Dictionary*, gen. ed Tenny, Zondervan. The next choice after Eerdmans in regard to material, but somewhat better price for the average church member (1967)
13. *Unger's Bible Dictionary*, gen. ed. Unger, Moody. About as good as Zondervans, except for Unger's premillennialism. (1961)
14. *Jesus the Messiah*, Edersheim, Eerdmans. Very helpful for Jewish customs, etc.

NEW TESTAMENT HISTORY: THE CHRIST

15. *Lessons from the Parables*, Lightfoot, Baker.
16. *Notes on the Parables*, Trench, Baker.
17. *Notes on the Miracles*, Trench, Baker.
18. *Introduction and Early Ministry*, Foster, Baker. A good section on the problems of the Gospels, and about source and form criticism, etc.
19. *The Middle Period*, Foster, Baker.
20. *The Final Week*, Foster, Baker.

Commentaries, 1 volume

21. *Gospel According to Matthew*, Plummer, Eerdmans.
22. *American Commentary on the New Testament*, Matthew, ed. Hovey.
23. *The Gospel of Matthew, Vol. I*, Fowler, College Press.
24. *Commentary on Matthew and Mark*, McGarvey, Standard.
25. *The Gospel According to Mark*, Swete, Eerdmans.
26. *The Gospel of Mark*, Johnson and DeWalt, College Press.
27. *The Gospel According to St. Mark*, Cole, Eerdmans.
28. *The Gospel of Luke*, Geldenhuys, Eerdmans.
29. *Studies in Luke*, Applebury, College Press.
30. *New Testament Commentary, John*, Hendrickson, Baker.
31. *The Gospel According to John*, Morris, Eerdmans.
32. *The Gospel of John*, Turner and Mantey, Eerdmans.
33. *The Gospel According to St. John*, Wescott, Eerdmans.
34. *The Gospel of John*, Butler, College Press.
35. *Adam Clarke's Commentary*, 1 Volume edition, ed. Earle, Baker.
36. *Barnes Notes on the New Testament*, ed. Cobbin, Kregel.
37. *The New Bible Commentary, Revised*, ed. Guthrie and Mayer, Eerdmans.
38. *The Christ of the Gospels*, Shephard, Eerdmans.

GOSPELS INTRODUCTION

39. *The Fourfold Gospel*, McGarvey, Standard.
40. *Studies in the Four Gospels*, Morgan, Revell.
41. *The Expositor's Greek Testament, Gospels and St. John*, ed. Nicoll, Eerdmans.

Commentaries in sets

42. *The International Critical Commentary*, with volumes on each of the Gospels, T. & T. Clark.
43. *Word Pictures in the New Testament*, Robertson, Broadman.
44. *Interpretation of St. Matthew's Gospel*, Lenski, Wartburg Press.
45. *Interpretation of St. Mark's Gospel*, Lenski, Wartburg Press.
46. *Interpretation of St. Luke's Gospel*, Lenski, Wartburg Press.
47. *Interpretation of St. John's Gospel*, Lenski, Wartburg Press.

INTERPRETATION OF THE BIBLE

God has spoken, not only through His Son Jesus, but through men moved by the Holy Spirit. The result of such inspiration is in our Bible. We firmly believe that 1) Jesus promised the Holy Spirit to guide men in their witnessing, Matt. 10:17-20; I Thess. 2:13; etc., and in their writing, I Cor. 14:37, etc., and 2) that the original autographs from these men were without error in fact or thought, even though God used men to produce His will in the form of written letters. However, nowhere did God promise to inspire any person who further transmitted that written word, either in preaching, copying or translating. Thus, no copy which we possess of the original autographs is a product of inspired men, nor is any translation of it, (nor interpretation either, since obviously translation is interpreta-

tion). To argue any other way is to be ridiculous, since there are hundreds of differing translations, varying manuscripts and conflicting interpretations. We think it will be worth a bit of space and time to talk about interpretation of the Bible, in whatever version (translation is the same) you possess. Remember this: there is as much difference between revelation and interpretation as there is between God and man. The first is divine, the second is human. Revelation refers to what God has said. Interpretation refers to what men think God said.

God did not name any method of interpretation nor list any rules as being the best to the exclusion of all others. The Bible was written in man's language to all kinds of people (rich, poor, educated, ignorant, men, women, young, old, of any culture in any time or place) and for all time until Jesus comes again. Now if God did not list any methods nor rules, but did put His will into man's language for men to read and heed, how are we to interpret it? It is important to say that everyone, without any exception, interprets the Bible. Some people claim they do not do so, but rather just "let the Bible say what it says." Great! But what does it say? On that point, few are agreed on much, none agreed on all. Let it also be said that no one can approach a study of the Bible without some presupposition(s). Even the attempt to eliminate all bias and let God speak as He wills is a presupposition—perhaps the best one, but yet a presupposition.

The approach that attempts to understand the author, his circumstances, reasons for writing, background, etc., and how he expected to be understood by his first readers, we consider to be the only reliable method that will keep the student in contact with the text. Since God gave no other instructions in the Bible, we know of no better position to hold and remain Biblical students. That He expected the people who read what was written, to know it

thoroughly, and to pass it on to others hardly needs proof, but see II Tim. 2:2; Heb. 5:11ff.; James 1:21-25; I Pet. 2:1-2; 3:15; etc. This approach is commonly known as the Gramatical-Historical, and uses the inductive method of study. It assumes that God expected His Word to be read and studied as any piece of literature made up of words in sentences, etc. The method does not expect or need anything miraculous to be used in discerning God's will. God did not write His book in such a way that the one interpreting it would have to have a revelation from Him to understand the revelation from Him in the Bible. The Bible would be useless if such were the case, since it would have no message for us, the words being meaningless without divine revelation to explain them. If God has given everyone an interpretation who prayed for it, God is quite obviously the author of confusion! We may feel that need to ask God to help us let the Word eliminate from our lives the sinful ideas, etc., that keep us from allowing that Word to speak to us as it can. Yet that is the reason for the Bible: to make us into persons who are the measure of the stature of the fullness of Christ! God has done His part—it is up to us to do our part.

The inductive method is not infallible, if for no other reason than that fallible men use it. Finite (fallible) man is unable to be or do anything perfectly. The only realm where perfection lies is where God is. Hence it quite clearly follows that though we have from God an infallible revelation, no infallible interpretation (other than what is given in that infallible revelation) is possible for men of all God has said. This is not to say that He does not expect us to study it and practice it, learning as we live. Salvation can be found no other way. It is simply an affirmation that fallible people are not capable of perfect interpretation all the time. Good and honest men have labored over Bible passages for a lifetime and have been

unsure of what was meant (read here II Pet. 3:16a.). Try Eph. 4:8-10 or Rev. 20:1-6 as examples. It is not shameful to admit some passages are "hard to understand" and need further study.

If the reader concludes that this position leaves all persons to be their own judge of the interpretation they hold as to its correctness, and so practice as they understand, all others notwithstanding, said reader is correct. To disclaim the practice of the Roman Catholic Church and its infallible interpretation (not to mention current Neo-Orthodox and existential theologians), yet to set one man, a group of men, or religious denomination up as having "the infallible interpretation" is not different in principle. If it be said then that such a position means that no one knows absolutely about all or any interpretations, that is also correct, and so much the better. People do not need judges—they need the right to interpret God's revelation and practice as they so understand. God so intended that that is all anyone needs. Whether He will excuse some or all for little or much bad interpretation is His business. Our business is to give ourselves whole-heartedly to discerning His will for our own lives and doing it. He expects each believer to encourage others to do likewise. If we do those two things well, we shall be plenty busy, far too busy to "play God" for other men, by which is meant that we can not determine absolutely about anyone's faith or obedience. We may offer help where it appears to be needed, and this God expects (Matt. 7:2-5), but beyond that we have no authority to go.

The process begins by actually recognizing thought units known as *words*. Whether composed of one letter or many, we attempt to understand how it fits into the phrase, clause, paragraph, book, etc. Usage alone determines the meaning of a word. We may utilize other things, such as etymology, composition, etc., but it finally boils down to

GOSPELS INTRODUCTION

this: the author meant it to be understood as he used it. The relationship to the *sentence* construction, and larger *context* may help determine that meaning. The subject under discussion, the book in which we find the passage, any *parallel passages* in other books, the larger context of the writer and first readers, (i.e. *historical circumstances*): all must be considered.

No other method but the inductive method allows (yea, demands) that all the facts be heard, and the conclusion drawn only when such is done. We are obligated to study God's Word, and obey it as we understand it. We may become more perfect in our understanding, and so become better disciples, even as Peter did. But we must extend to every person the same right as we ask for ourselves: the right to read and heed as one understands.

No one has an infallible interpretation of all of God's Word. All have some, doubtless. But there it ends. We would not have any way of recognizing the fact that some one had an infallible interpretation of all of it (except by revelation from God) but by usage of the inductive method. Yet God expects us to read and heed: primarily to receive salvation in Christ, and to teach others of Him. We know of no other method by which to discern the Lord's way except to read the written Word and act as we understand it. God's word can be understood, adequately enough to become Christian and live a godly life, growing in grace and knowledge, II Pet. 3:18. Millions of people have done so for 20 centuries! You can, too! (By the way, if you have understood some or all of what you have just read, what method and rules did you use?)

We conclude by affirming our whole-hearted allegiance to God's Word, and encourage you who read this to do the same, while at the same time discouraging allegiance to any interpretation of it. We believe that any translation of God's Word (as given in the original autographs) can be

used to direct men to a saving relationship to Jesus Christ, and to teach such persons to lead a godly life. Some translations are better than others, but all can be used to further the kingdom of our Lord here on earth. Likewise, we encourage the use of commentaries, etc. Even though men disagree in those commentaries, comparisons are helpful, as are new ideas. Don't be afraid to use aids; just be alert to the fact that men are given to error in thinking and yet can be helpful to spiritual growth.

LEPROSY — SOME FACTS AND FANTASIES

First, read Leviticus 13 and 14 in your Bible, and try to read it in some modern version like New American Standard, etc., if you can. See also Ex. 4:6; Num. 12:10; II Kings 5:27. There has been needless worry as well as mental suffering over this disease of the Bible. Part of it is because of translation problems, part of it is because of failure to read the text carefully and understand the reason for the treatment of lepers. Certainly a failure to understand God's reasons for commanding the Israelites to do certain things has caused part of the trouble with leprosy. We recommend that everyone read S. J. McMillen's book, *None of These Diseases* (Spire books, Revell) to help in understanding why God commanded the Israelites to do certain things along the line of cleanliness, etc.

Let it be noted that the Bible does not state anywhere that the leper was equal to nor to be treated as a sinner. That the people of Israel all sinned is a rather evident fact—but all who sinned were not required to live outside the camp or village! Everyone would have been outside the camp had that been the case. But lepers were required to live apart from others—doubtless not because

leprosy was worse than sin! The ostracism from society was for an entirely different reason—the “leprosy” was probably contagious, and this was God’s means of “isolation” and quarantine.

The problem arose over the translation of the Hebrew word *tsaraath* and the Greek word *lepra*. These words basically denoted a scaling or peeling condition. The Hebrew term was hence applied to a *number of skin conditions*, which would include something like psoriasis or Leucoderma, which appear with a whiteness, as the “leprosy” in Leviticus 13 and 14 shows. Leprosy (Hansen’s disease) is not white. The word in Greek (*lepra*) came into Jerome’s Latin Vulgate (ca. A.D. 400) as *leprosus*, and from this we get our English word leprosy. The term may have included what we today know as leprosy, but it is rather unlikely.

There are several reasons why modern day leprosy is not what is in the Bible. The appearance is not the same. The affliction in the Bible could be determined in a very short time, and such a short time for the diagnosis of modern day leprosy (better known as Hansen’s disease, after the Norwegian doctor Armauer Hansen, who isolated and identified the leprosy bacillus in 1872. Its Latin term is *Mycobacterium Leprae*.) would be rather difficult. The Bible leprosy could be found in the stone and woodwork of houses, 14:33-57, and in clothing, 13:47-59. Hansen’s disease hardly fits that category. The exclusion from society of the Bible leper was probably because the various skin afflictions included under the Hebrew term *tsaraath* or Greek term *lepra* were infectious and communicable. Hansen’s disease is hardly that, being one of the least communicable diseases known. Modern physicians have established that it is less infectious than tuberculosis. At Carville, up until 1949, with some 50 years of operation, not one doctor or nurse became infected. The same general

fact is applicable to other leper hospitals such as the San Lazaro Leper hospital in the Philippines. The disease is apparently not inherited, though children of leprous parents show a tendency to also develop the disease.

Modern drugs have greatly aided the cure of Hansen's disease. Research especially in India has shown that patients can be cured, and usage of bodily extremities can be helped or cured. One of the problems with Hansen's disease is that it affects nerve endings which results in loss of feeling in the member affected. Thus fingers and toes are often worn off literally, or burned off, etc., because the patient does not realize what is happening.

Modern methods and drugs have greatly helped the people afflicted with Hansen's disease. Many are suggesting that the patients can be treated in doctor's offices just as any other patients, and, in fact, some have and are being treated that way.

If the same sort of effort were made to remove the stigma from the term leprosy, and to completely disassociate the Bible term from Hansen's disease, since they are not identical, much needless mental agony and physical distress caused by false misconceptions among the general public would be removed, and a great service would be rendered many people.

DEATH: WHAT IS IT?

Some religious groups, and others within religious groups, hold the basic position that the people who do not go to heaven, when sentenced by God to hell, are then annihilated, and cease to exist. Thus, the punishment is eternal in its consequence and duration, though not in the person's existence or punishment endured endlessly while existing. The argument is several-sided and not capable of absolute solution either way, though we do not

consider the Bible to teach annihilation at all. However, some do, and argue that a loving God would not sentence anyone to eternal punishment such as is normally considered to be taught in the Bible. Of course this position attempts to decide what a God Who loves everybody would do, which is quite impossible. God loved the world, but not enough to save it in its sin, and so sent Jesus to die for it. Yet that death did not save anyone except those who accept it—that is a Bible fact, if anything is. Love is not soft on sin, nor sinners. God may have loved the world, but that love is not expressed but through His will, such will being also just and good. God expressed His love in chastening His children, Heb. 12. God loved Israel enough to do many things for them, but not enough to forgive them other than on the conditions He laid down for them. Hence, many who left Egypt did not enter the Promised Land, Heb. 3:7—4:13. David was loved, but still Nathan came with the stern rebuke, and his son by Bathsheba died. God loved the apostle James, but Herod still beheaded him. God so loves each one that He is unwilling for any to perish, but the wages of sin is still death. And this last word “death” brings up the basic issue: what is meant by death. The terms perish, destroy, punishment, lost, and their related terms are also involved.

We do not have space to give an extended discussion of all of these terms. We suggest that ch. 8 of R. C. Foster’s book, *The Final Week* from Baker, be read on this subject, or the extensive debate by A. Campbell and D. Skinner published by College Press. Wilbur Fields has a mimeographed essay in Ozark Bible College Bookstore on this same subject, to whose essay and Bro. Foster’s book I am somewhat indebted for material in this essay.

That the word “death” in itself does not mean annihilation is obvious. Everyone dies physically, but the

body simply changes states. It becomes again dust. That nothing is actually destroyed in the material world is about as sure a principle as we know. Hence death in a physical sense means a change of state. So the argument moves to the sphere of the spiritual, and the meaning of death in that realm. Now it is interesting that the Bible does not use the terms "spiritual" and "death" together. That there is a spiritual realm and a physical realm is clear, however. One can not help but wonder if the only real realm is the spiritual, or non-material. God is real—and also spirit. All things material are temporal. From this viewpoint, defining what is "real" in terms of whether something lasts forever or not would make the spiritual world the only real world.

As far as the word "death" itself, we have shown in the discussion of Matt. 22:23-33 (# 72 (6)) and of John 11 (# 62) that Jesus taught that all live to God, whether physically "dead" or not, and the dead are not "dead" to Him. That the word death does not necessarily mean extinction is patent. Rev. 20:12 speaks of "the dead" very much in existence, and v. 14 speaks of a "second death" (how could there be a "second" death if the word death always means annihilation?) which is identified in relationship to the lake of fire that is to burn forever, v. 10. That the wicked dead are to be thrown in that lake is clear from v. 15. The text does not say annihilated. That beings can be thrown into the lake and not annihilated is clear from v. 10. So the word "death" does not within itself mean cessation of existence, though it may well depict either a change of state, loss of well-being or both. That it is not a term equal to annihilation is also seen in Gen. 2:17; Ezek. 18:20; Luke 9:60; Rom. 6:2-11; Eph. 2:1; Col. 3:3; I Tim. 5:6; and numerous other scriptures akin to these.

In Bible times, the Sadducees taught that death meant

GOSPELS INTRODUCTION

extinction. The apostle Paul, some years after his conversion, did not agree with them, but rather held the view that there is life after the exodus from the body, and that all will be resurrected, Acts 23:1ff. It seems rather clear that God had not revealed anything contrary to him, (such as the doctrine of the Sadducees being true) and none of his letters so speak. In that text, he remarks about his belief in the resurrection, and in 24:14, 15 he makes it plain that the O.T. taught such a doctrine. Jesus plainly said the same in the discussion with the Sadducees. So the Old Testament is clear on that subject. Other people in the Old Testament times so taught. Note David in II Sam. 12:23 and Psalms 23:4; Job in 19:25-26; Martha in John 11:24. Abraham (very much in existence, Luke 16:19-31 some 2,000 years after he died) was gathered to his "people," Gen. 25:8, which surely does not refer to his body but his spirit; likewise with Aaron in Num. 20:24. Note Enoch, Gen. 5:24, and Elijah, II Kings 2:42.

That a person is not equal to the body in which that person lives is also plain—see II Cor. 5:1-9; Phil. 1:21-23; Heb. 12:23; James 2:26; I Pet. 3:19; II Pet. 1:13-14; Rev. 6:9-12. God is spirit, Jn. 4:23-24, and we are in His image in this regard, but certainly not in material body. Man is a spirit as God, has innate life (called soul) through that spirit, and while on earth dwells in a body. So the Bible differentiates between each of these three aspects of humans, I Thess. 5:23; Heb. 4:12-13.

As to the words rendered "everlasting/eternal," perish, destroy, lost, etc., none of them mean cessation of existence necessarily, but all convey the idea of a change of state, loss of well-being, or both. There is hardly any point in fire, destruction, and worms, etc., being unquenchable (Matt. 25:41, 46; Mk. 9:44-50; Rev. 14:9-11) if the dead cease to exist at the moment of their sentencing. The point of such descriptions and ceaseless punishment is to

get men's minds on the "real," the "good" and the "holy" rather than being blinded by the god of this world, II Cor. 4:4. Hell can hardly be a place to be feared and avoided, and where men weep and gnash their teeth (Mt. 8:12; 25:30; Mk. 9:44-50; Luke 12:47-48; 13:28) when no one is there because of lack of existence! Note the word translated "eternal/everlasting" in Mt. 19:16; 25:46 (twice); Acts 13:46; Rom. 16:26; Heb. 9:14; I Pet. 1:11; etc.

That the words destruction, perish and lost are also terms that must be understood in relationship to their usage, and do not mean or equal annihilation necessarily is also a fact.

The word *appollumi* and its derivatives does not mean cease to exist, extinction. It means loss of state or well-being. It can be translated as destroy, perish, lost, etc. Now see Mt. 27:10; Mt. 8:29 and Mk. 1:24; 14:4; Luke 5:37; 15:8, 24, 32; John 6:27; 17:12; Acts 25:16; I Pet. 1:7; II Pet. 3:6. The basic idea is not annihilation at all, but ruin or loss.

The same is true for *olethros*, which is translated destruction. Like the other words, it signifies a great loss, or tragedy. Note II Thess. 1:6-9 and the words associated with it there, as affliction, vengeance, and eternal. Now see I Cor. 5:5; I Thess. 5:3; I Tim. 6:9; the only other places where it occurs. Foster notes that Greek writers of N.T. days did not use the word to mean annihilation, but something bringing on tragic consequences, or the result therefrom. Sophocles has his main character in the Greek drama "Oedipus Rex" cry out, "I am the great *Olethros*" or supreme example of suffering, not extinction.

The third Greek term *kolasis* is also a point of contention. It occurs in Acts 4:21; Mt. 25:46; II Pet. 2:9; and I Jn. 4:18. In none of these places does it denote annihilation, but punishment or anguish or suffering. It

was often so used in the classical writers of the same period as the N.T. writers, or with the idea of chastise.

Passages in Revelation teach both continued existence after death and judgment, plus suffering, as in Rev. 14:9-11. "They" are not annihilated but punished in torment forever, since "they" who are sentenced to be tormented with fire and brimstone have the "smoke of their torment" going up "forever and ever." See also Rev. 21:8. Some find fault with the book of Revelation, saying that it is symbolic, not literal. That may be true, but it does not teach untruth because it is of such nature. If the real is worse than the symbol . . . !

We conclude by saying that we consider that I Cor. 15:1-58 teaches that everyone will be resurrected at the last day (see also Jn. 5:28-29), therefore "death" does not mean extinction at all. Those who pass out of this earthly existence not a part of Christ will appear at God's judgment bar to be sentenced according to their life here on earth, Rom. 14:12; II Cor. 5:10; Rev. 20:11-13; etc. Their punishment will be in a place prepared for the devil and his angels, Mt. 25:41, and for an endless time remain there, very much in existence. Now—the reader may not agree with the conclusion expressed. Suppose that "hell" is non-existent. No one has to worry at all. But if it is, and one goes to meet God unprepared (Acts 17:30, 31; II Cor. 5:11; Heb. 10:26-31) then for all eternity that person will wish his earthly life had been lived in the fear of God. Who wants to take chances with such high stakes?

QUIRINIUS (CYRENIUS IN K.J.) AND THE CENSUS, LUKE 2:1-5

Luke's standing as an accurate historian has been assailed many times, but never more than about the statements in 2:1-5. It was known that Quirinius had been

governor of Syria in A.D. 6. But no evidence was to be had for 1) an enrollment ordered by the Roman emperor as Luke mentions, 2) or that Quirinius was governor of Syria at the time demanded by Luke's statement. Generally speaking, in the past and even in the present, any-time Luke mentioned facts such as those in 2:1-5, if no other historian gave evidence of the same facts, Luke was considered in error. Hence it was that the believer in Luke's accuracy had to maintain that position on the strength of the credibility of Luke. Often, men made fun of those who considered Luke accurate despite corroborating evidence for Luke.

However, in the last 50 years or so, plenty of evidence has been uncovered to exonerate Luke, and plainly show that he was entirely accurate in his statements. The interested reader may read the detailed accounts in A. T. Robertson's book, *Luke the Historian in the Light of Research*, ch. 9; Sir Wm. Ramsay's book, *The Bearing of Recent Discovery on the Trustworthiness of the New Testament*, pp. 223ff.; and Leon Morris' book on the Gospel of Luke, pp. 104-106.

Be it said that there is plenty of evidence for a census every 14 years, both at the time of Jesus' birth and for two centuries later, in all parts of the Roman empire; that people were required to go to their domestic homes to so be enrolled. Note that the Greek word means to be enrolled (The same Greek word occurs in papyri for enrollments as Luke uses), not taxed, though taxation may have been one result of it. Let it also be noted that Luke only states that Augustus Caesar had given a general order for a universal enrollment. It is not stated how or when that enrollment was to be done. Luke notes another census in Acts 5, but does not state that they are the same at all. Enrollment papers have been found for as early as 20 A.D. The census prior to that would occur

GOSPELS INTRODUCTION

about 6 A.D., and the one prior to that 8 B.C. The last one quite well fits into the time for Jesus' birth.

That this is probably true is said in relationship to the fact that inscriptions are known which place Quirinius in Syria at about 8-6 B.C. He was engaged in an official capacity (note that we are not sure what Luke means by his word "governor", in Greek *hēgemoneuontos*. This word occurs in such passages as Mt. 2:6; 10:18; 13:9; 27:2; Lk. 20:20; 22:26; Acts 7:10; 23:24; II Cor. 9:5; Phil. 2:3; Heb. 13:7, 17 etc.) in the country of Syria, and perhaps as an imperial legate, or even military leader, since the Romans were engaged in the Homonadencian War. There is an inscription extant which may well indicate he held such a position.

The papyri finds and inscriptions, etc., indicate that women were not necessarily required to enroll. But if Mary was in the condition she apparently was, it is rather unlikely that Joseph would go all the way from Nazareth to Bethlehem and leave her behind. The fact that he stayed in Bethlehem after the birth, and was going to return to Bethlehem from Egypt may indicate that he "moved" to Bethlehem, expecting to remain there.

WHO OR WHAT IS THE HOLY SPIRIT?

by Seth Wilson

- I. The Holy Spirit is a person (a thinking, feeling, acting, responsible individual).
 - A. He is said to do what only persons can do.
 1. He speaks, I Tim. 4:1; Rev. 2:7; etc.
 2. He testifies, John 15:26.
 3. He teaches, John 14:26; I Cor. 2:13.
 4. He searches and reveals, I Cor. 2:10.
 5. He leads and forbids, Acts 16:6, 7.

B. He is said to have characteristics of a person.

1. Mind, Rom. 8:27.
2. Knowledge, I Cor. 2:11.
3. Affection, or love, Rom. 15:30.
4. Will, I Cor. 12:11.
5. Being grieved or vexed, Isa. 63:10; Eph. 4:30.
6. Being resisted, Acts 7:51.
7. Being lied to, Acts 5:3.
8. Being despised or scorned, Heb. 10:29.

C. Personal pronouns in the masculine gender are applied to Him, in close connection with the noun "spirit" which is neuter and should normally have all of its pronouns and modifiers in the neuter, Jn. 15:26; 16:7, 8, 13, 14.

D. The Spirit is not a mere impersonal force or influence which we somehow get hold of and use; but He is a personal being, wise and holy, who is to get hold of us and use us. He is one with whom we may have the closest friendship, or fellowship. Phil. 2:1; II Cor. 13:14. He enters into our personalities, and we become new persons, with renewed minds, affections, desires and wills.

If we have trouble thinking clearly and distinctly about the Spirit of God, it probably is because we do not understand clearly our own spirits. But we can accept the fact that He is a person like Jesus Christ, except for the body Jesus used, or like ourselves in that He has the essential faculties that make us to be persons rather than material machines.

II. The Holy Spirit is a Divine Person, with Deity like that of God and Christ.

A. He is said to have the attributes of God.

1. He is eternal, Heb. 9:14; was with God in creation, Gen. 1:2.

GOSPELS INTRODUCTION

2. Knows what God knows, I Cor. 2:10, 11.
 3. He exerts the power of God, Luke 1:35; Acts 1:8; Mic. 3:8; Judges 14:6.
 4. He is everywhere present as God is, Psalms 139:7-10.
 5. He is holy, the Spirit of holiness (Rom. 1:4); Spirit of grace (Heb. 10:29); Spirit of truth (John 14:17; 16:13); Spirit of wisdom (Isa. 11:2).
- B. The works of the Spirit are the works of God.
1. Creation, Gen. 1:2; Job 33:4; Ps. 104:30.
 2. Giving life, Gen. 2:7; Rom. 8:11; John 6:63; John 3:5.
 3. Authorship of prophecies, II Pet. 1:21.
 4. Working of miracles, Matt. 12:28; I Cor. 12:9, 11.
- C. The Holy Spirit is the Spirit of God, the Spirit of Christ, and is spoken of in such connection with God and Christ that it shows they are of the same divine nature, I Cor. 12:4-6; Matt. 28:19; Acts 5:3, 4; II Cor. 13:14.

In addition to Bro. Wilson's essay above, we add the following information about the Holy Spirit.

I. Holy Spirit in lives of people.

A. John the Baptist

1. Luke 1:15 to be filled with H.S. from birth, thus ministry guided by H.S.

B. Simeon

1. Luke 2:25, full of H.S., 2:26, revelation to him by Holy Spirit.
Luke 2:27, led by H.S. to temple, revealed unto him babe was Messiah.
2. prophecy (vs. 34-35) probably under Spirit's guidance.

C. Mary

1. Mt. 1:18-29; Luke 1:35, child to be begotten by Holy Spirit.
2. prophecy (1:46-55) probably under Spirit's guidance.

D. Elizabeth

1. Luke 1:41, filled with H.S.
2. Luke 1:42-45, prophecy through H.S.

E. Zechariah

1. Luke 1:67, filled with H.S.
2. Luke 1:68-79, prophecy through H.S.

F. Saul/Paul

1. Acts 9:17; 13:9, filled with H.S.
2. Acts 13:2-4; 16:6-7, led by H.S.
3. Acts 20:23, H.S. witnessed to him about impending trouble.
4. Acts 21:4, 11, Disciples at Tyre and Agabus through H.S. told of impending trouble.
5. Rom. 9:1, H.S. bears witness that he cared about fellow countrymen.
6. Rom. 15:19, ministry aided and empowered by H.S. Cf. I Cor. 2:4; II Cor. 6:6.
7. I Cor. 7:40, states fact of having H.S. which is reason for taking epistles as God's own Word. See I Thess. 1:5.
8. Acts 19:6; Rom. 1:11; II Tim. 1:6, imparted spiritual gifts by laying on of his hands.
9. Phil. 1:19, Paul's expected release to be helped by H.S.

G. Jesus

1. Mt. 1:18-20; Luke 1:35, begotten by H.S.
2. Mt. 3:16; Mk. 1:10; Luke 3:22; John 1:32, descended upon him at baptism.
3. Mt. 12:18; Acts 10:38, anointed with H.S. Cf. Heb. 1:9.

GOSPELS INTRODUCTION

4. Mt. 3:11; Mk. 1:8; Lk. 3:16; Jn. 1:33, immerses others with H.S.
 5. Mt. 4:1; Lk. 4:1, led by Spirit into the wilderness.
 6. Mk. 1:12, Spirit drives Jesus into the wilderness.
 7. Mt. 12:28, cast out demons by power of H.S.
 8. Luke 4:1; John 3:34, filled without limit with H.S.
 9. Luke 4:14, went into Galilee in power of H.S.
 10. Luke 4:18, claimed preaching was because H.S. was upon Him.
 11. John 1:33, H.S. identification of Jesus for John.
 12. Acts 1:2; Rev. 19:10, preaching through H.S.
 13. Acts 1:2, gave commands through H.S.
 14. Rom. 1:4; I John 5:7-8, H.S. bears testimony of Jesus' life.
 15. I Tim. 3:16, justified by H.S.
 16. Heb. 9:14, offered Himself through *eternal* Spirit.
 17. I Peter 3:18, made alive through H.S.; Preached to pre-flood world through Noah through Spirit in Noah. Cf. Gen. 6:3.
- II. Immersion of, filled with, guidance of Holy Spirit.
- A. Immersion of Holy Spirit.
1. Acts 1:5, promised by Jesus to apostles only. Cf. Jn. 14:16-17, 26; 15:26; 16:13-14; Acts 1:8. These verses plus Mt. 10:19-20; Mk. 13:11; Lk. 12:12 pinpoint apostles as ones to receive immersion of Holy Spirit. They also show the people meant by John the Baptist in Mt. 3:11; Mk. 1:8; Lk. 3:16; Jn. 1:33.
 2. Fulfillment of promise in Acts 2:1-4. Cf.

NEW TESTAMENT HISTORY: THE CHRIST

- Acts 2:33; also Jn. 20:22 where Spirit is promised to apostles.
3. Acts 10:44-48; 11:15-16; 15:8, immersion is a sign of God's approval of Gentiles to Peter and brethren with him, as well as to all Jews.
- B. People filled with Holy Spirit.
1. Lk. 1:15; John the Baptist to be filled from mother's womb.
 2. Lk. 1:41, Elizabeth.
 3. Lk. 1:67, Zechariah.
 4. Lk. 4:1, Jesus.
 5. Acts 2:4; 4:31, apostles.
 6. Acts 4:8, Peter.
 7. Acts 6:3-4, 7, deacon's qualification.
 8. Acts 7:55, Stephen.
 9. Acts 9:17; 13:9, Saul (Paul).
 10. Acts 11:24, Barnabas.
 11. Acts 13:52, disciples at Antioch of Pisidia.
- C. People given guidance by Holy Spirit.
1. Mt. 4:1; Mk. 1:12; Lk. 4:1, Jesus.
 2. Acts 8:19, 39, Philip.
 3. Acts 10:19; 11:12, Peter.
 4. Acts 13:2-4; men in church at Antioch of Pisidia.
 5. Acts 16:6-7, Paul and Silas.
- D. Holy Spirit helps prophets and others.
1. David, Mt. 22:43; Mk. 12:36; Acts 1:16-20; 4:25-26; Heb. 3:7-11.
 2. Isaiah, Acts 28:25-27.
 3. Jeremiah, Heb. 10:16-17.
 4. Apostles, Acts 2:4.
 5. Peter, Acts 2:22-41.
 6. Disciples at Tyre, Acts 21:4.
 7. Agabus, Acts 11:28; 21:11.
 8. Early preachers of gospel, I Peter 1:12.

GOSPELS INTRODUCTION

III. General information about Holy Spirit.

1. Not to come until after Jesus went back to heaven, Jn. 7:38-39; 14:26; 15:16; 16:7-13.
2. Offers invitation, Rev. 22:17. Cf. Lk. 8:11; Rom. 10:14-17; Eph. 3:5; 6:17.
3. Jn. 3:6, Spirit produces spiritual beings, impossible through natural processes of birth. (See Jn. 6:63).
4. Acts 2:18, subject of prophecy.
5. Acts 2:33, Pentecost experiences result of Jesus going back to heaven.
6. Acts 19:1-2, Spirit to be received at time of baptism; perhaps should be taught about at this time.
7. Quoted by N.T. writers, Acts 20:23; I Tim. 4:1; Rev. 14:13.
8. Unpardonable sin against Holy Spirit, Mt. 12:31-32; Mk. 3:28; Lk. 12:10. Cf. Heb. 10:26-29.
9. Spirit versus law, Rom. 2:28-29; 7:6; II Cor. 3:6-18; Gal. 3:2-5; 4:3-7; 5:18.
10. Spirit and His Word (Bible), Lk. 8:11; Jn. 6:63; Gal. 3:2-5; Eph. 6-17; Heb. 4:12; James 1:18; I Peter 1:22-23.
11. Spirit comes to dwell personally through hearing, Gal. 3:2-5, 14. Cf. II Tim. 1:14.
12. Jude 19, unbelievers don't have Him. Cf. Rom. 9:9 and Acts 2:39; Eph. 4:30 and I Thess. 5:19; Gal. 5:16-25 and Eph. 5:18 as seen in light of Gal. 3:25; Rom. 10:17.
13. Just one Holy Spirit, I Cor. 12:4, 9, 11, 13; Eph. 4:3-6.
14. II Timothy 1:14, Timothy to guard his committed trust which came through the Holy Spirit.

IV. Holy Spirit and spiritual gifts.

1. Gifts and giving discussed in I Cor. 12:4-11. All of chs. 12, 13 and 14 are about gifts of special nature and early church.
2. Gifts given to early Christians given through laying on of apostles' hands. Cf. Acts 6:6; 8:14-19; 19:6; Rom. 1:11; II Tim. 1:6.

V. Holy Spirit and Church.

A. General references.

1. Acts 9:31, gives comfort to church.
2. Acts 15:28, Holy Spirit helps make decision about Mosiac Law.
3. Acts 20:28, Ephesian elders made overseers through Holy Spirit.
4. I Cor. 3:16, church as a unit said to be dwelling place of Holy Spirit.
5. Eph. 4:3, church urged to keep unity of Spirit.
6. Rev. 2:7, 11, 17, 29; 3:6, 13, 22, Spirit speaks to churches.

VI. Holy Spirit and Christian.

A. General references.

1. Prayer, Rom. 8:26-27; Eph. 2:18; 6:18; Jude 20.
2. Sealing, II Cor. 1:22; Eph. 1:13; 4:30.
3. Sanctification, Rom. 15:16; I Cor. 6:11; II Thess. 2:13; I Peter 1:2.
4. All penitent believers receive same Spirit, Acts 2:38; I Cor. 12:4, 9, 11, 13; II Cor. 11:4, (Cf. Mt. 28:19); and partake of same Spirit, Heb. 6:4.
5. Jn. 3:8, everyone begotten by Spirit gives evidence of it.
6. Rom. 8:2, Law of Spirit of life (name for gospel) gives freedom from sin and death.

GOSPELS INTRODUCTION

7. Rom. 8:4, Spirit-led people through Jesus' death escape demand of law (death).
8. Rom. 8:5, Spirit-led people follow after things of Spirit.
9. Rom. 8:6, life and peace come through mind-ing things of Spirit.
10. Rom. 8:9, If Spirit dwells in us, we are doing will of Spirit, not will of flesh.
11. Rom. 8:11, Spirit is means of our future resurrection.
12. Rom. 8:16; Gal. 4:6, Spirit bears witness with our spirit that we are sons of God.
13. Rom. 8:23, Christians have first-fruits, or things that come through Spirit.
14. Rom. 15:13; Eph. 3:16, Spirit helps empower Christians' life.
15. Rom. 15:30, Love of Spirit is motivating factor in prayer. Cf. Col. 1:8.
16. I Cor. 6:11, Christians are washed, sanctified and justified in name of Christ and in Spirit of God.
17. I Cor. 12:3, men guided by Spirit call Jesus Lord. Cf. I John 4:2-3.
18. II Cor. 3:3, Christians become epistles of Christ to men through Spirit.
19. II Cor. 13:14; Phil. 2:1, fellowship enjoyed by Christians through Spirit.
20. Gal. 4:29, Christians are like Isaac: children (partakers) of promise.
21. Gal. 5:5, Through Spirit by faith we look for hope of salvation.
22. Gal. 6:8, allowing Spirit to lead *guarantees* eternal life.
23. Eph. 2:22, Christian dwelling place of God

- through Spirit, Cf. II Tim. 1:14; I John 3:24; 4:13; I Thess. 4:8, whom God gives us.
24. I Thess. 1:6, joy received by Christians through Spirit. Cf. Gal. 5:22-23.
 25. II Tim. 1:7, Spirit brings, not fear, but power, love and discipline.
 26. I Peter 4:14, through Spirit's indwelling, we live like Christ and thus may be targets for reproach.

PALESTINE, A GLIMPSE OF THE CLIMATE

The following is written for the purpose of acquainting you with the land where Jesus lived. The article could have been expanded considerably, but at least it will give you a glimpse of the land God gave to Abraham and his descendants. Several references are often given, with a part of one of the verses sometimes quoted. You can look up the others. If it will make the land more real to you, and cause you to "see" in your minds' eye real people in a real land, the result intended has been accomplished.

The land is at most 90 miles wide by 150 long, though David controlled more than this area. The normal designation was from Dan to Beersheba. O.T. Palestine probably covered about 10,000 square miles, with N.T. Palestine somewhat larger.

Two basic seasons: summer, generally hot and dry, extending from May to October. Winter, moist and rainy, mild. Joppa has an average temperature of 57 degrees. Jerusalem, about 34 miles east, 2600' elevation, has 63 degrees average, while Jericho, only 15 miles further east but 700' below sea level, sustains tropical temperatures.

GOSPELS INTRODUCTION

Summer is harvest time, and hot, dry, windy. Consider the following references along this line: Gen. 8:22, "While the earth remains . . . cold and heat, summer and winter, day and night, shall not cease." Job 37:9; Ps. 32:4; "For day and night thy hand was heavy upon me; my strength was dried up as by the heat of summer," 83:13-14. Often the Bible speaks of the heat of the day, or the hot day, as in the following: Gen. 8:22; 18:1, "And the Lord appeared to him by the oaks of Mamre . . . in the heat of the day." Ex. 16:21; I Sam. 11:9, 11; II Sam. 4:5; Neh. 7:3; Job 24:19; 30:3; Ps. 19:6; Isa. 4:6; 25:4, 5; 49:10; Mk. 4:6, "and when the sun rose it was scorched . . ." and James 1:11. Sometimes, because of the intense summer heat, and dry, scorching winds, the people longed for some shade. Note the following passages: Job 7:2; Ps. 17:8; Isa. 32:2; Mic. 4:4; Hos. 4:13; Jon. 4:6, 8, "And the Lord God appointed a plant . . . that it might be a shade over his head, to save him from his discomfort." "When the sun rose, God appointed a sultry east wind, and the sun beat upon the head of Jonah so that he was faint . . ." What about the cool of the day Gen. 3:8? The men who worked in the vineyard all day complained about the heat of the day in which they had to work, while the latecomers rested in the shade and yet got paid the same, Mt. 20:12.

Winter was time to plow the ground, softened by the early rains, and get ready for the spring planting. The early rains came in late October or early November, and the cooler season then ran through April, during which time the later rains fell. Since the country varied from the snow on Mt. Hermon (9,100 feet elevation) to the Jordan valley (the Ghor) and the Dead Sea (1,292' below sea level) down into the desert area of the Negeb (the Sinai peninsula), extremes of temperature were found. Consider the following: Gen. 8:22; Job 37:9; Prov. 20:4,

"The sluggard does not plow in the autumn; he will seek a harvest and have nothing;" 25:20; Mt. 24:19, 20; John 10:23; 18:18, "Now the servants and officers had made a charcoal fire, because it was cold . . . Peter also was with them, standing and warming himself." Acts 27:12; 28:2; II Cor. 11:27; II Tim. 4:21; Rev. 3:15, 16; which speak of winter and cold weather in general. We will note that ice, frost, snow and chilly rains all occurred in other references.

Wind was an important factor in this land. It brought cooling breezes from the Mediterranean Sea, or clouds with rain (I Kings 18) so that the western slopes of the land were reasonably well watered, though on the eastern slope and down into the Jordan valley, the land was much more dry, with the Dead Sea area receiving often only 1-2 inches of rain per year. Much of the Negeb is very arid, and present day inhabitants "dry-farm" by means of dew, or irrigate. Remember the problems of the children of Israel when they were there.

Generally the winds are from the west, swinging to the south in the summer and to the NW in the winter. The deep rift of the Jordan valley, falling from about 1,700' above sea level at the source near Mt. Hermon to 1,290' below sea level at the Dead Sea in approximately 100 miles, obviously creates temperatures and land extremes that bring sudden storms (as on the Sea of Galilee). The wind normally rises about 9 a.m. and blows until 4 p.m. This provides the harvester with a means of threshing grain, as in Mt. 3:12. Sometimes the Bible uses wind as a symbol of judgment, as in Isa. 5:28; 41:16; Jer. 4:13, "Behold, he comes up like clouds, his chariots like the whirlwind." Cf. Dan. 11:40; Amos 1:14ff.; Mt. 3:12; 7:24ff.

The wind is often described as a whirlwind, or a gusty, strong wind, as in II Kings 2:11; Job 38:1; 40:6;

GOSPELS INTRODUCTION

Ps. 107:29, "he made the storm be still, and the waves of the sea were hushed." Isa. 40:24, "Scarcely are they planted, scarcely sown . . . when he blows upon them, and they wither, and the tempest carries them off like stubble." Sometimes an east wind is mentioned, blowing in from the Arabian desert. Often it was an "ill" wind, as in Job 1:19, "and behold, a great wind came across the wilderness . . . and it fell upon the young people, and they are dead." Jer. 18:17, "Like the east wind I will scatter them before the enemy; I will show them my back, not my face, in the day of their calamity;" Ezek. 17:10; 27:26. The wind is often considered in connection with a storm, with rain or hail, as in I Kings 19:11; Job 21:18; 30:22; 37:9; Prov. 1:27, "when panic strikes you like a storm, and your calamity comes like a whirlwind." Cf. Prov. 10:25; Isa. 5:28; 25:4; Mt. 8:23-27 (Mk. 4; Lk. 8); 14:24, 30. II Pet. 2:17, "These are waterless springs and mists driven by a storm." Jude 12, 13, ". . . waterless clouds, carried along by winds; fruitless trees in late autumn, twice dead, uprooted; wild waves of the sea, casting up the foam of their own shame; wandering stars for whom the nether gloom of darkness has been reserved for ever."

God is often connected with the wind, as in Heb. 1:7; John 3:8; as being His breath, Isa. 40:7; and controlled by Him, Ps. 107:25; Prov. 30:4; Isa. 59:19 (as moving the wind); Ezek. 37:9; Amos 4:13, "For lo, he who forms the mountains, and creates the wind;" Mk. 4:41. Sometimes the wind is represented in connection with the four corners of the earth as in Jer. 49:36; Dan. 7:2 and Rev. 7:1.

Euroclydon was the name for the wind of typhoon intensity mentioned in Acts 27. Sometimes a north wind brought rain, (note Job 37:9). A south wind, sometimes called the "sirocco" wind, blowing in off of the dry Negeb,

sometimes brought undesirable results as in Job 37:16-17; Jer. 4:11; Lk. 12:55. Acts 27:13, "The south wind blew gently" was probably not from the Negeb. Isa. 21:1, "... as whirlwinds in the Negeb sweep on, it comes from the desert, from a terrible land." Zech. 9:14, "Then the Lord will appear over them . . . and march forth in the whirlwinds of the south." Isa. 40:24 speaks of a wind, or a whirlwind, perhaps of this direction.

Acts 13:4, 13; 14:26; 20:3, 6, 13-16; 21:1-6; 27:2ff., speak of the wind in connection with sailing.

Rain is important, together with its other forms as dew, frost, hail or snow. As mentioned, temperatures varied, from the cool breezes up by Mt. Hermon to the hot wind of the southland. This caused much of the moisture received to dry up. Most of the land was parched by the time of the early rain in late fall, and many of the brooks were seasonal. It is not without reason that about 70 ancient sites in the land have the word 'ain' which means "spring" in them, while over 60 have the word bir (beer) which means "well" in them. Most of the rain came in the winter months (perhaps better known as the rainy season). Amounts varied from about 15" up to 30" at Mt. Carmel and along the seacoast, the Judean, Galilean and Transjordan mountains. But to the Jordan valley, the Negeb, the Beersheba area, and parts of the highlands of the Transjordan, rain came less frequently, varying from 8-12" yearly. Jericho, with its 100 degree plus weather in the summer, was very dry, and much irrigation was needed, and wells dug.

Early rain was welcome. It brought cooler weather, and land moisture. Note Deut. 11:14. Ezra 10:9-13 has a cold early rain. Job 29:23; Joel 2:23, "... for he has given the early rain for your vindication, he has poured down for you abundant rain, the early and the later rain, as before." The later (latter) rain came in early spring

GOSPELS INTRODUCTION

as needed by the crops, etc. See Amos 4:7; Hos. 6:3, ". . . he will come to us as the showers, as the spring rains that water the earth;" James 5:7. God did not cause rain to come in the Garden of Eden apparently, though dew was provided, and rivers were there, so that it was well-watered, Gen. 2:5-6, 13:10. God often gave rain, though men did not deserve it, Mt. 5:45; Acts 14:17. Note here James 5:17-18; II Pet. 2:17.

Wells were mentioned early, and were always needed. See Gen. 26; 29; 30:38ff.; 37:24; II Sam. 23:15-16; II Kings 19:27; Song of Solomon 7:4; John 4:6ff. Jacob's well is still in some use. King Hezekiah used the Gihon spring for water. The rock-cut tunnel is yet to be seen. See II Kings 20:20; II Chron. 32:4, 30. It is approximately 1,777' long (1,090' over a straight line) and 6' high, the width varying down to 20" in places. David may have taken ancient Jebus via a water tunnel such as this, II Sam. 5:7.

Snow is not of frequent occurrence, but some occurs. Snow-fed streams are perhaps implied in Jos. 3:15; Judges 5:21; which became dry in the summer, I Kings 17:7; Job 24:19; Joel 1:20. Consider also Ps. 126:4 about the water courses in the Negeb. Prov. 25:13 speaks of the cold of snow in the harvest season, and 31:21 speaks about the wise woman who is ready for the snow. The cold water in Prov. 25:25 and Mt. 10:42 perhaps implies snow-fed springs, etc. Note II Sam. 23:20; I Chron. 11:22; Prov. 26:1; Job 9:30; 38:22; Ps. 147:16-17.

Springs were welcomed, and coveted for good water. Elisha made a bad one good, II Kings 2:19-22; Ex. 15:22-25. The men of Israel "stopped every spring of water" in Moab, II Kings 3:25. Isaac's servants dug into a "well of springing water" in the valley of Gerar, Gen. 26:19.

Dew was apparently the first method of watering the earth, Gen. 2:5-6. God questioned Job about it in Job

38:28, for He was considered its source, Gen. 27:28; Deut. 33:28; Haggai 1:10; Zech. 7:12. Approximately 250 days have dew in the area along the sea shore around Gaza. Mt. Carmel has 100-150 days, as does the Judean highlands but very little occurs in the Jordan area.

Sometimes it is enough for some farming as in the Negeb, or as for Gideon's fleece, Judges 6:36-40. We may be like dew or mist, James 4:14, in life or in speech, Deut. 32:2. See I Kings 17:1, 7; James 5:17-18 and Elijah. It may come gently, or at night, Deut. 32:2; Job 29:19; and be discomfoting, Song of Sol. 5:2; Dan. 4:15, 23-25, 33.

Rain and hail sometimes created problems, even as they do now, though welcomed at other times, II Sam. 5:20; I Kings 18:41, 45; Ezra 10:9, 13; Job 24:8; 37:6; 38:25-26; Ps. 32:6; 78:47-48; Isa. 28:2; Dan. 9:26; Nah. 1:3, 8.

Showers came and went, though needed, as in Deut. 32:12; Ps. 65:10; 72:6; Jer. 3:3; 14:22; Mic. 5:7; Lk. 12:54.

Rivers are mentioned many times, and are of great significance. Consider the Jordan in Josh. 3:7—4:18, 22; II Kings 2:8, 14; 5:10-14. Other important references are Gen. 2:10-13; 41:1ff.; Ex. 32:20; II Kings 19:24; Amos 7:24; Mt. 3:13-17 (Mk. 1; Lk. 3); John 3:23.

Clouds are often brought to our attention. Elijah's cloud began out on the sea, very small. Clouds coming in from the sea often disappear when the hot winds from the Jordan valley meet them at the divide which runs through Hebron, Jerusalem, Sychar up to Mt. Hermon, and then reappear when the cooler air reaches the Trans-jordan highlands. See Mt. 16:1-3 and Jude 12 for interest.

The *Seas* of the land played a part in Bible history. Lake Merom, the Sea of Galilee (Chinnerith, Tiberias) and the Dead Sea; the Mediterranean and the Red Sea all

GOSPELS INTRODUCTION

figured in the lives of Bible people. Note the state of the wicked as compared to a sea, Isa. 57:20-21. Consider Mt. 13:1ff. (Mk. 4; Lk. 8); Lk. 5:1ff.; John 21:1ff.; Acts 27:1ff.; Rev. 21:1.

JEWISH CALENDAR

<i>Month</i>	<i>Our Month</i>	<i>Festival</i>
1. Abid or Nisan Ex. 23:15; Neh. 2:1	April	14. Passover Ex. 12, 18, 19; 13:3-10 introducing 15-21. Feast of Unleavened Bread Lev. 23:6 16. Sheaf of Firstfruits of Harvest presented. Lev. 23:10-14; cf. Josh. 5:11
2. Ziv or Iyyar I Ki. 6:1, 37	May	14. Passover for those who could not keep regular one. Num. 9:10-11
3. Sivan Esth. 8, 9	May-June	6. Pentecost, Feast of Weeks, or of Harvest, or Day of Firstfruits. Loaves as firstfruits of gathered harvest pre- sented Ex. 23:16; 34:22; Lev. 23:17, 20; Num. 23:26; Deut. 16:9, 10
4. Tarmuz	June-July	
5. Ab	July-Aug.	
6. Elul Neh. 6:15	Aug.	
7. Etнанim or Tishri I Ki. 8:2	Sept.-Oct.	1. Feast of Trumpets, Nu. 29:1 10. Day of Atonement, Lev. 16:29 15-21. Feast of Ingathering or Tabernacles. First- fruits of wine and oil, Ex. 23:16; Lev. 23:34; Deut. 16:13
8. Bul or Marcheshvan I Ki. 6:38	Nov.	
9. Chislev Zech. 7:1	Dec.	25. Feast of Dedication, Macc. 4:52, John 10:22
10. Tebeth Esth. 2:16	Jan.	
11. Shebat Zech. 1:7	Feb.	
12. Adar Esth. 3:7	Mar.	14-15. Feast of Purim, Esth. 9:21-28

THE CHRISTIAN AND EVOLUTION

There are a great many divergent ideas about the position a Christian should occupy with respect to the theory of evolution. One reason is that there are over twenty various theories of evolution. Another reason is that though the Bible is an inspired revelation from God, any interpretation of it is not inspired. Thus good and honest people differ over just what God has said. Obviously, though the Bible gives some information about the creation of the universe and all therein, it is mainly given over to the story of redemption. The Bible text does not give any date for the creation of the world (the marginal notes and numbers are *not* a part of the text, and definitely not from God), so we are left without such information. We do not know for sure how much time elapsed from the creation in Genesis chapter 1 until the flood, or from the flood until Abraham. Abraham's time can be dated somewhat, but that is the best we can do. Hence, the Christian can hardly make the traditional date of 4004 B.C. an issue. The "how" of creation, the "why" and "who" might more reasonably be considered. We thus present the following article in this light. You will do well to remember that the case for or against evolution (herein presented as the alternative to creation by God, and as commonly taught in public school systems) rests on both 1) evidence and 2) interpretation of that evidence. The Bible is some of the evidence relating to "how," "why," and "who" of our universe. The evolutionary theory considered is variously known as organic or atheistic evolution. We recognize that the evolutionary positions held in the classrooms are often "ahead" of what is in the books advocating it, but the basic evidence and presuppositions are the same for the people who hold the theory of evolution to be true. Thus the following article is

intended to be generally useful, regardless of what particular theory of evolution is taught.

We have added a list of books which have either been quoted in the article, or are useful for those who want to read about the theory, or both.

THE MESSAGE OF THE BIBLE

1. *Genesis 1 speaks vividly of creation by God.*

Evolutionists say there need be no "god." Julian Huxley in *Evolution in Action*, (hereafter referred to as Huxley) says, "To postulate a divine interference . . . is both unnecessary and illogical" (page 20). Consider in this respect Psalms 33:6, "By the word of the Lord the heavens were made, and all their host by the breath of his mouth," and verse 9, "For he spoke, and it came to be; he commanded, and it stood forth."

The alternative to God is chance. However, science, as such, depends for its very existence upon this fact: we have enough of the universe to study that we may draw general conclusions. Our present conclusions are that every effect has some cause. We may be unable to ascertain the cause, but that it has one is as sure as our own experience tells us we exist. It has been an accepted fact for hundreds of years, at least in some areas of thought, *ex nihilo nihil fit*, "from nothing, nothing comes to be." As Crawford, (*Genesis, Vol. I*), well remarks, "If there had ever been a state in which there was nothing, then that state would have continued forever" (page 135). That the universe exists is undeniable if we assume the reality of our sense perceptions. Do we then have something beginning without an adequate cause? Do we postulate "no god" in spite of the effects we see about us? For instance, the universe has either existed always or it has not. No third view is possible. The consensus of

opinion is now and has generally been that it had a beginning. In fact, to say it is so many years old assumes a beginning. Nothing can be old without a beginning. We assume from experience that in every cause there is at least as much reality as we see in the effect, for if this were not so, we should have some of the effect coming from nothing. David Hume argued that people were stupid to assume causality. His problem was the confusion of two things: the difference between recognizing that every effect has a cause (even though we may not know it) and every effect has an immediate, observable cause.

The Bible asserts that God is an adequate cause for the effect we know as the earth, and the earth is not the result of chance. R. E. D. Clark, in *The Universe, Plan or Accident* (hereafter referred to as Clark), tells us that the noted evolutionist A. I. Oparin, argued that the chance argument as applied to the origin of life really undermines science (since science depends for its existence upon uniformity of the universe) so that it cannot be maintained, (page 34). Blum, in *Time's Arrow and Evolution*, (hereafter referred to as Blum), writes, "I do not see, for example, how proteins could have leapt suddenly into being. The riddle seems to be: how, when no life existed, did substance come into being which today are absolutely essential to living systems yet which can only be formed by these systems? It seems begging the question to suggest that the first protein molecules were formed by some more primitive 'non-living system', for it still remains to define and account for the origin of that system" (page 164). He has this problem: effect without adequate cause.

We will cite Bridgman for another reason why the universe did not create itself, but had to be created by God. Morris and Whitcomb, in *The Genesis Flood* (hereafter referred to as M/W), quote Bridgman as saying, "The two laws of thermodynamics are, I suppose, accepted

by physicists as perhaps the most secure generalizations from experience that we have. The physicist does not hesitate to apply the two laws to any concrete physical situation in the confidence that nature will not let him down" (page 222). The first law simply states that the total amount of energy in any system remains the same, regardless of how it is used, or into what form it is changed. Bridgman, as other scientists, knew no exception to this principle, which is applicable to our universe. The energy in our universe had to come from somewhere since it is not a cause adequate to create itself. Out of our own experience, we know that we did not create ourselves, nor were any of our ancestors capable of so doing. We also observe and know that any other matter in the universe is not able to do such. This leaves some needed source adequate to the effect. God surely qualifies.

The second law, also known as the law of entropy (for more explanation of these, read M/W, pages 222ff.; the *Creation Research Society*, hereafter abbreviated C.R.S., quarterly for March, 1969), simply states the corollary to this, that though the amount of energy remains the same, the amount available to be used steadily decreases. It states that any ordered system tends to disorder as time passes. Thorium disintegrates into radium, and finally becomes lead. Clothes wear out, and coal burns up, etc. Enoch, in *Evolution or Creation* (hereafter referred to as Enoch), quotes Sullivan, "We live in a wasting universe. One of the least disputable laws of physical science states that the universe is steadily running down" (pages 10-11). Huxley writes, ". . . the only over-all tendency we have so far been able to detect is that summarized in the Second Law of Thermodynamics—the tendency to run down" (pages 11-12). Blum: "In no case do we find controversion of the second law of Thermodynamics if we enlarge our view enough" (page 206).

William Overn, *Bible-Science* newsletter, December 1969, remarks, "Random processes produce random results," and "Every reaction is accompanied by a rise in entropy." The sun provides us with energy, but it burns up 250 million tons of matter each minute doing so. We ultimately use up that energy and turn it into such a state that it cannot be reused, at least by present known methods. Now, if we run this "burning up" back, we will soon arrive at a necessary starting point, when the sun had 100% energy available. How did that energy get there? Did God supply it?

2. *Genesis 2:1 speaks of a finished creation.*

The Hebrew word for finished means *finish, accomplish, destroy* (utterly), or *make clean riddance*, according to Strong. See Exodus 39:32; 40:33 and I Kings 6:38 for other uses of the word.

Hebrews 4:3 speaks of God's works as finished (having come into being) from the foundation of the world. God rested from all His works, verse 4, for the rest was real (an actuality). He did not need to continue creating but rather sustaining what he had created (John 5:17; Hebrews 1:3).

Evolutionists speak of a "continuing creation" (cf. Fred Hoyle, *Frontiers of Astronomy* 1955; *The Nature of the Universe* 1960) and the process of evolution going on to new and greater heights. So these men say things are happening which the Bible says are not! As R. E. D. Clark points out, "Continuous creation does not avoid creation; it merely spreads it liberally over the whole of space and time" (page 37). What he means is this: to postulate continuous creation simply sidesteps the problem of cause, and also contradicts the Bible. In contrast to the evolutionary theory, the Bible speaks of the earth

and heavens as growing "old like a garment" Hebrews 1:11. This means decay and disorder, not "new and greater heights."

3. *Genesis 1 speaks about each thing being created to reproduce "after its kind."*

This is the general statement by God concerning every area of life. We know of no exceptions to this rule. Hybrids such as the mule speak clearly that new species (in the sense of being able to reproduce themselves) are not possible (see Nelson, *After Its Kind*, pages 8-12). Every hybrid, if left to itself, dies out or reverts back to the original species. James Hutton (1726-1797) always pushed the principle that the "present is the key to the past." We will grant that and ask for any evidence that species naturally reproduce anything other than their own kind. (The problem of mutations, inherited characteristics and polyploidy will be dealt with under a later topic). If this were not the rule, any breeding or planting would be fraught with uncertainty. Even humans would be uncertain as to the product of a marriage. We assume and expect this rule to always be valid.

4. *Genesis 1 and 2 speak of plan and purpose in the action of God as he created.*

Revelation 4:11 says that by the will of God all things were created. This speaks of an expressed purpose in the mind of God. Consider that the universe about us gives evidence of design, of things working together as if planned that way. Huxley says, "At first sight the biological sector seems full of purpose. Organisms are built as if purposefully designed, and work as if in purposeful pursuit of a conscious aim" (page 13). Huxley will speak of apparent design and organized pattern (page 36). Though he disclaims that design is a reality, even he

recognizes that things work together. Blum says, "There seems to be an orderly relationship of things in the world we know, that may be spoken of as fitness." (Page 192)

The ability of species to adapt to a given environment could just as well indicate the fact that they were created this way as that they just happened. Our ability to make use of the environment around us simply says that we were created with this capacity. On page 12 Huxley says, "The proteins, the most essential chemical constituents of living substance, have molecules with tens or even hundreds of thousands of atoms, all arranged in patterns characteristic for each kind of protein. Each single tiny cell has a highly complex organization of its own, with a nucleus, chromosomes, and genes, and other cell organs, and is built out of a number of different kinds of proteins and other types of chemical units, mostly large and complex. But that is only the beginning, for large higher mammals such as men and whales may have in their bodies over a hundred million million cells of many different types, and organized in the most elaborate patterns." This sounds like purpose and plan, doesn't it? Hand in *Why I Believe the Genesis Record* (hereafter referred to as Hand), quotes Dr. George Washington Carver of Tuskegee Institute as saying, after analyzing a cabbage leaf, "There, gentlemen, is the limit of human wisdom. The chemist can separate a cabbage leaf into its component parts, but only God can take those parts and make a cabbage leaf" (page 25). (Consider the whole book called, *Wonders of Creation* by Harold W. Clark as he presents evidence for plan and purpose in the universe.)

5. *Genesis 1 and 2 speak of only six days involved in the creation of the world.*

Julian Huxley says that the universe is about 5 bil-

lion years old and that we have had life for about 2 billion years (page 21). He therefore considers that we have needed at least 2 billion years to produce life as we know it. Blum says, "The origin of life can be viewed properly only in the perspective of an almost inconceivable extent of time" (page 151). Again, he says on page 153, "No matter how the problem of the origin of life is approached, it seems necessary to admit that some events may have occurred which would appear highly improbable if viewed in our customary frame of experience."

We do not presume to say how old the earth is, but why must we take the picture for creation as painted by Genesis 1-2 to be longer than the six days stated? At first reading, the account simply says that six days were all that were needed. You may argue about the fact that the seventh day is not spoken of as being finished, but the six days were definitely finished.

If God is capable of creating the world out of nothing (Hebrews 11:3), then I assume that he could also create it instantaneously, and not even take six days to do it. How big is your God? Why do you think that the days in Genesis have to be more than 24-hour days? Is it because the sun does not appear until the fourth day? Who said we had to have a sun as we know it to have days? This was Thomas Paine's argument in his book, the *Age of Reason* and given as evidence that the Bible record was not believable. The Bible text does not say that the sun was not present until the fourth day, but rather that God placed it in the heavens that day. Besides, light and darkness had existed since the very first day. George Howe C.R.S. quarterly, September, 1969, says that study of day 3 of Genesis 1:11 shows that the vast geologic ages are impossible. If there were epochs of geological time and the purported geologic column is reasonably correct, there could be no one age of plant creation, for such reasons

as these: (1) Fossils of blue-green algae are known from Cambrian and Precambrian formations. (2) Then according to the uniformity assertion, land plants appeared later in the Silurian and Devonian times. (3) Seed plants arrived millions of years later in the Permian and Triassic ages. (4) Flowering plants came on the scene only during the Cretaceous, which is supposed to have come millions of years later than seed plants. So plant creation spans the whole of geologic time (page 92).

Morris, in *Studies in the Bible and Science*, points out that the Bible states that all plants and such as fruit trees were made on the 3rd day, while fish and other marine organisms were created on the 5th day, but geology reverses this order. He says that the Bible states that birds were created on the same day as fishes, but paleontology teaches that birds were evolved from fishes, and that insects were supposed to have appeared very early and reached their greatest development during the Carboniferous period, which preceded the appearance of the reptiles, birds, and mammals. How could the present ecological niches be filled with such an arrangement? He also states that according to the Bible, woman was made out of man, but paleontology must insist that male and female of all sexual species must have existed simultaneously (pages 33-34).

Again, assuming the present is our key to the past, the world as we know it now could not have existed for millions of years without the sun, nor could much plant life have existed without animal life. The reasons are these: plants convert the sun's energy (in the process called photosynthesis) into usable material for animals. But the corresponding process of respiration by animals is needed to convert what the plants need to function adequately. It seems to me that days must have been literal from the very necessity of the case.

Consider that in Exodus 20:11, the Bible states that "in six days the Lord made heaven and earth . . . and rested the seventh day." Do you think that the word "day" has two meanings here? A good hermeneutical principle is that the word used to mean one thing in a given context, if used again in that context, should mean the same thing, unless it is used as a pun, etc. Actually, the whole context of Exodus 20:8-11 is talking about literal 24 hour days. The word "day" appears approximately 396 times in the 5 books of Moses. Except Genesis 32:24, it is the translation of the Hebrew word "yom." How did Moses mean for us to understand it? Does Genesis 2:4, and 2:17 demand we understand the word as something other than 24 hour days? And if so, that we must do so any other place? If you say that the 7th day is not stated to have ended, that is simply an argument from silence, and not very strong as such. Besides, the first 6 days are definitely stated to have ended. That settles the matter for them.

6. *Genesis 1 speaks of God as the source of life.*

There are many other references in the Bible to this fact, as John 5:21, 26; Exodus 12:7. It is a well accepted scientific fact that spontaneous generation is not true, and the law of life from life (biogenesis) is true. Huxley says, "The work of Pasteur and his successors has made it clear that life is not now being spontaneously generated" (page 19). Lorande Woodruff writes, "We thus reach the general conclusion that, so far as observation and experience are concerned, no form of life exists today except from pre-existing life."

J. D. Thomas, in *Facts and Faith* (hereafter referred to as Thomas), quotes Harlow Shapley, Harvard physicist, as saying that we can not use "principles unknown or

unknowable to science" to solve the principle of origins (page 127). But such they do, for Shapley himself speaks on page 9 of *Science Ponders Religion*, about the "apparently automatic way life emerges when conditions are right". The ones who reject God as the source of life must take spontaneous generation as the only logical alternative, and organic evolution as the only logical theory. To state it the opposite way, M/W quote George Wald, "The only alternative to some form of spontaneous generation is the belief in supernatural creation" (page 235). Nelson quotes Ernst Haeckel, "The origin of the first monera (cell) by spontaneous generation appears to us as a necessary event in the process of the development of the earth. We admit that this process, as long as it is not directly observed or repeated by experiment, remains pure hypothesis. But I must say again that this hypothesis is indispensable for the consistent, non-miraculous history of creation" (page 14). Hans Gaffon writes, "A natural scientist who wants to study this evolutionary process has no choice but to start and proceed on the assumption that the living come from the non-living. This in spite of the fact that what stares him in the eye—all life about him—is so fantastically complex that it is hard for him to believe that it truly happened" (Thomas, page 127). J. H. Rush writes, "The scientist does not expect something to come from nothing. He has a dogged conviction that, if an explosion occurred, something must have been there to explode" (Rita Thodes Ward, *In the Beginning*, page 17). Sir Arthur Keith said, "Evolution is unproved and unprovable. We believe it because the only alternative is special creation, which is unthinkable" (Enoch, page 105). Yet Lord Kelvin thought that "Science positively demands creation" (Enoch, page 94). M/W again quote Wald, in a discussion of the great complexity of even the simplest organism, and the great odds against such even happening

or arising from non-living systems, "One has only to contemplate the magnitude of this task to concede that the spontaneous generation of a living organism is impossible. Yet here we are—as a result, I believe, of spontaneous generation" (page 234).

The origin of living matter is yet a mystery. Scientists now think that DNA is the secret of life, but the opposite is true, for life is the secret of DNA. Besides, DNA is the servant of the cell, not vice versa. We can put the ingredients of a kernel of wheat together, but there is no life there. A. D. Wilder Smith, in *Man's Origin, Man's Destiny*, (hereafter referred to as Wilder-Smith), quotes Dixon and Webb, "To say airily, as some do, that whenever conditions are suitable for life to exist life will inevitably emerge, is to betray a complete ignorance of the problems involved" (page 13). To say that conditions will be right for life to appear is to ask for exceedingly complex conditions. Only planned experiments in highly sophisticated laboratories will even allow the production of an amino acid, which is a long ways from a living cell, or anything like it.

Some would say (as mentioned before) that given enough time and the right combination of matter, life will arise. Perhaps, but some are not as credulous as others. Clark, in *Darwin, Before and After*, mentions that the eleven brothers of Joseph had not heard of the "laws of probability, of entropy, or of the second Law of Thermodynamics," but when they were seated in proper order, they all marveled (Gen. 43:33) and rightly guessed that the "long arm of coincidence would hardly have arranged them that way" (page 149).

We rule out chance! Even the word "chance" does not mean what it seems. Darwin postulated natural selection and survival of the fittest to circumvent chance. Huxley says, "Natural selection converts randomness into

direction, and blind chance into apparent purpose" (page 47). But Clark quotes Darwin as saying that "I should infer from analogy that probably all the organic beings which have ever lived upon this earth have descended from one primordial form into which life was first breathed by the Creator" (page 61). Even Darwin couldn't get away from the realization that things do not happen. They are caused! It is quite naive to assume with Pierre Tailhard de Chardin that "our earth is an unbelievable accident" (Wilder-Smith, page 89). What does "unbelievable" imply?

THE MESSAGE OF THE EARTH

7. *The earth says: Do fossils prove anything necessarily?*

Some evolutionists say that the earth simply happened through the avenue of chance. That life simply occurred when conditions were right. Assuming this premise for the sake of argument, we could assert the same thing about fossils could we not? That they are simply fortuitous concourses of atoms? Thus, simply proving that fossils prove nothing about past life.

We do not assume the premise of evolution, however, but we do assert fossils give evidence that 1) life is subject to the II Law of Thermodynamics, 2) some life has not always existed as it does now, and 3) the missing links are still missing.

Before we discuss any further, we would point out that the extant fossil remains of mammals are almost all confined to the Cenozoic era. William Gregory is quoted by Klotz as saying that all the fossils we have from the Mesozoic era could be put in a small box, since they consist almost entirely of tooth and jaw fossils. (*Genes*,

Genesis, and Evolution, hereafter referred to as Klotz, page 212).

The second law says decay is the rule. We tend to disorder. Death is the inevitable result of decay and disorder. This is as God ordained it. Often evolutionists say that the II Law of Thermodynamics applies to all systems except the specialized one of evolution since evolution supposedly tends to more order. Blum says, "There is no reason to think that evolution controverts the II Law of Thermodynamics, even though it (evolution) may appear to do so if viewed as a thing apart" (pages 200-201). His conclusion about evolution not being subject to the facts of the II Law: it just seems to be that way. The end of life just simply says that we have decayed, and the system no longer works as it once did.

We stated that some of life is different now than it used to be. It is also true to say that fossils show that some life is identically the same as it used to be. (We refer you to chapter 16 of *Geology Made Simple*, Wm. Matthews III, Doubleday & Co., for examples of life in the past ages.) For instance, we have leaves from the Ginko (or Gingko) that come from the Jurassic Epoch, several varieties of starfish from the Ordovician Epoch, a grape leaf and a walnut leaf of the Cretaceous Epoch, a hickory leaf from the Pliocene Epoch, a Japanese Oak leaf from the Eocene Epoch, and all of these are identical with their descendents of today (see Nelson). We have an ant preserved in amber that is the same as ants of 50 million years ago in the Eocene Epoch, Australian lungfish over a 150 million years old from the Jurassic Epoch, a seashell called *Lingula* from at least the Ordovician Epoch, an oyster from at least the Permian Epoch, a common opossum from the Mesozoic Era, all of which are the same as their descendants of this day (see Huxley pages 111-112). M/W have a picture of a Tuatara, a reptilian order of

beakheads, that is identical to fossils of 135 million years ago. They also mention a recent discovery of a deep-sea mollusk very much like the long-extinct Trilobites of the Cambrian Epoch, and each of these gives evidence that some things are the same today, according to the fossil record, as they were ages ago. Cook is quoted, "Sponges, echinoderms, mollusks, and worms formed already in these immeasurable remote ages, are groups as generally distinct from one another as they are at the present time. The fact is, there is no fossil evidence for evolution of invertebrates; they all appear suddenly, and fully specialized" (Enoch, page 47).

Blum states, "Fossil representatives of most of the major groups of existing forms of life were present, although the Chordates (the phylum including the vertebrates and man) and all the higher plants were conspicuously absent. Even in the earliest of the Cambrian rocks, a majority of the existing phyla are represented by forms which may be readily grouped alongside modern ones" (page 151).

Rimmer, in *The Theory of Evolution and the Facts of Science* (hereafter referred to as Rimmer), lists Silurian coral and algae, carboniferous crayfish, ferns, and palms and grasshoppers like their present day descendants; moss agates (a variegated chalcedony) whose age is unknown (one of which he knew to contain a mosquito); ancient conifers, and other things like present species known to us. (He mentions fossil dragon flies with a wingspread of 18 inches!—pages 80-95).

From these quotes we conclude that some life, according to the fossil record, (even assuming the geologic column normally presented as factual) has not changed at all. Tinkle, in *Heredity, A Study in Science and the Bible* (hereafter referred to as Tinkle) writes, "The general course of development is claimed to proceed from

THE CHRISTIAN AND EVOLUTION

simple to complex, as all biologists know, an optimism which is quite at variance with genetics, with physics, and with the Word of God" (page 163). (See also, in this aspect of simple to complex, Clark's chapter entitled, "One Way Traffic in Physics.")

With respect to homo sapiens, and the fossil record, we find such statements as this one by Mr. Short. He says, "The most unexpected part of the paleontological evidence, however, remains to be mentioned; the further back we look for early man, the more like ourselves he appears to be" (Hand, page 67). Hand points out (see also, Klotz, pages 198-199) that a wrestler of our own generation named "The Angel" had a skull like the Neanderthal Man. The shape of his skull was caused by a rare childhood disease called acromegaly. Is this skull and the cause of it any evidence for the few skulls of the Neanderthal man we have?

Reader's Digest of April, 1960 contains an article by Ivan T. Sanderson entitled "The Riddle of the Quick-Frozen Mammoths." In it, Sanderson graphically describes real mammoths quick-frozen in regions of Siberia and Alaska. These mammoths are as large or larger than any of the present day elephants. Besides, a great variety of other animals are also buried there, such as giant bison, wolves, beaver, woolly rhinoceroses, giant oxen and huge tigers. Not only do these point out vividly that life has not always been like it now is on earth (thus, making the uniformitarian assumption glaringly untrue) but that much of it was bigger. We have yet to mention the dinosaur family, and other varieties of such life as those creatures.

Reader's Digest of January, 1964, had the article about the Leakey's finds in the Olduvai gorge in east Africa. They describe the life that was contemporaneous with their celebrated Zinj, and write, "The evidence uncovered

at Olduvai also gives us a bemusing picture of the huge beasts that everlastingly surrounded Zinj., extraordinary creatures long vanished from the earth. The fossil harvest has yielded the remains of more than 100 prehistoric Titans. The remains of a pig as huge as a hippopotamus, with tusks so long that one scientist mistook them for an elephant's, were found there." They mention a "giant sheep which measured six feet at the shoulder with horns 15 feet across and as strong as a steel beam. Towering over the bird family was a tremendous ostrich, almost two stories high, which must have laid eggs as big as bowling balls".

We know that the Cro-magnon man was as large or larger than present day humans, with a cranial capacity as large or larger than ours (Wilder-Smith, page 134). These early humans existed at the same time as the Neanderthal men for their skeletons have been found together in caves on Mt. Carmel (Tinkle, page 105).

From these quotes we conclude that some of the life we see around us today is quite unchanged from any found in the fossil record. We also note that there were definitely animals that existed then much larger and in varieties not even now known. What about these facts? Do they tell a story about the validity of the 2nd Law of Thermodynamics? Not only that death occurs, but that life goes downhill—rather than uphill which evolution claims. We simply do not find in the fossil record any evidence of species transmutation either. Hand quotes Charles Darwin, "As by this theory innumerable transitional forms must have existed, why do we not find them embedded in countless numbers in the crust of the earth? Why is not all nature in confusion, instead of being, as we have them, well-defined species?" Why, indeed? He again quotes T. H. Morgan, "Within the period of human history we do not find a single instance of the transforma-

tion of one species into another one. It may be claimed then that the theory of descent is lacking in the most essential feature that it takes to place it on a scientific basis" (page 27).

Do we have any particular reason to think there are links between the species if organic evolution is not true? We should find all the species clearly defined, and such is the case. Frank Marsh, *C.R.S.* annual, June 1969, quotes G. G. Simpson as saying, "In spite of these examples, it remains true, as every paleontologist knows, that most new species, genera, and families appear in the record suddenly and are not led up to by known, gradual, completely continuous transitional sequences." And Alfred Romer, "'Links' are missing just where we most fervently desire them, and it is all too probable that many 'links' will continue to be missing". And Norman Newell, "Experience shows that the gaps which separate the highest categories may never be bridged in the fossil record. Many of the discontinuities tend to be more and more emphasized with increased collection" (page 17). He also tells us Theodosius Dobzhansky, well known zoologist at Columbia University, told him that we could not expect to prove from present plants and animals that mega-evolution (transmutation) had occurred, and that for such evidence, the fossil record was the only answer. We already see that there is no answer for their hopes there. Silence shouts loudly that the missing links are conspicuous by their absence.

The horse family should now make its appearance, since they are the real proof that evolution has occurred, at least according to evolutionists. (We highly recommend the article in the November issue of *The Plain Truth* entitled, "Evolution gets the Horse Laugh," by Paul Kroll, for plenty of evidence that horses prove no such thing.) The book, *Zoology, An Introduction to the Animal King-*

dom, published by Golden Press, states, "The fact of evolution is incontrovertible" (page 143). They then state that the horse family fossils prove this to be so. But the story is not yet all told. G. A. Kerkut, in *Implications of Evolution*, (hereafter referred to as Kerkut) writes, "The evolution of the horse provides one of the keystones in the teaching of the evolutionary doctrine, though the actual story depends to a large extent upon who is telling it and when the story is being told. In fact, one could easily discuss the evolution of the story of the evolution of the horse" (page 145). He states that in 1874 the number of genera of horses was known to be 3, by 1917 it was 15, but by 1945, G. G. Simpson listed 45 in his book, *Horses* (page 148). We would wonder why the 5 fossils (eohippus, mesohippus, merychippus, pliohippus, equus, W. W.) are then presented as if these were the only ones? He goes ahead then to point out what is not taught in textbooks, that "At present, however, it is a matter of faith that the textbook pictures are true, or even that they are the best representations of the truth available to us at the present time. One thing concerning the evolution of the horse has become clear. The story of the evolution of the horse has become more and more complex as further material is collected, and instead of a simple family tree the branches of the tree have increased in size and complexity till the shape is now more like a bush than a tree. In some ways it looks as if the pattern of horse evolution might be even as chaotic as that proposed by Osborn (1937, 1943) for the evolution of the Proboscidea, where 'in almost no instance is any known form considered to be a descendent from any other known form; every subordinate grouping is assumed to have sprung, quite separately and usually without any known intermediate state, from hypothetical common ancestors in the Early Eocene or Late Cretaceous.' (Romer, 1949). In the

THE CHRISTIAN AND EVOLUTION

first place it is not clear that Hyracotherium was the ancestral horse. Thus Simpson (1945) states, 'Matthew has shown and insisted that Hyracotherium (including Eohippus) is so primitive that it is not much more definitely equid than tapirid, rhinocerotid, etc., but it is customary to place it at the root of the equid group . . .' It is quite likely that further studies will show that the complexity of horse evolution will prove to be as great as that found in the Proboscidea, Rhinocerotidea, or Camelidea" (Pages 148-149).

Rimmer emphasizes that the 5 fossils of eohippus, mesohippus, merychippus, pliohippus, and equus are not all found on even the same continent, let alone in the same consecutive pile of rocks somewhere. He says that one fossil ancestor with 4 and 3 toes had been found, but it weighed something like 3 tons, and so was accordingly left out. In describing eohippus, he quotes a bulletin from the American Museum of Natural History, "The proportions of the skull, the short neck, and arched back, and the limbs of moderate length, were very little horse-like, recalling on the contrary, some modern carnivorous animals, especially the Civets (Viveridea). The teeth were short-crowned and covered with low rounded knobs of enamel, suggesting those of monkeys and of pigs or of other omnivorous animals, but not at all like the long crowned complicated grinders of the horse" (pages 110-111). He also mentions two fossil horses that lived at the same time as their so-called ancestry, eohippus, and known to science today. The names are Equus nevadensis and Equus occidentalis, both of which were contemporaries. The last horse was a native of the western United States, whose fossils are found in profusion (page 112). The reason these are never mentioned is that they complicate the picture considerably, as Kerkut pointed out. In the article from *The Plain Truth*, mentioned before, Kroll

writes, (quoting Simpson), "No one even suspected at that time (of the discovery of what is called eohippus, W. W.) these were ancestral horses. How could they? The specimens found by Colchester and Richardson had almost no special resemblance to the living horse. The teeth, instead of the great, ridged, grinding prisms of our present horses, were small, low, and cusped, really more like monkey teeth than horse teeth. The little skull . . . looked (as its first describer, Richard Owen, remarked) rather like 'that of the Hare or other timid Rodentia'. From the evidence then available, it would have been most unscientific to jump to the conclusion that this queer little beast was a sort of a horse. Owen named it Hyracotherium" (page 26). Then if such were so, why now call it a horse? Kroll tells us, however, why it is now called a horse. Simpson is quoted from pages 147-149 of his book thusly, "Owen compared the small Eocene mammal with the Hyraxes . . . which, indeed, it resembles more than it does the recent horses. When much later, similar fossils were found in the Eocene of North America, the principle of evolution had been well established. Professor Marsh was therefore able to recognize that these fossils were horse ancestors, and he coined for them the apt and euphonious name Eohippus, 'dawn horse,' referring to the fact that they occur in the Eocene . . . epoch." So it took a theory to set the horse straight! Yet this horse has no teeth, head, body, or feet like a horse, and rather looks like a kind of cat. In fact, Time Life's book, *Evolution*, says on page 112 that eohippus was a small animal about the size of a domestic cat. We think Kroll's article is well entitled, don't you?

The fossil record is just not convincing, and it is supposed to be. Enoch quotes T. H. Huxley, "If evolution has taken place, there (on the rocks, W. W.) will its mark be left; if it has not taken place, there will be its

refutation" (page 51). Besides the quotes in the earlier part of this point, consider that "The geological facts flatly oppose it (evolution). For all the great groups of creatures, all the most highly specialized types, appear suddenly and in full efficiency from the first, there being no links between the phyla, classes, or even orders. In other words, links are entirely missing just where, on the Darwinian theory, they should be most numerous" (Davis, quoted by Enoch, page 45). M/W quote Heribert-Nilsson, "It has been argued that the series of paleontological finds is too intermittent, too full of missing links to serve as a convincing proof. If a postulated ancestral type is not found, it is simply stated that it has not so far been found. Darwin himself often used this argument and in his time it was perhaps justifiable. But it has lost its value through the immense advances of paleobiology in the twentieth century . . . The true situation is that those fossils have not been found which were expected. Just where new branches are supposed to fork off from the main stem it has been impossible to find the connecting types" (page 129).

Wilbert Rusch in the C.R.S. annual, May, 1969, says that the fossils of man such as Australopithecus, Java man, Neanderthal, Cro-magnon, and other supposed ancestors of man can no longer be considered as the oldest known relative of homo sapiens. The reason is that older remains have been found, and yet they are like modern man (as previously pointed out). Dr. Leakey, after finding Zinjanthropus, and calling him a missing link, later found another fossil over 300 feet down, and called him Homo Habilis. But this find caused him to say that this fossil would cause all the books on Anthropology to be written over, even his, since this fossil was so much like man (page 14).

The supposed link between birds and reptiles, Archaeopteryx, is claimed to be such though we have only 3 fossils found, and no one knows whether it could really fly or not, even though it has feathers like a bird. The little booklet, *Evolution, Science Falsely So-called*, points out that the many large feathers show that it was a warm-blooded creature, and fully capable of flight, with a typical bird-like skull and the feet of a perching bird. The feathers were definitely not frayed-out scales. This is what evolutionists claim to have happened of course, that scales became feathers. But scales are from a different layer of skin than feathers, and are basically different. Feathers go with birds as hair does with animals. Turner states, "The single supposedly prehistoric flying lizard Archaeopteryx is no more a link between cold-blooded reptiles and warm-blooded birds, than bats are links between birds and mammals" (page 30; see also Enoch, page 51).

The only thing we have not discussed is the geologic column. It is the purported series of rocks which have been claimed to contain the fossils of the life on the earth since its beginning. The earliest rocks said to contain the simplest life are the Cambrian, and so on up the column. The student can find the names and years each era, epoch, etc. represents in most any geology book, or other places of like nature. Suffice it to say that the rocks are not found in any clear order anywhere, without the same type rocks being found out of order other places. Nelson lists on pages 66-67 of his book a great number of places where the rocks are definitely out of order, if the evolutionists' column be factual. M/W list and show pictures on pages 180-211 of tremendous areas of rock and earth that are "out of order." The student ought to recognize that the rocks in point are sedimentary rocks, laid down by water processes. If this is so, how do we know that

the rocks were laid down as the column says they were, by processes over millions of years, and not rather in a flood as the Bible describes? Considering the vast areas of land that are not in order, and which are said to have gotten that way by some great upheaval of the earth, (the words "fault, thrust, folding," etc. are used to describe these events) the Bible catastrophe is not out of the ordinary at all, for magnitude. The previously mentioned article by Sanderson postulated catastrophic conditions on a scale equal to that of the Genesis flood, to say the least. The Bible flood could answer a lot of questions about great fossil beds the world over, and marine life found in tops of mountain ranges, etc. The student should read the section in M/W about the way fossils are formed, pages 154-169.

The next important thing to note about this theoretical pile of rocks is that such a stack is not to be had anywhere. Von Engeln and Caster state that "If a pile were to be made by using the greatest thickness of sedimentary beds of each geologic age, it would be at least 100 miles high . . ." (M/W, page 106). It is almost needless to say that no such pile is around. The Grand Canyon is approximately 1 mile deep, and that is a long ways from 100 miles. So that is a theory of thin air, wouldn't you say?

The final note here is that the way the column is made is to assume the theory of evolution and then build the column from that. Schindewolf writes that "The only chrometric scale applicable in geologic history for the stratigraphic classification of rocks and for dating geological events exactly is furnished by the fossils . . . they offer an unambiguous time scale for relative age determinations and for world-wide correlation of rocks" (M/W, page 132). Many other quotes could be given which say the same thing. The point to be made is this: If evolution

is not true, then who is to say that any rocks are out of order, or what the order should be, if there is any order?

We think the fossil record tells us clearly that the II Law of Thermodynamics is and has been true for all of matter, that the present is not the key to the past, and that the missing links will always be "A.W.O.L." from the evolutionist's point of view, for the simple reason that organic evolution is a monstrous fraud. We do not argue with the fossils that have been found, only with the interpretation of them. The fossils cannot tell us about any relationships, since they are dead. We can just conjecture. Clark quotes D'Arcy Thompson as concluding that the great organizational gaps in evolution are today unabridged and likely to remain so forever (page 157).

8. *The earth says: I may not be as old as I appear.*

Appearances may be deceiving sometimes. The statement by Julian Huxley (page 11) that the earth is 5 billion years old is simply an opinion required by the evolutionary theory. Blum says, "The origin of life can be viewed properly only in the perspective of an almost inconceivable extent of time" (page 151). Yet Sir Isaac Newton, sometimes considered the greatest scientist the world has ever known, thought that Ussher's date of 4004 B.C. for creation did not conflict with what he knew of astronomy (Enoch, page 43). One may reply that we know so much more now that our knowledge puts Mr. Newton to shame. "We are the NOW generation. Knowledge of all past generations is superceded by ours!" It might be well to ask, (since some almost worship scientists and their statements), does this generation of people represent the epitome of knowledge, and if whatever is known which can be known is known by us? You would do well, sometime, just to sit down and write out the number of

THE CHRISTIAN AND EVOLUTION

"assured results" of past generations, and see how many are considered invalid today. It was once thought that earth, air, fire and water composed the sum total of elements! But it was not so.

What we are trying to say is this: We do not have to agree with some of the interpretations of scientists in the fields of biology and geology, inexact sciences, and especially so, since they generally assume evolution is a reality before they begin any research or extrapolate from the facts found.

The foundation of the theory of organic evolution is really based on the paleontological finds and facts. But listen to Mr. Kerkut: "The most important evidence for the theory of Evolution is that obtained from the study of Paleontology. Though the study of other branches of zoology such as Comparative Anatomy of Embryology might lead one to suspect that animals are all interrelated; it was the discovery of various fossils and their correct placing in relative strata and age that provided the main factual basis for the modern view of Evolution. It is unfortunate that the earliest rocks to contain fossils, the Precambrian and Cambrian, already show representatives of all the major invertebrate phyla. The earliest rocks are mainly igneous and it is possible that the fossils that they once contained have since boiled away, but there is an alternative view that the invertebrates suddenly and explosively evolved and had little or no Precambrian history" (page 134). We wonder why one would only suspect relationships from any other field except paleontology, and secondly, why the plant world could or would have suddenly exploded? We also wonder why we must place the various fossils in the relative strata. Why are they not already there, without any problems, such as we mentioned in point 7?

The last point considered some of the fossils and their story. One point to be mentioned here is this: the fossils do not necessarily show the earth to be old. The only reason time is postulated by evolutionists, and substituted for energy, is that the evolution of the world demands time. But the fossils show that man could be considered as old as any other of the supposed ancestors of man. The testimony of men who have seen with their own eyes the footprints of a man and a dinosaur in the Pulaxy river bed at Glen Rose, Texas, tells us that man may be considerably older than the 60 odd million years given him, and lived during times he was not supposed to be living. George Howe in the C.R.S. quarterly of December, 1968, reports the find of William Meister in Utah of a sandal footprint with crushed trilobites in it! These are testimonies that are factual! The presence of "living fossils" may say that things either have not changed or the earth is not as old as it is said to be.

In that same issue, Howe writes, "Uniformitarians teach that woody stems are supposed to have appeared no earlier than the Devonian strata, and the origin of wood is believed—in the context of evolution—to be hundreds of millions of years old. It comes as a shock then that Melvin Cook found valid wood specimens in the Pre-cambrian strata in Canada!" Cook reports that Dorf and Blais found fossil wood that gave a radio-carbon dating of only 4,000 years but was obtained in "Late Cretaceous rubble". (Cretaceous rocks are supposedly 100 million years old.) Howe reports that conifer seed plants (like pine and spruce) are not supposed to have appeared until the Permian period, but Clifford Burdick found such in the Pre-cambrian and Cambrian series in the Grand Canyon. No land plants of any type are to have existed before the Silurian period, yet Wilbert Rusch, Sr. knows about vascular plant spores in Cambrian rocks" (page 90).

THE CHRISTIAN AND EVOLUTION

The foregoing is for one purpose: to show that there is other evidence (facts) than what we are commonly told in the textbooks, which is commonly presented with a geological column to show in what era such life arose, beginning with the simplest life in the oldest (deepest rocks) and so on. The meaning is this: unless the organic evolutionary theory be assumed as true, the rocks simply do not show what the theory assumes, as already stated in point 8. The paleontological record is also very incomplete. Klotz has a quote in the *Bible-Science* newsletter, January 1969, as follows: "Actually studying paleontology is like trying to read a 400 page novel in which most of the pages are missing. It could be likened to reading only pages 13, 38, 170, 173, 300, and 400 which are intact in the book, but the rest are missing or severely damaged. Such is the problem."

The current rage for radiocarbon dating should make an appearance here. We recommend the C.R.S. quarterly for September, 1968, which is almost exclusively given to this subject, and the excellent article in the C.R.S. annual of 1969 by Robert Whitelaw on radio carbon and potassium-argon dating. The problem for each of these methods is the assumptions with which they begin (and assumed as true by evolutionists). D. O. Acrey in the C.R.S. quarterly, January, 1965, says that "The use of radioactive decay as a basis for absolute age determination involves the premise that a parent element decays at a known rate, which remains constant, into a daughter element. The decaying mechanism is assumed in all cases to occur directly or in a radioactive chain with nothing added or removed during the process of decay. The original rock or mineral must either be free of the ultimate daughter isotope or contain this isotope in a known proportion to other isotopes so that the original content of the decay material can be ascertained." Kerkut writes, "There are

two main ways of dating rocks: an objective method of using radioactive data and a subjective method by which one analyses the relative position of the rocks and their included fossils and then comes to conclusions concerning the contemporaneity and the priority of the different strata. Neither of these methods is completely free from objection . . ." (page 137).

M/W list the following assumptions for the C-14 method. (1) The carbon 14 concentrate in the carbon dioxide cycle is constant, (2) The cosmic ray flux has been essentially constant, (3) The decay rate has been constant, (4) The dead organic matter has not been altered by something, (5) The carbon dioxide content of the ocean and atmosphere has been constant, (6) and that the rate of formation and rate of decay of radio-carbon atoms has been the same. They go on to show that even the founder of the method, W. F. Libby, discovered problems with the method. Their chapter, pages 330-453, and the articles mentioned above, will show the reader that the dating methods are indeed questionable, and quite unreliable for many reasons.

You are able to see clearly from M/W what is assumed: uniformity throughout the past ages. As James Hutton said, "The present is the key to the past." But the findings around the arctic circle as previously mentioned in point 8, just to mention one thing, point out clearly the fact that the earth has not always been as it now is (The Bible also asserts this fact.) Mr. Kerkut will write on page 137 that paleontological evidence will indicate that "bone is more primitive than cartilage and in this respect conflicts with ideas that are derived from embryological studies."

Robert Whitelaw says, "All . . . time clocks fall into two classes, the quantitative and the qualitative. Of the quantitative clocks, only two remain in scientific favor

today: the Radiocarbon method, and the Potassium-Argon method. All others involve shaky assumptions, each assumption often contingent on the previous" (page 78, *C.R.S.* quarterly, September, 1968). Whitelaw points out that the C-14 method, as worked out by Libby, gives either a date for creation of 15,000 years or 7,000 years depending on which specific production rate of carbon is used. This is a far cry from the billions of years from Huxley. The year 1850 was chosen as the normal year for use in determining the amount of carbon that should be found in any rock, etc., since it was before the Industrial Revolution, which added to the carbon dioxide and neutrons in the atmosphere. But it is a known fact that the amount of radiocarbon in the air was unstable even before this time. Therefore, this year is surely no representative of all the time elapsed until then, or now. The theory itself has proved inconclusive since the production of radiocarbon differs almost 20% from that of the present disintegration rate (which makes the initial assumptions invalid since Libby and his associates assumed they were equal for testing). The production of radiocarbon is 18.8 atoms/gram-minute, while the decay rate is between 14.5 and 16.3. This means that there is more being produced than is observed disintegrating. With this actual ratio used, the earth shows a creation date of 15,000 years. But cosmic radiation today is reproducing neutrons (and consequently C-14 atoms) at the rate of 27 atoms/gram-minute. If this is the average to be used, then creation is only 7,000 years away.

The Potassium-Argon method is essentially this: natural potassium is radioactive and its beta activity is because of the K-40 which decays, with 92% being by gamma emission, and 8% being by beta emission. This last emission has a $\frac{1}{2}$ life of 1.31 million years. Half of the K-40 would appear as Argon-40. As Whitelaw points

out, there are only two major problems. One is that a way is needed to measure the very small amount of argon trapped in the rock specimen (since potassium only has K-40 in the ratio of 12 parts to 100,000 which would leave only 6 parts in 100,000 to be Argon-40), and how to determine what part of this argon is from the potassium decay, and what part has been picked up from the earth's atmosphere (in which Argon is very plentiful, about 1% by volume, and 99.6% of that is Argon-40). Whitelaw well says that the assumption that the ratio of the K-40 of the K-36 in the air as being uniform in all ages past is a "glaring example of the blinding power of the uniformitarian faith" (page 72). One must assume that the rate of buildup from a given creation point, and that the ratio of Argon-36 to Argon-40 has always been the same. But who knows that? He says, "This then is a timeclock without hands—without even a face—upon which evolutionary faith now depends to prop up its desperate belief in a world that never began, a creation that never occurred, and a Creator who never created and no longer exists!" (page 83).

If these are the two most dependable, then we have little to consider as to their accuracy. The qualitative clocks can only indicate a greater or lesser age and cannot determine actual years. The quantitative clocks are sorely lacking, and as Kerkut says, "We have, then, as yet, no accurate objective clock that will allow us to determine the absolute age of the majority of the rocks of the world" (page 140). Douglas Dean in an article in the *C.R.S.* January quarterly of 1966, says that the Petroleum Institute of New Zealand has reported that radiocarbon dating shows that our petroleum deposits were formed from 6,000 to 7,000 years ago! He also notes that the supposed age of Dr. Leakey's "Zinj" was obtained by dating some soil samples of the rocks in which it was found,

which means nothing about the age of "Zinj" and little more about the soil, if the information about C-14 is true which Whitelaw and others present. In the same quarterly, page 31, Mr. Wiant cites a study of some wood of living trees near an airport by the radiocarbon method shows them to be more than 10,000 years old, because the wood contained so much inactive "fossil carbon" from the exhaust of airplanes.

The fossils, as before pointed out, do not give any more hope. Who can say how the fossil got where it was found? Who is to know if the tests are accurate? (Besides, as Kerkut says, fossils are the subjective method!) Enoch tells that Dr. H. C. Morton relates how some American scientists had to reduce the age of a skeleton found in the Mississippi from 50,000 years to 5,000 because they found a modern flat-bottomed boat below it (page 36-37).

We will close with this information from Morris and Whitecomb, pages 132-134. They note that geologic dating and correlation are based on two assumptions: uniformity and evolution. They illustrate it with these quotes: Schuchert and Dunbar say, "A trained paleontologist can identify the relative geologic age of any fossiliferous rock formation by a study of its fossils almost as easily and certainly as he can determine the relative place of a sheet of manuscript by looking at its pagination. Fossils thus make it possible to correlate events in different parts of the world and so to work out the history of the earth as a whole." Dunbar is then quoted as saying, "Although the comparative study of living animals and plants may give very convincing circumstantial evidence, fossils provide the only historical documentary evidence that life has evolved from simpler to more complex forms."

We simply ask: if we cannot date the rocks except by the fossils, and the fossil record has no objective evidence to offer, how do we know how old the earth really is?

THE MESSAGE OF BIOLOGY AND ZOOLOGY

9. *The Plant and Animal Kingdoms show design and purpose, not chance.*

The plant and animal kingdoms from the perspective of design and purpose show many things that should convince the non-prejudiced person that they are not the result of chance combinations. We have no real evidence that forces us to the conclusion that it just happened. If all we now know came from nothing, then how did the two kingdoms ever separate? How closely are we related to the trees, for instance? to weeds? to worms? to sheep? Consider the evidence of these two areas for creation and against evolution.

That there is a clear-cut distinction between the two is readily apparent. The general conclusion that like produces like is also true. Many different varieties of certain things (like wheat, corn, flowers) exist, but all produce "after its kind," as the Genesis record reads. From a farm background, I never knew anything else to be true, in either kingdom. Assuming James Hutton's premise, I deny evolution has even occurred, since by his premise, my present is the key to the past. The observed principle (called a law) of biogenesis is incontrovertible. I have no record of any exceptions. Yet evolutionists say that sometime in the past, life came from non-life. All you have to do is read a little book like the one from Golden Press, entitled *Zoology, An Introduction to the Animal Kingdom* to see that such is true! The book comments that "all (animals) are descendants of some primal

life which began in some oriental sea over a billion years ago" (page 4). Yet, in the very next sentence we are told, "How life began is still unknown."

Which of the two assertions shall we consider as fact? The book says that "The ancient ancestor of modern plants and animals must have been extremely simple" (page 5). We ask why? It is only so because change cannot produce anything complicated? So they assert on page 11: "The dawn of life doubtless occurred over a billion years ago in an ancient sea by some chance combination of simple materials." Now from page 22, "Protoplasm is of some of the same chemical elements found in non-living things; yet it is endowed with the unique qualities of life. It is an exceedingly complex combination of chemicals." (Consistency is a jewel, eh)? Huxley remarks, about life's beginning, "It must be confessed, however, that the actual process is still conjectural; all we know is that living substance must have developed . . ." (page 21). But is this not just stating what is obvious: life is present? That has the same force as Darwin's postulate that the fittest will survive. That is simply saying that the living are the fittest, and accordingly survived. The arrival of the fittest is the thing in question, not the fact that something is alive.

Protoplasm is made mainly of proteins, carbohydrates, fats, salts and water. Its average chemical composition is as follows: oxygen 76.0%, carbon 10.5%, hydrogen 10.0%, nitrogen 2.5%, sulfur 0.2%, phosphorus 0.3%, potassium 3%, chlorine 0.1%, and less than 1% of sodium, calcium, magnesium, iron, and several other elements. With at least 12 different elements in this list, how do we know that all were even present at the same time and place at the dawn of the world? Even if they were so, how did they get in that exact ratio to each other? John Cothran in his chapter, "The Inescapable Conclu-

sion," writes, "Consider the 102 known chemical elements and their amazing diversities and similarities. Some are colored, others are colorless; some are gases extremely difficult to liquify and to solidify; . . . Yet, with all this seeming complexity, all conform with the . . . Periodic Law. The material universe is unquestionably one of system and order, not chaos, of laws, not chance and hazards" (pages 40-41). In the same book, (*Evidence of God in an Expanding Universe*), Frank Allen writes, "Proteins are the essential constituents of all living cells, and they consist of the five elements, carbon, hydrogen, nitrogen, oxygen, and sulphur, with possible 40,000 atoms in the ponderous molecule. As there are 92 chemical elements (considered stable, W. W.) in Nature, all distributed at random, the chance that these five elements may come together to form the molecule, the quantity of matter that must be continually shaken up, and the length of time necessary to finish the task, can all be calculated" (page 23). The number is 10^{160} to 1, or 10 multiplied by itself 160 times. The length of time needed would be 10^{243} power. He then remarks that it is impossible for all these chances to have built one molecule, and then says (even if such really happened) ". . . proteins as chemicals are without life." So how did it really come to be: life, that is? The evolutionists say they don't know. The odds are nil that conditions are even possible from the make-up of the simplest of matter for life to happen. The only experience we have is life from life. What do you accept by faith: God or evolution? And against what odds?

10. *The supposed evidences are not good evidence!*

The evidence for evolution in this field is based on (1) classification, (2) comparative anatomy, (3) em-

THE CHRISTIAN AND EVOLUTION

bryology, (4) biochemistry, (5) physiology, (6) geographical distribution, (7) vestigial organs, (8) breeding experiments, and (9) mutations.

The first five of these are simply arguments from *similarity*. But whose idea of similarity? How similar or dissimilar are various plants? various animals? Kerkut has said (see point 8) that such arguments only suggest the theory of evolution. So the sum total is still zero $\times 5 = \text{zero}$. It is well known (but little practiced) that arguments from analogy only illustrate, but establish nothing. Such arguments prove nothing in this area. Likenesses may give evidence of a common creator, rather than chance!

Suppose design and purpose, so very evident, are the effects of an all-knowing God. We could see evidence of such in these similarities, could we not?

The idea of classification, as presented in the common "tree of life" assumes the thing to be proved, which is organic evolution. So does the idea of comparative anatomy. The oft presented horse family (and *Life Magazine's* recent chart of man's ancestry) simply but blatantly assumes what it is supposed to prove.

Embryology deals with the likenesses of embryos of different animals (since plants have nothing along this line to offer). But the deductions therefrom are based on the foundation of the first two. Julian Huxley says that an embryo $2/3$ of an inch long possesses different things from his ancestors, such as a tail, and gill clefts. But, the supposed tail happens to be part of the intestine which at this stage (up to about 5th week) extends beyond the legs, and the anal opening is at the end. The 5th to 8th weeks this part begins to form the os coccyx. It then recedes to form the os coccyx. The vertebrae always number 33, and never more, which would be the case if a tail were present. I might add, I don't know

personally of anyone being born with such, do you? If so, were they considered normal?

The argument about *gill clefts* is only to mislead laymen who do not know any better. These embryonic folds never open, and are only there early because they are precursors in mammals of the incus, bones in the ear (stapes) and Meckel's cartilage, the external ear cartilage, hyoid apparatus, a part of the thyroid cartilage, and epiglottis. They also aid the heart in its supplying of blood to the developing brain.

Ernest Haeckel was the first to really promote this lie of embryonic gill clefts, because he was attempting to establish Darwin's theory on the European continent. In his books, *Natürliche Schöpfungs-geschichte* (*Natural History of Creation*) and *Anthropogenie* (The first of these two was published in 1868) he printed a series of woodcuts attempting to show this fact: at certain points in embryonic development, different vertebrate animals and man are alike. So he took the same woodcut and reproduced it three times side by side, and labeled one dog, one monkey, one man. He did the same thing again, changing the woodcut, and labeled one dog, one chicken, and one tortoise. Needless to say, they looked alike! (The interested reader can see these and others reprinted in the *C.R.S.* annual, 1969). The intent to deceive is obvious. Not only so, but when accused of falsifying some diagrams of other scientists for the same purpose, Haeckel said, "To put an end to the unsavoury dispute I begin at once with the contrite confession that a small number (3-6%) of embryo diagrams are really forgeries in Dr. Brass's sense; these, namely, for which the observed material is so incomplete or insufficient as to compel us to fill in and reconstruct the missing links by hypothesis and comparative synthesis . . . I should feel utterly condemned and annihilated by the admission, were it not that hundreds

of the best observers and most reputed biologists lie under the same charge. The great majority of all morphological, anatomical, histological and embryological diagrams are not true to nature, but are more or less doctored, schematized, and reconstructed" (page 63, Enoch).

We also would note here a quote from Hand, page 38, about such reconstructions, from Dr. E. A. Hooten, "The various reconstructions of the Piltdown man by Smith-Woodward, Keith and other experts differ widely from one another. To attempt to restore the soft parts is even a more hazardous undertaking. The lips, the eyes, the ears and the nasal tip leave no clues on the underlying bony parts. You can with equal facility model on a Neanderthal skull the features of a chimpanzee or the lineaments of a philosopher. The alleged restorations of ancient types of men have little if any scientific value and are apt to mislead the public."

We would note that since his remark, the Piltdown man has been exposed as a clever hoax, and is not fact at all though the scientific world in general was misled by him for 40 years. In 1969, the *Argosy* magazine published a big write-up about a newly found missing link, with the article so-titled, and we were off and running again, until some men in California called the Smithsonian Institute and informed them that he was a fabrication of rubber and hair. (The reader should consult the publication called *Doorway Papers* by Arthur Custance for three greatly different reconstructions of Dr. Leakey's "Zinj.")

No embryo helps evolution since it is quite obvious that in many respects the embryos are vastly different, and each of these *always* comes out what it is supposed to be: a dog, cat, etc. At 45 days, there are obvious differences in a dog and human embryo. Nelson, pages 33-36, cites the fact that the house-fly, the human, the fish, the Milkweed butterfly, and others, all have stages

that their ancestry could not possibly have been. The evolutionists call these a "falsification of the ancestral record." He quotes this from Lacy, "Many stages have dropped out, others are unduly prolonged or abbreviated, or appear out of their chronological order. And, besides, some of the structures have arisen from adaptation and are not, therefore, ancestral at all, but are, as it were, recent additions to the text. The interpretation becomes a difficult task, and requires much balance of judgment and profound analysis" (page 34). Nelson adds, "None but an evolutionist, we suppose, is privileged to have the necessary 'balance of judgment.'"

* We will only mention that if such as these were really true, then the attempts to explain the "convergence" of all of these is surely thwarted by a number of animals that have too many ancestors. Blood tests of various mammals show that some humans are more closely related to apes than to fellow humans. We are identical to sheep and other animals in the chemical substance called thyroïdin (from thyroid gland). (What does identity argue?) The milk of asses and humans is more nearly alike than any other. The nervous system of pigs is similar to ours. The plague affects only man and rats. The Australian platypus has a duck-bill covered with fur, has webbed feet, lays eggs, makes a grass-filled nest in a tunnel under water, has four legs and fur, a tail and claws. Which family for this "living fossil?" The Tasmanian animal, known as the "Tasmanian wolf" and called a thylacine, is outwardly like a dog, as also the skeleton. Yet is like the opossums (Marsupial family) and kangaroo in that it bears its young very small and lets them develop in its pouch. Which family is it? Similarity proves nothing except that we can see where the differences leave off and the similarity begins.

THE CHRISTIAN AND EVOLUTION

Vestigial organs is another argument. The set of encyclopedias I have say that man has some 90 of these. We ought to mark these down as items to keep us humble because they betray our ignorance. These things called vestigial organs are organs for which we do not know any use. The glands such as the thyroid gland, the pituitary gland, the thymus, the tonsils: all were once thought to have no use. All are now known to have important functions. Even the appendix is useful as it has to do with blood supply. Some argue that we can remove the appendix and live without it. We could have a lung cut out, or a hand cut off, and get along without them, but that doesn't prove they are not useful. We would readily grant that this is argument by analogy and proves nothing. We don't know that other things are like these. So it is also with the "vestigial" organs: we don't know about the use of some. As time goes on, however, we are finding uses of the once-thought vestigial organs. God may have just planned each of these for a use!

The argument from geographical distribution is an argument from silence generally. You can "prove" all sorts of things by this. Darwin first thought of it when he saw all the life on the Galapagos Islands. The evolutionist has to believe that everything is derived from a common ancestor or else we have had several beginnings. With the numerous stable species, this presents a real problem, since these preclude a change from any preceding species. Too, many species, though widely separated, can interbreed if placed together, which shows that they do not become "new" species by land separation. All in all, this supposed proof has too many gaps for any argument. The interested reader may peruse pages 157-163 of Dewar's book for more information. We would remark that though many languages the world over have been studied, no evidence for evolution has been found. There

are language families, but these do not indicate one common source at all.

We have left only the area of *mutations*. There is much material on this, which will be listed at the end of this paper. We would especially recommend the books by Klotz and Tinkle. The subject is really the issue to be studied, since evolutionists make so much of it, and with the new information on DNA, have generated great interest in this area. For after all, evolution is really a genetic problem. Do things produce after "their kind" or not?

Huxley says: "Mutation . . . is an imperfection in the basic property of living substance, of reproducing itself unaltered; but without it, there could have been no change, and so no improvement of any sort" (page 47). "Mutation . . . provides the raw material of evolution; it is a random affair, and takes place in all directions" (page 36).

So mutations are the key to any change according to Huxley. But it is well to ask: The key to what change? Richard Goldschmidt says, "It is true that nobody thus far has produced a new species or genus, etc., by macromutation. It is equally true that nobody has produced even a species by the selection of micromutations. In the best-known organisms, like *Drosophila*, innumerable mutants are known. If we were able to combine a thousand or more of such mutants in a single individual, this still would have no resemblance whatsoever to any type known as a species in nature" (pages 134, M/W). Enoch writes, "Though 26 generations of *Drosophila* can be observed (and even this rate of mutation can be speeded up by X-ray), so far no accumulation of mutations has been observed" (page 76).

Yet, it seems to me, that if evolution is so scientific, it ought to be demonstratable in the laboratory. We

THE CHRISTIAN AND EVOLUTION

ought to be able to mutate anything to something else, if mutations are the key to change. If we can not do so, then it is unprovable and simply guesswork on the part of those who so claim. This, by the way, is one of the problems and weaknesses on the inexact sciences like Biology and Geology. There is no way to check such guesses as these guesses in the laboratory, (as one can with Physics, for instance).

But we are told that we should not expect such. Dobzhansky says, "These evolutionary happenings are unique, unrepeatable, and irreversible. It is as impossible to turn a land vertebrate into a fish as it is to effect the reverse transformation. The applicability of the experimental method to the study of such unique historical processes is severely restricted before all else by the time intervals involved, which far exceed the lifetime of any experimenter" (page 226, M/W). It sounds to me like these people are saying "We can not prove it or show it, or anything close to it. You are to believe it because we say it."

Mutation is the name for any new variation whose means of production is unknown, or is known by means of an induced change of gene make-up on the chromosomes. That the differing numbers of chromosomes for various species show no evidence of evolution is a remarkable fact. It seems to me that if evolution were true, we should be able to see it in chromosome relationships, since these are the basics of all life. Yet it is not so (see Klotz, 272-274). The simple use of mutations, however, as the sole basis of evolution is highly questionable. They are over 99% lethal, and the remaining 1% is doubtful as to its helpfulness. The reason is that mutations are a change in an orderly process, and they almost invariably cause the thing in which it occurs to be less viable (able to live) than the ones without a mutation.

If such happened outside of the controlled experiment, they would render the things in question less able to survive, and it would likely not survive. Walter Lammerts, C.R.S. annual, 1969, states that in no case do mutations or crossovers provide the recipient with more ability to survive. He also shows, that according to studies, even if 1% of mutations were beneficial, it would take over 900,000 generations to establish a beneficial mutation in a species. You need to consider such things as: what good is an eye or ear if such is not in working order? (It has been estimated that it would take 200 mutations to produce an eye.) How long could fish exist without the ability to breathe under water? Or how long out of water with only gills? The few fossils, supposedly the intermediate links, may have become fossils because they were not the fittest!

Though mutations can be caused in the laboratory, it is not known what causes them outside the laboratory. If a given trait needed at least four factors to produce it (and some take 15), and one of these was recessive, the recessive (as Mendel's law shows) would only appear every 256 times. If there were 10 dominant factors to one recessive, the recessive would only appear once in 16,777,216 times. Would that sudden appearance be considered a mutation? The present breed of cattle being produced without any horns is nothing new. They were known in ancient Egyptian times. Nelson suggests that linkage (crossover) is a possible explanation of the appearance of new traits (pages 187-195). Yet we may be unable to assert that any new trait is not a simple recessive, unless we know absolutely that such a gene was not present in the parents. Humans have varying numbers of genes, according to different calculations, running all the way from 20-120 thousand. With even 20,000, we have a tremendous potential for some trait to be recessive, and

only appear at intervals. Mendel's law would show that with two members mating, with only three genes to consider, if one set of genes were all dominant and the other set recessive, none of the recessives would appear in that cross. Any mating of the resultant offspring would allow the recessive to appear only once out of every 64 offspring. Now, consider the possibilities in 20,000 genes of which we know little. Who can say that, if left unmolested, any new thing would appear? Even in the commonly known fruit fly, the mutation rate for a given gene is only once in 40,000 years. Supposing this to be true, what if the first 999 mutations were harmful? How long would it take to get a new species through mutations? Actually, Julian Huxley shows that even with favorable mutations, the odds against a horse happening are 1 with 5 million zeros behind it. What are the odds against the whole plant and animal world happening? Huxley himself says it is unbelievable. I accept his statement at face value.

Mutations are both harmful and recessive normally. If they become a part of the regular chromosome, they behave as any other gene does. In fact, one reason why mutations are suspect (as able to reproduce new species) is that they reappear. This has been observed in the fruit fly, and the Ancon sheep (a short-legged variety) just to mention two species. Tinkle cites Lammerts as saying that roses mutated might produce a more desirable rose for market purposes, yet every rose thus produced was weaker and less viable than the original Queen Elizabeth variety (page 69).

Remember this also: mutations may change a gene, but a changed gene does not make a new species at all. If one gene is changed in 20,000, what visible effect would it have? The fruit fly, *Drosophila*, has been observed since 1910. More than 1,000 generations have

been observed, innumerable experiments performed, but no accumulation of mutations has been seen. Huxley had to admit that "the direct and complete proof of the utilizations of mutations in evolution under natural conditions has not yet been given" (Enoch, page 78). Ployploidy does not help, since no genes are changed. Ployploidy is a condition which means the chromosome number (diploid number) is more than normal. The number might be triploid, or tetraploid, etc. This condition is probably caused by abnormal cell division of some sort. What causes it though, is as much a mystery as what causes mutations. Polyploidy generally results in larger sizes, but it does not create new species, since the gene make-up remains the same, even though there are more of them. Klotz will note that the fertility rate of polyploids generally is lower, as well as the viability. He quotes H. J. Muller to the effect that *animal* polyploidy is almost impossible, since the chromosome number is upset and sexual mating is thus impossible. This process certainly does not produce new kinds, but just variations, since nothing new is really added. Levan states that each species has an optimum chromosome number, and any increase beyond this number is lethal (Klotz, page 323). Having no proofs, then why must we be told it happens? T. H. Morgan admits that "within the period of human history we do not know of a single instance of the transformation of one species into another . . . It may be claimed that the theory of descent is lacking, therefore, is the most essential feature that it needs to place the theory on a scientific basis. This must be admitted" (Enoch, page 84).

(This is one major problem with the fossils, you see. They prove nothing. Breeding tests can't be applied to them, and this is necessary to determine the relationship of any new form, to another form.)

THE CHRISTIAN AND EVOLUTION

Klotz says that given a population of 100,000,000 organisms with the average generation one day, to expect five simultaneous mutations to happen would require about 270,000,000 years. (To get an eye, you need about 200 simultaneous mutations!)

The stability of the known world is a must to any type of science. Suppose things were not stable. As Dr. Dawson points out, a typhoid germ might turn into a malaria germ from one year to another, if the species, etc., were not constant (Hand, page 43). In other areas of genetics, crossbreeding is a means of producing different types of things, but hybrids are not as stable as needed, in order to keep a new species, and revert back to the original. The thoroughbred is just that: a product of specialized breeding. This does not occur naturally. Many hybrids are sterile and cannot reproduce, such as the male mule. Individual species do not cross naturally, anyway, as any farm boy knows. We will repeat: if the present is the key to the past, organic evolution has not occurred!

There are several areas we did not discuss, or just briefly mentioned. The list of books at the end, or the articles mentioned can give you more information about these areas, such as in genetics about DNA, the Urey-Miller experiment, and polyploidy; in physics, closed and open systems with respect to the Second Law of Thermodynamics; in the area of fossils about the consideration of the different fossil men that are found and the vast fossil beds known, the ice age(s); about the flood and the Bible's claim for God as Creator (over 70 times), and the major differences between man and ape (which are at least over 50 in number), or the arguments against evolution from epistemology such as cause and effect, design, purpose, etc.

We will, however, tell you why Morris makes the statement that "It is not too much to say that the evolu-

tionary philosophy, consistently accepted and applied, squarely contradicts Biblical Christianity in every essential feature" (page 15, *Evolution and the Modern Christian*). It is because, as we have noted before, it does away with all we hold as true and right. Listen to these quotes from Wilder-Smith on page 161: "George Gaylord Simpson is reported as saying that the modern advances in biological sciences had made the religious superstitions, so rampant in North America, untenable, intellectually speaking," and that "it was high time for Americans to throw overboard their naive theism and divine services. The fact that so many still partake in these exercises is, according to Simpson, proof of the sad lack of scientific education and the rampant nature of superstition among Americans." Enoch quotes Huxley as saying that "The doctrine of evolution, if consistently accepted, makes it impossible to believe the Bible" (page 148-149, see also M/W, page 446).

You see, organic evolution accepts a non-miraculous origin of the universe, and its god is chance, its mechanism is natural selection, and its code is survival of the fittest. Frederick Nietzsche's philosophy was the "right of might" and he got it from Darwin. Adolph Hitler applied it, as the Russian Communists do today. The Time-Life book, *Evolution*, states on page 10, ". . . when he (Darwin) started his career, the doctrine of special creation could be doubted only by heretics. When he finished, the fact of evolution could be denied only by an abandonment of reason. He demolished the old theory . . . For it is one thing for man to be told (and want to believe) that he was created in the literal image of God. It is quite another thing for him to be told (and have to accept) that he is, while unique, merely the culmination of a billion years of ever-evolving life, and that he must trace his godhood down a gnarled and twisted family tree through

mammals and amphibians to the lowly fish and thence to some anonymous, if miraculous Adam molecule."

Harlow Shapley in *Science Ponders Religion* writes on page 7, "I point out that modern science has removed the need for appeal to miracles or the supernatural for the origin of molecules, or the origin of life, or the origin of trees, or the origin of man and his curiosity. All these evolve naturally." So he writes, "In the beginning was the Word, it has been piously recorded, and I might venture that the word was hydrogen gas" (page 3).

We would add that, if all scientists were honest, and some had not tried to foist off false evidence on an unsuspecting public to prove the theory, we wouldn't be inclined to scoff at some of their claims. In addition to the now defunct Piltdown man, and Pithecanthropus Erectus (Java), and other hoaxes known to us, Henry Morris mentions in his book, *The Bible and Modern Science*, about (1) the Nebraska Man, whose tooth was found in 1922. This tooth was claimed to be one million years old, and introduced as evidence in the Bryan-Scopes trial in 1925 as such. Mr. Bryan denied that any ancestor lived 1 million years ago, but he was just laughed at. Two years later, the complete skeleton was found and discovered to be an extinct peccary pig. Or, (2) the Colorado Man (also from one tooth) was widely publicised, but the tooth was discovered to be a horse's tooth. Or, (3) a skull of an ape man, exhibited as such, but was later identified as the skull of a pet monkey that had been recently buried. Or, (4) the bone of a bear's hind leg exhibited for a while as an ancient human fibula (page 49ff.). The aforementioned Pithecanthropus Erectus was found in Java in 1891 by Dr. Eugene Debois, and proclaimed as a pre-human relative of man. But, alas, in 1923, the bones of dear old P.E. were identified as genuine bones of humans by Dr. Hrdlicka. So that one is also a hoax, (Rommer,

page 131). Mr. Rimmer also notes that another complete skull was found by Mr. Heberlein, and said to be a companion of the first Pithecanthropus Erectus. However, in that same year of 1926, Dr. Hrdlicka did an investigation of this find, and discovered said skull was actually the knee bone of an extinct elephant! (page 140-141).

We think it will be worth the space to add the following material from G. A. Kerkut's book, *Implications of Evolution*, published in England by Pergamon Press, 1960.

He says in chapter 2:

"Before one can decide that the theory of Evolution is the best explanation of the present-day range of forms of living material one should examine all the implications that such a theory may hold. Too often the theory is applied to, say, the development of the horse and then because it is held to be applicable there it is extended to the rest of the animal kingdom with little or no further evidence.

There are, however, seven basic assumptions that are often not mentioned during discussions of Evolution. Many evolutionists ignore the first six assumptions and only consider the seventh. These are as follows:

(1) The first assumption is that non-living things gave rise to living material i.e., spontaneous generation occurred.

(2) The second assumption is that spontaneous generation occurred only once. The other assumptions all follow from the second one.

(3) The third assumption is that viruses, bacteria, plants and animals are all interrelated.

(4) The fourth assumption is that the Protozoa gave rise to the Metazoa.

(5) The fifth assumption is that the various invertebrate phyla are interrelated.

THE CHRISTIAN AND EVOLUTION

(6) The sixth assumption is that the invertebrates gave rise to the vertebrates.

(7) The seventh assumption is that within the vertebrates the fish gave rise to the amphibia, the amphibia to the reptiles, and the reptiles to the birds and mammals. Sometimes this is expressed in other words, i.e. that the modern amphibia and reptiles had a common ancestral stock, and so on.

The first point that I should like to make is that these seven assumptions by nature are not capable of experimental verification. They assume that a certain series of events has occurred in the past. Thus though it may be possible to mimic some of these events under present-day conditions, this does not mean that these events must therefore have taken place in the past. All that it shows is that it is possible for such a change to take place. Thus to change a present-day reptile into a mammal, though of great interest, would not show the way in which the mammals did arise. Unfortunately we cannot bring about this change; instead we have to depend upon limited circumstantial evidence for our assumptions."

In Kerkut's concluding chapter (10), he writes:

"If we go back to our initial assumptions it will be seen that the evidence is still lacking for the most of them.

(1) The first assumption was that non-living things gave rise to living material. This is still just an assumption.

(2) The second assumption was that biogenesis occurred only once. This again is a matter for belief rather than proof. It is a convenient assumption that life arose only once and that all present-day living things are derived from this unique experience, but because a theory is convenient or simple it does not mean that it is necessarily correct. If the simplest theory was always correct we should still be with the four basic elements—earth, air,

fire, and water! The simplest explanation is not always the right one even in biology.

(3) The third assumption was that Viruses, Bacteria, Protozoa and the higher animals were all interrelated. We have as yet no definite evidence about the way in which the Viruses, Bacteria or Protozoa are interrelated.

(4) The fourth assumption was that the Protozoa gave rise to the Metazoa. Here again nothing definite is known. We can believe that any one of these views is better than any other according to the relative importance that we accord to the various pieces of evidence.

(5) The fifth assumption was that the various invertebrate phyla are interrelated. As has already been described, it is difficult to tell which are the most primitive from amongst the Porifera, Mesozoa, Coelenterate, Ctenophora or Platyhelminthia and it is not possible to decide the precise interrelationship of these groups. The higher invertebrates are equally difficult to relate. The evidence, then, for the affinities of the majority of the invertebrates is tenuous and circumstantial; not the type of evidence that would allow one to form a verdict of definite relationships.

(6) The sixth assumption, that the invertebrates gave rise to the vertebrates has not been discussed in this book. Here again it is a matter of belief which way the evidence happens to point. As Berrill states, 'in a sense this account (of how they arose) is science fiction.'

(7) We are on somewhat stronger ground with the seventh assumption that the fish, amphibia, reptiles, birds and mammals are interrelated. There is the fossil evidence to help us here, though many of the key transitions are not well documented and we have as yet to obtain a satisfactory objective method of dating the fossils.

In effect, much of the evolution of the major groups of animals has to be taken on trust. There is a certain

amount of circumstantial evidence but much of it can be argued either way. Of course one can say that the small observable changes in modern species may be the sort of thing that lead to all the major changes, but what right have we to make such an extrapolation? We may feel that this is the answer to the problem, but is it a satisfactory answer? A blind acceptance of such a view may in fact be the closing of our eyes to as yet undiscovered factors which may remain undiscovered for many years if we believe that the answer has already been found.

What alternative system can we use if we are not to assume that all animals can be arranged in a genealogical manner? The alternative is to indicate that there are many gaps and failures in our present system and that we must realize their existence.

It is in the interpretation and understanding of the factual information and not the factual information itself that the true interest lies.

There is a theory which states that many living animals can be observed over the course of time to undergo changes so that new species are formed. This can be called the 'Special Theory of Evolution' and can be demonstrated in certain cases by experiments. On the other hand there is the theory that all the living forms in the world have arisen from a single source which itself came from an inorganic form. This theory can be called the 'General Theory of Evolution' and the evidence that supports it is not sufficiently strong to allow us to consider it as anything more than a working hypothesis. It is not clear whether the changes that bring about speciation are of the same nature as those that brought about the development of new phyla. The answer will be found by future experimental work and not by dogmatic assertions that the General Theory of Evolution must be cor-

rect because there is nothing else that will satisfactorily take its place."

What do you wish to believe? The evidence for organic evolution is hypothetical. It is really an alternative solution to the problem of origins and a substitute for special creation. Evolution makes man a chance product of time, and effectively eliminates any reason for man to feel obligated to anyone. Might does make right. With God out of the picture, there are no absolutes of any sort. Man is the measure of all things. Everything is relative. Morals mean nothing. Life means nothing. There is no hope, for there is no answer. Life is meaningless. Evil and cruelty have no solution, as Francis Schaeffer points out in *The God Who is There*, "if man has been kicked up out of that which is only impersonal by chance, then those things that make him man—hope of purpose and significance, love, motions of morality and rationality, beauty and verbal communication—are ultimately unfulfillable and are thus meaningless . . . if all of life is meaningless, and ultimately absurd, why bother . . ." (page 89).

So we have a choice. The Bible and special creation give us answers to what we are, from whence we came, and why we are here. We have absolutes and a point of reference. We can hope in a rational understanding of all of life, the universe about us, and ourselves. So it is God or chance. As Schaeffer remarks, "Either there is a personal beginning to everything or one has what the impersonal throws up by chance out of the time sequence" (pages 88).

"As for me and my house, we will serve the Lord!"

NEW TESTAMENT BACKGROUNDS

A Revision of Book I of
New Testament History

by

Dr. William Smith

SECTION I

HISTORY FROM NEHEMIAH TO ANTIOCHUS IV (400-168 B.C.)

1. Four centuries between O.T. and N.T.; Four periods in this time. 2. The high priests: Eliashib, Joiada, Jonathan; the Elephantine letters. 3. The priests: Jaddua; Alexander the Great and Jaddua. 4. Alexander and the Samaritans. 5. Alexander's place in Jewish history. 6. The priests: Onias I; Ptolemy takes Judea; The Ptolemies. 7. The priests: Simon I (the Just). 8. The priests: Eleazar and Manasseh; a. The Greek translation of the O.T.; b. Hellenism and the Jews. 9. The priests: Onias II; Contemporary civil power of Joseph. 10. The priests: Simon II; Judah conquered by Antiochus the Great. 11. The priests: Onias III; Antiochus IV treats the Jews with contempt; Kings of the Greek Kingdom of Syria. 12. The priests: Jason; Hellenistic corruptions. 13. The priests: Menelaus. 14. Wars between Antiochus and Egypt; Subsequent capture and pollution of Jerusalem by Antiochus. 15. Antiochus' campaign to destroy Judaism; Severe religious persecution; The end of Antiochus. 16. Silence of heathen historians on this period of Jewish history; Allusion to it by Tacitus. 17. State of the Jewish nation: held together by religion; increasing exclusiveness; oppression by the nobles. 18. The priests of the Jews after the captivity.

NEW TESTAMENT BACKGROUNDS

WATCH FOR ANSWERS
TO THESE QUESTIONS:

1. How many centuries elapsed between the Old and New Testaments?
2. What are the four periods of history between the O.T. and the N.T.?
3. What Jewish official became the most important person in the state after the time of Nehemiah?
4. What are the Elephantine papyri?
5. Who is the last named high priest in the O.T.? What famous person is this priest supposed to have confronted?
6. What made Alexander the Great angry with the Samaritans? What did he do to punish them?
7. What was the grandiose goal in Alexander's mind as he set out to conquer the world?
8. What language came to be spoken nearly everywhere after the conquests of Alexander?
9. Who were the Ptolemies? What woman was the last of the Ptolemies?
10. How did the Jews regard the priest Simon I?
11. Under what Egyptian king was the Greek Septuagint Old Testament translated? Where?
12. What is *Hellenism*?
13. What kingdom took over Palestine from the Ptolemies of Egypt? Date?
14. By what titles (or nicknames) were the Syrian kings Antiochus III and Antiochus IV called?
15. What were some of the Greek customs which the Syrians and their sympathizers introduced at Jerusalem?
16. What terrible things did Antiochus IV do to the temple in Jerusalem and to its citizens?
17. What edict about worship did Antiochus IV issue throughout his dominion?

INTRODUCTION

18. What was the temple in Jerusalem converted into?
19. What food were some Jews forced to eat?
20. How many brothers of one family were slain before the king?
21. How did Antiochus Epiphanes die?
22. Do heathen historians tell much about the persecutions of the Jews by Antiochus?
23. Had the Jews become purified from their old idolatries by this time?
24. Were the Judean nobles on the side of the Jewish people or of the Syrians? Why?

1. *Four centuries between Old and New Testaments; four periods in this time.*

The interval of four centuries, from the close of the records of the Old Covenant to the events which heralded the birth of Jesus Christ, may be divided into four periods:—the continuance of the Persian dominion, till B.C. 331; the Greek empire in Asia, B.C. 331-167; the independence of Judæa under the Asmonæan princes, B.C. 167-63; and the rule of the house of Herod, commencing in B.C. 40, and extending beyond the Christian era to the destruction of Jerusalem in A.D. 70.

THE FOUR INTER-TESTIMAL PERIODS

1. PERSIAN rule; 539-331 B.C.
2. HELLENISTIC kingdoms 331-167 B.C.
 - a. Egyptian (Ptolemies)
 - b. Syrian
3. INDEPENDENCE (Maccabean) 167-63 B.C.
4. HERODIAN & ROMAN—63 B.C.-A.D. 70

The first two of these periods—a time of about 250 years—form almost a blank in the history of the Jews. They seem to have been content to develop their internal resources and their religious institutions under the mild government of Persia, and the Ptolemies of Egypt.

The last two periods also include the relations of Judæa to Rome. There is little that possesses any great intrinsic interest, except the struggle of the Maccabees for religion and liberty against Antiochus Epiphanes; but the whole period demands our notice as a preparation for understanding the state in which we find the Jews at the opening of the New Testament, their moral and political condition, their views and opinions, their sects and parties.

2. *The high priests: Eliashib, Joiada, Jonathan*

We do not know how far the princes of Judah retained any remnant of their patriarchal authority during the time between the Old and New Testaments; but from the time of Nehemiah, the HIGH-PRIEST became the most important person in the state; and the internal government grew more and more of a hierarchy. In the genealogies of the period, the Levites were recorded as the chief of the fathers. The high-priests from the time of Nehemiah to the end of the empire under Darius Codomannus were Eliashib, Joiada, Jonathan (or Johanan), and Jaddua (listed in Neh. 12:22).

ELIASHIB, the high-priest in the time of Ezra and Nehemiah, was succeeded by his son JOIADA, and he by his son JONATHAN, or JOHANAN (John), down to whose time the heads of the tribe of Levi were entered in the Chronicles of Judah, which seemed therefore to have ended with his priesthood (Neh. 12:10-11, 22.23).

The high-priesthood of Jonathan, which lasted thirty-two years, chiefly in the long reign of Artaxerxes II. Mnemon (405-359 B.C.), was stained by the first of those

THE PERSIAN PERIOD

acts of murderous rivalry, which afterward brought the state to anarchy. His brother, Joshua (Jesus), who was suspected of aiming at the high-priesthood through the favor of Bagoses the Persian satrap, was slain by Jonathan in the temple. The satrap punished the murder by a tax of fifty shekels on every lamb offered in sacrifice, and polluted the temple by his presence.¹ But even in so doing, the Persian taught the Jews the much-needed lesson afterward enforced by a far higher authority: "Am not I purer," he said, "than the dead body of him whom ye have slain in the temple?"

This crime forms the only memorable event in the annals of Judæa, from the government of Nehemiah to the Macedonian conquest, if we except a doubtful account that the country was chastised, and a number of Jews carried captive to Babylon, for their alleged participation in the revolt of the Sidonians under Artaxerxes Ochus (B.C. 351).

During this time (c. 408 B.C.) the Egyptians destroyed a temple built by Jews in Egypt on the island of Yeb (or Elephantine) at the first cataract.² These were probably the Jews who had fled to Egypt in the days of Jeremiah (Jer. 43). They wrote letters (the "Elephantine papyri") to the Persian governors of both Judea and Samaria, requesting authority to rebuild their temple. Apparently permission was never granted, and the Jewish Elephantine colony came to an end about 395 B.C.

THE KINGS OF PERSIA

1. 538-529 B.C.—Cyrus the Great
 2. 529-522—Cambyses
 3. 522-521—Gaumata (Pseudo-Smerdis)
 4. 521-486—Darius I (Hystaspes)
 5. 486-465—Xerxes I (Ahasuerus)
1. About 366 B.C. Josephus, *Ant.* XI, 7, 1.

NEW TESTAMENT BACKGROUNDS

6. 464-424—Artaxerxes I (Longimanus)
7. 424-423—Zerxes II
8. 423-404—Darius II (Nothus)
9. 404-359—Artaxerxes II (Mnemon)
10. 359-338—Artaxerxes III (Ochus)
11. 338-331—Darius III (Codomannus)

3. *The priests: Jaddua; Alexander the Great and Jaddua.*

JADDUA, the son and successor of Jonathan, is the last of the high-priests mentioned in the Old Testament; and his is the latest name in the Old Testament, with the doubtful exception of a few in the genealogies prefixed to the Chronicles. Its insertion in the Book of Nehemiah is a guide to the time when Canon of the Old Testament was finally closed. Eusebius assigns twenty years to the priesthood of Jaddua. He was high-priest both under Darius Codomannus (338-331 B.C.) and after the fall of the Persian empire.

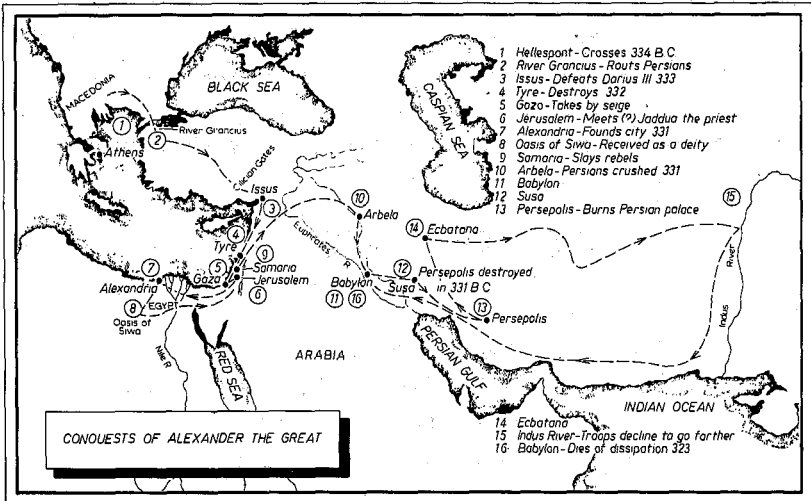

THE GREEK PERIOD

Josephus tells a romantic story of an interview between Jaddua and Alexander the Great. While Alexander was besieging Tyre, he sent to demand the submission of the Jews, who answered that they were the faithful vassals of Darius (B.C. 332.) After taking Gaza, Alexander marched against Jerusalem. Jaddua, by the command of God in a vision, hung the city with garlands, and went forth in solemn procession to meet the conqueror at Sapha (the *watch*), an eminence in full sight of the city and the temple. On seeing the high-priest in his state robes, the priests in their sacred dresses, and the people clothed in white, Alexander fell prostrate in adoration, and rising, embraced the high-priest. To the remonstrances of Parmenio he replied that he worshiped, not the priest, but the NAME engraved upon his frontlet, and that he recognized in him a figure that had appeared to him in a vision in Macedonia, and bidden him to conquer Persia. Entering Jerusalem, he offered sacrifice, and was shown the prophecies of Daniel relating to himself. He granted the Jews, not only in Judæa, but also in Media and Babylonia, the free enjoyment of their own laws, and exemption from the tribute during the Sabbatic year.²

This story raises problems concerning the date of the close of the O.T. canon. Jaddua was the last priest named in the O.T. (Neh. 12:11). If the last O.T. book was written about 420 B.C. (as the ancient Jews believed, and we agree), and Jaddua saw Alexander in 333 B.C., then Jaddua must have been very young when referred to in the O.T., and over ninety years old when he saw Alexander!

The story is discredited by the best critics,³ on account of its internal improbabilities, approaching to contradictions, and the silence of the historians of Alexander. The state-

2. Josephus, *Ant.* XI, 8.

3. Almost certainly Josephus confused the Jaddua of Neh. 12:22 in the time of Darius II, with another Jaddua, high priest in the time of Darius III. See *Biblical Archaeologist*, Dec. 1963, p. 121.

ment of Justin Martyr,⁴ that on Alexander's advance into Syria he was met by many Eastern princes with their diadems, affords some confirmation to the story of the high-priest's coming out to meet him in person. It is certain that Jerusalem and Judæa submitted to the conqueror, and there are traces subsequently of the privileges he is said to have granted to the Jews. Alexander's homage to Jehovah, and his pleasure at being named as the instrument of destiny, are points thoroughly consistent with his character. There is nothing improbable in his having received the submission of Judæa from the high-priest and princes about the time of the siege of Gaza.

At all events, Jerusalem was too important to have been passed over by Alexander himself, as it is by the historians.⁵ He enlisted Jewish soldiers, and removed a large number of Jews to Egypt, to aid in peopling his new city of Alexandria.

4. *Alexander and the Samaritans*

The Samaritans sought to win the favor of Alexander, and claimed the same privileges as the Jews, which Alexander refused to grant. Hence probably arose the rebellion while Alexander was in Egypt, in which they burned alive the Macedonian governor, Andromachus, and which Alexander punished by the destruction of Samaria. Palestine thenceforth remained quiet under Alexander, who died in 323.

In 1962 in the desolate terrain about nine miles north of Jericho, about 200 skeletons, with jewelry, food remains, clothes, coins, much pottery and numerous written documents were found in two caves. The writings indicate that the occupants were Samaritans. After killing Andromachus,

4. *Hist.* xi. 10.

5. This silence must not be overestimated. The neglect of the Maccabean war by the historians of the Greek kingdom of Syria, is an indication already of that somewhat affected contempt which at a later period was expressed by Tacitus (*Hist.* v. 8).

the Samaritans fled to the desolate area when they learned that Alexander was returning in all haste to Samaria. Although the caves are in a very remote area (the Wadi Daliyeh), the Samaritans were discovered (or betrayed), and were mercilessly slaughtered to a man, and their remains thrown back into the caves. After this massacre Alexander established a Macedonian colony at Samaria.⁶

5. *Alexander's place in Jewish history*

The Macedonian conqueror must not, however, be dismissed without some further notice of his real place in Jewish history, and in the sacred history of the world—a place not dependent on any incidental circumstances, such as his visit to Jerusalem.

After the death of Alexander, his empire fell into four parts, each ruled by one of his generals: Ptolemy I in Egypt, Seleucus I in Syria, Cassander in Macedonia, and Lysimachus in Thrace. These four divisions had been symbolized in the prophecies of Daniel by the four-headed leopard and the four horns on the head of the he-goat, which grew up when its first single horn was broken (Daniel 7:6; 8:8).

In the prophetic visions of Daniel the influence of Alexander is necessarily combined with that of his successors. They represented the several phases of his character; and to the Jews nationally the policy of the Syrian kings was of greater importance than the original conquest of Asia. But some traits of "the first mighty king" are given with vigorous distinctness (Dan. 8:21; 11:3). The emblems by which he is typified (a he-goat) and a four-winged leopard) suggest the notions of strength and speed; and the universal extent and marvelous rapidity of his conquests are brought forward as the characteristics of his power,

6. *Biblical Archaeologist*, Dec. 1963, p. 110ff.

which was directed by the strongest personal impetuosity (Dan. 8:5, 6). He "ruled with great dominion, and did according to his will; and there was none that could deliver . . . out of his hand" (Dan. 8:7; 11:3).

The tradition of his visit to Jerusalem, whether true or false to fact, presents an aspect of Alexander's character which has been frequently lost sight of by his recent biographers. He was not simply a Greek, nor must he be judged by a Greek standard. The Orientalism, which was a scandal to his followers, was a necessary deduction from his principles, and not the result of caprice or vanity. He approached the idea of a universal monarchy from the side of Greece, but his final object was to establish something higher than the paramount supremacy of one people. His purpose was to combine and equalize—not to annihilate: to wed the East to West in a just union—not to enslave Asia to Greece. The time, indeed, was not yet come when this was possible; but if he could not accomplish the great issue, he prepared the way for its accomplishment.

The first and most direct consequence of the policy of Alexander was the weakening of nationalities, the first condition necessary for the dissolution of the old religions. The swift course of his victories, the constant incorporation of foreign elements in his armies, the fierce wars and changing fortunes of his successors, broke down the barriers by which kingdom had been separated from kingdom, and opened the road for larger conceptions of life and faith than had hitherto been possible. The contact of the East and West brought out into practical forms thoughts and feelings which had been confined to the schools. Paganism was deprived of life as soon as it was transplanted beyond the narrow limits in which it took its shape. The spread of commerce followed the progress of arms; and the Greek language and literature vindicated their claim to be considered the most perfect expression of human thought by

becoming practically universal. Greek came to be spoken nearly everywhere.

The Jews were at once most exposed to the powerful influences thus brought to bear upon the East, and most able to support them. In the arrangement of the Greek conquests, which followed the battle of Issus, 331 B.C., Judæa was made the frontier land of the rival empires of Syria and Egypt; and though it was necessarily subjected to the constant vicissitudes of war, it was able to make advantageous terms with the state to which it owed allegiance, from the important advantages which it offered for attack or defense. Internally also the people were prepared to withstand the effects of the revolution which the Greek dominion effected. The constitution of Ezra had obtained its full development. A powerful hierarchy had succeeded in substituting the idea of a church for that of a state, and the Jew was now able to wander over the world and yet remain faithful to the God of his fathers. The same constitutional change had strengthened the intellectual and religious position of the people. A rigid fence of ritualism protected the course of common life from the license of Greek manners; and the great doctrine of the unity of God, which was now seen to be a divine centre of their system, counteracted the attractions of a philosophic pantheism. Through a long course of discipline, in which they had been left unguided by prophetic teaching, the Jews had realized the nature of their mission to the world, and were waiting for the means of fulfilling it. The conquest of Alexander furnished them with the occasion and the power. But at the same time the example of Greece fostered personal as well as popular independence. Judaism was speedily divided into sects, analogous to the typical forms of Greek philosophy. But even the rude analysis of the old faith was productive of good. The freedom of Greece was no less instrumental in forming the Jews for

their final work than the contemplative spirit, of Persia, or the civil organization of Rome; for if the career of Alexander was rapid, its effects were lasting. The city which he chose to bear his name perpetuated in after ages the office which he providentially discharged for Judaism and mankind; and the historian of Christianity must confirm the judgment of Arrian, that Alexander, "who was like no other man, could not have been given to the world without the special design of Providence." And Alexander himself appreciated this design better than his great teacher; for it is said⁷ that when Aristotle urged him to treat the Greeks as freemen and the Orientals as slaves, he found the true answer to this counsel in the recognition of his divine mission to unite and reconcile the world.

THE PTOLEMIES

The Ptolemies were a dynasty of Macedonian kings who ruled in Egypt 323-30 B.C.

PTOLEMY I (Soter)—323-285 B.C. Son of Lagus. Invaded Palestine four times (318, 312, 302, 301 B.C.). Palestine was ruled by the Ptolemies till 198 B.C.

PTOLEMY II (Philadelphus)—285-246. A period of material and literary splendor. LXX produced.

PTOLEMY III (Euergetes I)—246-221. Conquered the Syrian Seleucid kingdom. Apex of the Ptolemaic age.

PTOLEMY IV (Philopator) — 221-204. Immoral. Threatened by Antiochus III.

PTOLEMY V (Epiphanes)—204-181. Palestine lost to the Seleucids. He is the king praised by the Rosetta Stone.

PTOLEMY VI (Philometor) — 181-145. Antiochus IV invaded Egypt in 170 and captured Philometor, although he was later released. He was perhaps the best of the Ptolemies.

7. Plutarch, *de Alex.*, Or. 1, 6.

THE PTOLEMIES

PTOLEMY VIII (Euergetes II), brother of Philometor, was made king by the Alexandrians in 170 B.C. He was in constant rivalry with Philometor, who captured him in 154, when Euergetes invaded Cyprus. Euergetes was immoral, cruel, fat, foul, and tyrannical.

PTOLEMY VII (Philopator Neos), son of Philometor, was proclaimed king in 145, but Euergetes II took over the throne and ruled to 116.

PTOLEMY IX (Soter II) reigned in Egypt 116-108, with his brother **PTOLEMY X** (Alexander I) reigning as a rival, from Cyprus. From 108 to 89 the situation was reversed with Alexander in Egypt and Soter in Cyprus. Then Soter returned to rule in Egypt, 88-80 B.C.

PTOLEMY XI (Alexander II). Son of Alexander I. Ruled 20 days in 80 B.C., and was killed by the Alexandrians.

PTOLEMY XII (Philopator Philadelphius Neos Dionysus)—80:51. Called Auletes, meaning "flute-player." Son of Soter II. Exiled by popular hatred between 58-55, but restored himself by bribery and murder.

PTOLEMY XIII (Philopator)—51-47. Son of Philopator XII. Married his sister **CLEOPATRA VII**, age 17. In this time Egyptian history coalesces with Roman history. Ptolemy XIII was killed in the Alexandrian wars of Julius Caesar, 48-47.

PTOLEMY XIV (Philopator)—47-44. Brother of Ptolemy XIII. Associated as ruler with Cleopatra. Died probably by Cleopatra's contriving.

PTOLEMY XV (Philopator Philometor Caesar)—44-30. Son of Cleopatra (by Julius Caesar, she claimed). He was called "Little Caesar." In 30 Cleopatra died (suicide), and Little Caesar was murdered. Egypt was made a Roman province by Octavian.

6. *The priests: Onias I (330-309 B.C.);
Ptolemy takes Judea.*

Jaddua was succeeded, some time before the death of Alexander, by his son ONIAS I., who was high-priest from about B.C. 330 to B.C. 309, or, according to Eusebius, B.C. 300. In the division of the empire of Alexander, Palestine was treated, as it had always been considered by the Greeks, as a part of Syria; and so it fell to the lot of Laomedon, who was dispossessed, in 321-320 B.C., by Ptolemy, the son of Lagus, the powerful satrap of Egypt. Ptolemy took Jerusalem by assaulting it on the Sabbath, when the Jews would offer no resistance.⁸ He carried off a large number of Jewish and Samaritan captives to Alexandria, where he gave them the full citizenship; and many others migrated to Egypt of their own accord. In the wars that followed, Palestine was alternately the prize of victory to Antigonus and Ptolemy, till the peace which followed the battle of Ipsus assigned it to Ptolemy, with Phœnicia and Cœlesyria, as a dependency of the kingdom of Egypt, 301 B.C. It was subject to the first five Ptolemies for about a century 301-198 B.C. The sufferings inflicted upon Palestine and Phœnicia by the wars of the *Diadochi* (as the successors of Alexander were called in Greek) were almost confined to the maritime regions, where the strong cities, such as Gaza, Joppa, and Tyre, were the chief objects of contention. As in the old wars between Assyria and Egypt, Jerusalem lay out of the direct track of the combatants.

7. *The priests: Simon I (the Just) (300-292 B.C.).*

Just after the battle of Ipsus, the high-priesthood passed to SIMON I, THE JUST, son of Onias I. (about 300-292 B.C.). Jewish tradition makes him the greatest of this later line of priests. In the magnificent eulogy of Jesus

8. Josephus, *Contra Apion* I, 22; *Ant.* XII, 1

the son of Sirach, Simon is said to have fortified the temple, doubling the height of the wall, and to have maintained the divine service in the highest splendor. "When he put on the robe of honor, and was clothed with the perfection of glory, when he went up to the holy altar, he made the garment of holiness honorable."⁹ Other traditions make Simon the last survivor of the *Great Synagogue* of 120, who returned with Ezra from the Babylonish Captivity, and ascribe to him the final completion of their great work, the Canon of the Old Testament. They were succeeded by the *New Synagogue*, whose office was to interpret the Scriptures thus completed. Its founder was Antigonus Socho, the first writer of the *Mishna*. He is said to have received from Simon the Just the body of oral tradition handed down from Moses. To him also is ascribed the doctrine that God ought to be served disinterestedly, and not for the sake of reward; which was perverted by one of his disciples into the denial of all future rewards and punishments. That disciple was Zadok (or Sadduc), founder of the *Sadducees*. But the tradition rests on insufficient evidence, and the etymology is extremely doubtful.

The fondness with which Jewish tradition regarded the priesthood of Simon, as the best period of the restored theocracy, is indicated by the miraculous signs which were said to have heralded impending disaster at its close. "The sacrifices, which were always favorably accepted during his life, at his death became uncertain or unfavorable. The scape-goat, which used to be thrown from a rock, and to be dashed immediately to pieces, escaped (a fearful omen) into the desert. The great west light of the golden chandelier no longer burned with a steady flame—sometimes it was extinguished. The sacrificial fire languished; the sacrificial bread failed, so as not to suffice, as formerly, for the whole priesthood." (Milman.)

9. *Ecclesiasticus* 50.

8. *The priests: Eleazar (292-251 B.C.) and Manasseh (251-240 B.C.).*

Simon the Just was succeeded by his brother ELEAZAR, his son Onias being under age (292-251 B.C.). His long rule seems to have been profoundly tranquil, under the mild governments of Ptolemy I. Soter (the son of Lagus), and PTOLEMY II PHILADELPHUS, who succeeded his father in 285 B.C. and reigned till 246 B.C. Manasseh, the brother of Eleazar, was associated with him in the priesthood, and held it after him till 240 B.C.

a. *The Greek translation of the Old Testament (Septuagint).*

To the literary tastes of the Egyptian King Ptolemy II Philadelphus, and to the co-operation of Eleazar, the tradition preserved by Aristeas ascribes the Greek Version of the Jewish Scriptures, which is called the SEPTUAGINT, from its seventy or seventy-two translators.¹⁰ Much as there is erroneous and even fabulous in the tradition, there can be no doubt that that first portion of the translation was executed at this time by learned Jews and Alexandria.

b. *Hellenism and the Jews.*

The production of the Septuagint marks an important epoch in Jewish history; not merely the embodiment of the sacred writings in a form in which they might act upon the Gentile world, but, conversely, the growing strength of those influences which are denoted by the general name of *Hellenism* (derived from *Hellas*, the Greek name of Greece). The conquests of Alexander, and the kingdoms founded by his successors in Asia Minor, Syria, and Egypt, had led to a most powerful infusion of Greek population, manners,

10. Josephus, *Ant.* XII, 2

literature, art, and religion throughout Western Asia, and Greek was rapidly becoming a universal language in that region. The Jews of Egypt, whose numbers from the successive migrations we have noticed, were now very large, had doubtless become so far *hellenized*, that a Greek version of the Scriptures may have been as much needed for their use as for Ptolemy's curiosity. Thus it happened, in the Divine Providence, that the growth of Oriental Hellenism prepared the way for the spread of Christianity, not only by imbuing half the world with a common civilization and a common language, but by providing in that language the sacred standard of divine truth by which the Messiah's claims were to be established, and the words of which he was to fulfill. But meanwhile that same Hellenism brought upon the Jews a new series of national trials. The Jews of Palestine appear to have been thus far singularly free from hellenizing tendencies; but the time soon came when their exemption was no longer preserved.

9. *The priests: Onias II (240-226 B.C.);
Contemporary civil power of Joseph.*

After the successive rules of his uncles Eleazar and Manasseh, ONIAS II, at length entered on the high-priesthood in 240 B.C. He endangered the long friendship with Egypt by neglecting to pay the annual tribute of twenty talents to PTOLEMY III. EUERGETES, who had succeeded his father in 246 B.C. The high-priest's unreasonable avarice led to the first interruption of that kindly policy which the first three Ptolemies had uniformly preserved toward Judæa, and he was too indolent to obey the summons to answer for his conduct, under the threat of invasion. An open rupture was only averted by the policy of the high-priest's nephew, JOSEPH, the son of Tobias, who forms a great contrast to his uncle. Joseph borrowed the money for his journey from some rich Samaritans, and traveled to Alex-

andria in the company of certain Phœnician merchants, from whom he learned the sum they intended to bid for the farming of the tribute to Palestine, Phœnicia, and Cœlesyria. Having succeeded in appeasing Ptolemy by representing the weakness of Onias, Joseph offered to double the sum of 8000 talents, at which the merchants proposed to farm the revenues; and, when asked for his sureties, named the king and queen themselves, secure in the progress he had made in the royal favor.¹¹ He obtained the contract. By a few severe examples, as at Ascalon and Scythopolis, he succeeded in discharging his office, and in establishing a civil authority side by side with that of the high-priest. His rule lasted for twenty-two years, and the power which he had set up in the state became a source of evils as great as the danger from which he had delivered it.

10. *The priests: Simon II (226-198 B.C.); Judah conquered by Antiochus the Great (the Syrian).*

Onias II. died in 226 B.C., and was succeeded by his son SIMON II.; and four years later the crown of Egypt passed to PTOLEMY IV. PHILOPATOR (222-205 B.C.). Meanwhile the rival kingdom of Seleucidæ, in Syria, had reached the climax of its power, and the throne had just been ascended by the most ambitious of its kings, ANTIQCHUS III. THE GREAT (223-187 B.C.). He made war on Ptolemy for the provinces of Phœnicia, Cœlesyria, and Palestine; but was defeated at the battle of Raphia, near Gaza, 217 B.C. After this victory, Ptolemy went to Jerusalem; and, not content with offering sacrifices, he entered the Holy of Holies, whence he is said to have been driven out by a supernatural terror. He gave vent to his resentment by a cruel persecution of the Jews at Alexandria, the first example of such a

11. It is recorded, as a proof of the good-will of Ptolemy Euergetes to the Jews, that he offered sacrifices at Jerusalem.

THE PTOLEMIES

measure for nearly 200 years. Its consequence was the alienation of the Jews both of Palestine and Egypt.

The death of Ptolemy Philopator, when his son PTOLEMY V. EPIPHANES¹² (205-181 B.C.) was only five years old, gave a new opening to the ambition of Antiochus the Great. That king, who had been occupied for the last twelve years in subduing a revolt in Asia Minor and attempting in vain to recover the provinces beyond the Tigris from the Parthians and Bactrians, formed a league with PHILIP V. OF MACEDON for the partition of Ptolemy's dominions. After a fierce contest, in which Judea suffered severely, Antiochus became master of Coelesyria¹³ and Palestine (198 B.C.). The Jews, who had again been ill-treated by Scopas, the general of Ptolemy, welcomed Antiochus as a deliverer. He granted them an annual sum for the sacrifices, and forbade foreigners to enter the temple.

11. *The priests: Onias III (198-171 B.C.); Antiochus IV treats the Jews with contempt.*

In the same year, Simon II. was succeeded in the high-priesthood by his son ONIAS III. (198-171 B.C.). The conquered provinces were restored to Ptolemy Epiphanes as the dowry of his bride, Cleopatra, the daughter of Antiochus; but the Syrian king did not give up their possession; and he took them back altogether by the treaty with Rome in 188 B.C. He lost his life in the following year. It is under his son and successor, SELEUCUS IV. PHILOPATOR (187-175 B.C.), that the writer of the *Second Book of Maccabees* places the attempt of Heliodorus to seize the treasures of the temple, and his miraculous repulse (II Macc. 3).

12. This is the king whose coronation decree, inscribed on the "Rosetta Stone," has afforded the foundation for the art of deciphering the Egyptian hieroglyphics.

13. *Coelesyria* is the broad valley between the Lebanon and Anti-Lebanon mountains. The name is loosely applied to all of southern Syria.

Heliodorus was chancellor of Seleucus, and was sent to Jerusalem to confiscate treasures which one Simon, a Jewish temple guard, had told him were there. As Heliodorus demanded the money in Jerusalem, he saw "a horse with a terrible rider upon him . . . and he rushed fiercely and some at Heliodorus." Also two other "young men" (angels?) appeared and scourged him unceasingly, and only spared his life because of the prayers of Onias.

The story, of which Josephus knows nothing, illustrates the tendency of apocryphal writers to adorn their books with feeble imitations of the miracles recorded in the Scriptures. All we know for certain is, that Onias could scarcely maintain his favor with Seleucus against the machinations of Simon, who is said to have instigated the sacrilege; and the bloody feud thus commenced between the partisans of the high-priest and those of Simon hastened the calamities that followed the transfer of the supremacy of Syria.¹⁴

The accession of ANTIOCHUS IV. EPIPHANES¹⁵ (175-164 B.C.) secured the triumph of the Syrian party in Judæa. This prince, whose conduct, as well as his end, gained him the nickname of *Epimanes* (the madman) had been sent by his father, Antiochus the Great, as a hostage to Rome. He returned with a contempt for his subjects added to that love of oriental luxury which the kings of Syria had now acquired; but his vices might have been chiefly dangerous to himself had not his Roman education inflamed the ambition which he inherited from his father.

12. *The priests: Jason (175-172 B.C.); Hellenistic corruptions.*

Antiochus IV Epiphanes found the Jewish high-priest Onias III at Antioch, whither Onias had gone to clear him-

14. Simon is called a Benjamite. There are difficulties concerning the family to which he belonged. Could Simon have been the "Man of the lie" mentioned in the Dead Sea scrolls? See Sec. VI, 4, b.

15. *Epiphanes* means "the radiant one."

THE PTOLEMIES

KINGS OF THE GREEK KINGDOM OF SYRIA.

Kings.	Length of Reign.	Date of Accession.
1. Seleucus I. Nicator	32 years	Oct. 312.
2. Antiochus I. Soter	19 "	Jan. 280.
3. Antiochus II. Theos	15 "	Jan. 261.
4. Seleucus II. Callinicus	20 "	Jan. 246.
5. Seleucus III. Ceraunus	3 "	Aug. 226.
6. Antiochus III. the Great	36 "	Aug. 223.
7. Seleucus IV. Philopator	12 "	Oct. 187.
8. Antiochus IV. Epiphanes	11 "	Aug. 175.
9. Antiochus V. Eupator	2 "	Dec. 164.
10. Demetrius I. Soter	12 "	Nov. 162.
11. Alexander Balas	5 "	Aug. 150.
Demetrius II. Nicator (1st reign)		
12. Antiochus VI. Theos Tryphon	9 "	Nov. 146.
13. Antiochus VII. Sidetes	9 "	Feb. 137.
Demetrius II. Nicator (2d reign)		
Alexander Zebina	3 "	Feb. 128.
14. Seleucus V.	3 "	Feb. 125.
15. Antiochus VIII. Grypus	13 "	Aug. 125.
16. Antiochus IX. Cyzenicus	18 "	" 113.
17. Seleucus VI.	18 "	" "
18. Antiochus X. Eusebes Philippus	12 "	" 95.
19. Tigranes	14 "	" 83.
20. Demetrius III. Eucaerus	14 "	" "
21. Antiochus XI. Epiphanes	14 "	" "
22. Antiochus XII. Dionysus	14 "	" "
23. Antiochus Asiaticus	4 "	69.

self from the accusations of Simon, which were backed by the hostility of Apollonius, the governor of Coele Syria. The Greek party was represented, not only by Simon, but by the high-priest's own brother, Joshua (Jesus), who went so far as to adopt the Greek name of Jason. By an enormous bribe in money and promises of annual tribute, Jason (175-172 B.C.) obtained the high-priesthood, while Onias III. was deposed and detained at Antioch. (II Macc. 4:1-9). For the first time, Greek customs were openly introduced into Judæa, with a success which shows to what an extent the Jews had already become hellenized in spirit. Not content with surrendering the privileges of free worship obtained from former kings, and neglecting the services of the temple, Jason built a gymnasium where the Jewish youth practiced the Greek athletic exercises, some of them

even obliterating the mark of circumcision (I Macc. 1:10-15; II Macc. 4:10-17). Jason also sent representatives to the quinquennial games of the Tyrian Hercules with large presents, which even his envoys scrupled to apply to the heathen sacrifices, but bestowed them for building ships. (II Macc. 4:18-20).

13. *The priests: Menelaus (172-168 B.C.).*

In three years, however, Jason was in his turn undermined by MENELAUS (172-168 B.C.),¹⁶ whom he had sent to Antioch with the tribute, and who obtained the high-priesthood by flattering the king's vanity and offering a higher bribe. He arrived at Jerusalem, "having the fury of a cruel tyrant and the rage of a wild beast," while Jason fled to the Ammonites (II Macc. 4:23-26). Unable to raise the money he had promised, Menelaus was summoned to Antioch. He sold some of the vessels of the temple to the Tyrians in order to bribe Andronicus, who governed Antioch during the king's absence in Cilicia. The deposed high-priest, Onias, who was still at Antioch, charged Menelaus with the sacrilege, and fled for sanctuary to the sacred grove of Daphne. At the instigation of Menelaus, Andronicus enticed Onias from the sanctuary and put him to death (171 B.C.). Antiochus, who returned about this time, was moved to pity by the blameless character of Onias; and, perceiving doubtless the treasonable schemes of Andronicus, he put the murderer to death. Meanwhile a great tumult had broken out at Jerusalem in consequence of the sacrileges committed by Lysimachus, the brother and deputy of Menelaus. Lysimachus was killed, and Menelaus was accused before Antiochus, when he reached Tyre on

16. According to Josephus, this was a younger brother of Onias III and Jason, who had changed his own name, Onias, to Menelaus (*Ant.* xii. 5, 1); but in 2 Macc. iv. 28, he is made the brother of Simon the Benjamite. If so, his usurpation carried the high-priesthood out of the house of Aaron.

his way to attack Egypt; but Menelaus escaped through bribery, and his accusers were punished for the insurrection (II Macc. 4:28-50).

14. *Wars between Antiochus and Egypt; subsequent capture and pollution of Jerusalem by Antiochus.*

We must here glance at the relations of Syria toward Egypt. PTOLEMY VI. PHILOMETOR was an infant when he succeeded his father in B.C. 181; but the government was ably conducted by his mother Cleopatra, the sister of Antiochus Epiphanes. Her death (173 B.C.) led to the war with Syria, and Antiochus successfully conducted four campaigns against Egypt (171-168 B.C.), from which he only retired on the haughty mandate of the Roman ambassador, M. Popillius Lænas. During the second of these campaigns (170 B.C.), a report was spread of the king's death. Jason attacked Jerusalem at the head of 1000 men and drove Menelaus into the citadel; but, after great cruelties against the citizens, he was compelled to fly to the land of Ammon. Thence he fled to Egypt, and afterward to Sparta, where he sought protection on some claim of kindred, and there he "perished in a strange land" (II Macc. 5:5-10). Meanwhile his attempt had the most extraordinary consequences in the history of the Jews.

Antiochus was led to believe that Judæa had revolted, an idea no doubt encouraged by Menelaus, in order to get rid of his own enemies. The king returned from Egypt in a state of fury; took Jerusalem by storm, slaying young and old, women and maidens. Forty thousand fell in the conflict, and as many were sold into slavery. Guided by Menelaus, he entered the temple, profaned the altar by the sacrifice of a swine, and having caused part of its flesh to be boiled, he sprinkled the broth over the whole sanctuary, and polluted the Holy of Holies with filth. He

carried off the sacred vessels and other treasures to the amount of 1800 talents, and returned to Antioch, leaving a savage Phrygian named Philip as his governor at Jerusalem, and Andronicus at Gerizim, where the Samaritan temple seems to have been profaned in like manner (I Macc. 1:20-28; 2:11-23). Menelaus, who is stigmatized as the worst of all the three, is not again named in the *Books of Maccabees*. His subsequent death under Antiochus Eupator was regarded as a judgment for his crimes (163 B.C.) (Josephus, Ant. XII, 9, 7).

15. *Antiochus' campaign to destroy Judaism; severe religious persecutions; the end of Antiochus.*

Two years later (168 B.C.) Antiochus vented upon Judæa the exasperation of his dismissal from Egypt. Policy too, as well as passion, may have urged him to destroy a province now thoroughly disaffected and likely soon to fall into the power of Egypt. Apollonius, the old enemy of the Jews, was sent to Jerusalem at the head of 22,000 men, with orders to slay all the male adults, and to seize the women and children. Pretending that his mission was friendly, he waited till the Sabbath and then fell upon the unresisting people. A frightful massacre took place: the city was pillaged and set on fire; its fortifications were dismantled; and a tower was erected on Mount Zion, overlooking both the temple and the city, from which the garrison sallied forth upon all who dared to resort to the deserted sanctuary. Then followed one of the severest persecutions recorded in the history of religion (I Macc. 1:29ff.; II Macc. 5:24-26). Antiochus issued an edict for uniformity of worship throughout his dominions, and committed its execution in Samaria and Judæa to an old man named Athenæus, one of those fanatics who have been produced by heathenism, as well as by religions that

claim a more earnest faith (II Macc. 6:1). A strong element of such fanaticism may be traced in the character of Antiochus himself. While his quick and versatile Greek temperament, trained in Roman ideas of power, and corrupted by oriental luxury, led him to indulge in all the vices and feasts for which despotism supplied the means—at one time rioting through the streets of Antioch with his boon companions, at another going through a mock canvass for the Roman magistrates, and pretending to hold them—he was all the while a munificent and bigoted supporter of the Greek worship. “The admirers,” says Dean Milman, “of the mild genius of the Grecian religion, and those who suppose religious persecution unknown in the world before the era of Christianity, would do well to consider the wanton and barbarous attempt of Antiochus to exterminate the religion of the Jews and substitute that of the Greeks.”

The Samaritans submitted without resistance, and their temple on Mount Gerizim was dedicated to Zeus Xenius. At Jerusalem Athenæus began his work by converting the sanctuary into a temple of Zeus Olympius. Its courts were polluted by the most licentious orgies; the altar was loaded with abominable offerings; and the old idolatry of Baal was reestablished in the obscene form in which it had been carried to Greece—the phallic revels of Dionysus. The copies of the Book of the Law were either destroyed, or profaned by heathen and doubtless obscene pictures (I Macc. 3:48).

The practice of Jewish rites, and the refusal to sacrifice to the Greek gods, were alike punished with death. Two women who had circumcised their children, were led round the city with the babes hanging at their breasts, and then cast headlong from the wall. A company of worshipers were burned by Philip in a cave to which they had fled to keep the Sabbath. The favorite test of con-

formity was the compulsion to eat swine's flesh; and two particular cases of heroic resistance make this one of the brightest pages in Jewish and Christian martyrology. A chief scribe, named ELEAZAR, a man of noble person and ninety years of age, when a piece of swine's flesh was thrust into his mouth, spat it out, and willingly offered his body to the torments. When some of the officers, for old acquaintance sake, besought him to provide some meat, and eat it as if it were the unclean food, he made a reply which contains the whole justification of the martyr's constancy to death: "It becometh not our age in anywise to dissemble, whereby many young persons might think that Eleazar, being fourscore years old and ten, were now gone to a strange religion, and so through mine hypocrisy, and desire to live a little time, should be deceived by me, and I get a stain to my old age, and make it abominable. For though for the present time I should be delivered from the punishment of men, yet I should not escape the hand of the Almighty, neither alive, nor dead." He concluded by declaring his resolve, "to leave a notable example to such as be young to die willingly and courageously for the honorable and holy laws." His tempters, incensed at his obstinacy, grew doubly cruel, and, as he was expiring beneath their blows, he cried—"It is manifest unto Jehovah, that hath the holy knowledge, that whereas I might have been delivered from death, I endure sore pains in body by being beaten; but in soul am well content to suffer these things, because I fear Him" (II Macc. 6). Thus was he "tortured,"¹⁷ not accepting deliverance, that he might obtain a better resurrection;" and he is included, with the other martyrs of the age, in the "cloud of martyrs," "of

17. Heb. 11:35-36. The very word chosen by the apostle "tortured" expresses the kind of torture inflicted on Eleazar and other martyrs of this time. It refers to torture on a wheel-shaped instrument, across which people were stretched and then beaten with clubs or thongs. The whole passage clearly shows that the writer had them in his mind, though their history is not recorded in the canonical Scriptures.

whom the world was not worthy," "who obtained a good report through faith."

"Others had trial of mockings and scourgings." Such was the fate of the seven brethren who, with their mother, were brought into the king's own presence, and, having refused to eat swine's flesh, were put to death with insults and torments, of which the horrid details may be read in the original text. From the eldest to the youngest, they displayed not only constancy but triumph; and the mother, after encouraging each in his turn, herself suffered last (II Macc. 7). The atrocities committed at Jerusalem were rivaled in the country. But at this very crisis, when the worship and the people of Jehovah seemed doomed to extinction, a new light arose for both; and the result showed how needful was the baptism of fire to purify the people from the corruptions of Hellenism.

Meanwhile the persecutor himself became a signal example of the retribution which awaits despotic power and unbridled passion; and, before relating the resurrection of Judæa under the Maccabees, we may anticipate the short period of four years to notice the fate of Antiochus Epiphanes. He was in the eastern provinces when he heard of the revolt of Judæa and the defeat of his general Lysias. Hastening back to avenge the disgrace, he attacked a temple at Elymais, the very place where his father had lost his life in a similar attempt. The mortification of being repulsed seems to have brought to a climax the madness which despotism usually engenders; and he died in a raving frenzy at Tabæ in Persia, 164 B.C. His end was regarded, by Greeks as well as Jews, as a judgment for his sacrilegious crimes; and he has left to history a name as odious as that of Nero, with whose character he had many points in common.

16. *Silence of heathen historians on this period of Jewish history; allusion to it by Tacitus.*

It is very remarkable that this great persecution, and the subsequent history of the glorious regeneration of Judæa under the Maccabees, should have been passed over by the Greek and Roman historians. From Polybius we might have expected a just appreciation of its importance, and an impartial summary of its facts; but of this portion of his work only a few fragments remain, and the silence of Livy, who closely follows his history of Syria, seems to imply that of his great authority. Appian's meagre summary of Syrian history takes no notice of the Jews. Diodorus gives a very brief account of them, repeating the current prejudices, not as his own belief, but as arguments used by the counselors of Antiochus to urge the extirpation of the Jews. The contemptuous summary given by Tacitus is even more significant than the silence of the rest and shows how far prejudice can lead even the most careful writers from the truth. He speaks as follows:—"During the dominion of the Assyrians, the Medes, and the Persians, the Jews were the most abject of their dependent subjects. After the Macedonians obtained the supremacy of the East, King Antiochus endeavored to do away with their superstition and introduce Greek habits, but was hindered by a Parthian war from reforming a most repulsive people."¹⁸

The spirit of this passage may explain the indifference of other authors. The uncompromising devotion of the Jews to their religion and their national traditions, and their claim to be worshipers of the only true God, excited among the heathen, and especially those who laid claim to philosophy, the same affected contempt and unaffected resentment which led Gibbon to sneer at Palestine as a country no larger nor more favored by nature than Wales.

18. *Teterriman gentem*, Tac. Hist. v. 8.

THE PTOLEMIES

The keen inquiries of Herodotus, who visited Egypt and Tyre at the very time when Ezra and Nehemiah were regulating the restored state, produced nothing but the notice of Necho's victory over Josiah and capture of Cadytis (probably Gaza), the mistake "that the Syrians of Palestine" learned circumcision from the Egyptians, and the mention of them as serving with the Phœnicians in the fleet of Xerxes.¹⁹

The silence of the historians of Alexander and his successors about the Jewish people is the more remarkable, as they have to mention Judæa as the scene of war; it is matched by the Romans even when they come into contact with Syria and Egypt; nor is it even broken when (if we may believe the historian of the Maccabees) Rome formed an alliance with Judas Maccabæus.

A century later when Pompey penetrated into the temple, the sacred city suggests even to Cicero nothing better than a nickname for his distrusted leader; nor does Tacitus notice the very advent of Christ with half the interest he shows in the relations of the Herodian princes to the Cæsars. Surely we can not but see in all this a divine purpose, that the outer, like the inner life, of the chosen people, should lie hidden from the world at large, and pursue a course apart from the ordinary current of warlike and political conflict, till from their bosom should emerge the band of lowly and unworldly men, who were to proclaim a "kingdom not of this world."

17. State of the Jewish nation: held together by religion; increasing exclusiveness; oppression by nobles.

In preparation for that event, the Jewish people had a history of its own, for which we could wish to possess

19. Herodotus ii. 104, 106, 159, iii. 5, vii. 89.

more abundant materials. They had resumed the ordinances of their religion, purified from their old idolatries by the Captivity, and with their zeal constantly stimulated by antagonism with the Samaritans. Politically, they were subject first to Persia, and then to Egypt; but, as long as their tribute was paid, their relations to their sovereign were kindly, and they were left to the government of their high-priests and patriarchal princes till the great Syrian persecution. The extinction of royalty, after it had served its purpose by giving an image of Messiah's kingdom, removed the chief influence which had led to apostasy in Israel and to idolatry in Judah; and the very dependence which debarred them from political freedom gave them the better opportunity for religious organization. The band by which the "people of God" were held together was at length felt to be religious and not local; and all the more so from the existence of large portions of the nation separate from the rest, in the great Eastern "dispersion," or in the new community formed in Egypt. The Jews incorporated in different nations still looked to Jerusalem as the centre of their faith. The boundaries of Canaan were passed; and the beginnings of a spiritual dispensation were already made.

But this process could not work unmixed good. "In the darkness of this long period, Judaism, with its stern and settled aversion to all polytheism, to Gentiles influences, gradually hardened into its rigid exclusiveness. . . . Conflicting opinions, which grew up under the Asmonæan princes into religious factions, those of the Pharisees and Sadducees, began to stir in the religious mind and heart of the people. The old Nazaritism grew toward the latter Essenism." (Milman).

The Jews restored to Palestine resumed their agricultural life on a land rendered doubly fertile by having "enjoyed her Sabbaths as long as she lay desolate, to fulfill

THE PTOLEMIES

threescore and ten years" (II Chron. 36.21); and it may be observed in passing, that the ordinance of the Sabbatic year, which had been so systematically neglected before the Captivity, was observed in the Maccabæan age. How the land was divided among the returned families we are not told; but thus much seems clear, that it soon fell chiefly into the hands of the nobles, who, becoming rapidly enriched through the fertility of the soil, resumed that course of oppression toward the poor which the old prophets had so vehemently denounced as the crying sin of their class. An order which thus sets itself above the social bonds of mutual kindness is prone to maintain its consequence against popular discontent by foreign influence; and, just as the princes of Judah headed the idolatrous and Egyptian party in the last days of the monarchy, so now they were the leaders of the Syrian and hellenizing party. Their influence, was resisted, as formerly by the prophets, so now by the priests, who headed the glorious uprising of the nation in defense of their religion. The issue of that contest proves that the nation was still sound at heart at the time of the Syrian domination.

18. *High Priests of the Jews after the Babylonian captivity.*

A. During the Persian Period

Jeshua.	Eliashib.	Johanah.
Joiakim.	Joiada.	Jaddua.

B. During the Ptolemaic and Seleucid Period

Onias I.	Onias II.	Onias, or Menelaus.
Simon the Just.	Simon II.	Jacimus, or Alcimus.
Eleazar.	Onias III.	
Manasseh.	(Joshua, or) Jason.	

C. During the Maccabean Period

Jonathan, brother of Judas Maccabeus (Asmonean).	Simon. John Hyrcanus. Aristobulus.	Alexander Jannæus Hyrcanus II. Aristobulus II.
--	--	--

NEW TESTAMENT BACKGROUNDS

D. During the Time from Roman Conquest through Herod the Great

Hyrcanus II.	Aristobulus (last of Asmoneans, mur- dered by Herod.)	Simon, father-in-law to Herod.
Antigonus.	Ananelus restored.	Matthias.
Ananelus.	Jesus, son of Faueus.	Jozarus, son of Simon.

E. New Testament Times

Eleazar.	Jonathan, son of Ananus.	Jonathan.
Jesus, son of Sie.	Theophilus, brother of Jonathan.	Ismael.
Jozarus (second time).	Simon Cantheras.	Joseph.
Annas (John 18:13).	Matthias, brother of Jonathan.	Ananus, son of Ana- nus, or Ananias.
Ishmael, son of Phabi.	Ellioneus, son of Cantheras.	Jesus, son of Gamaliel.
Eleazar, son of Auanus.	Joseph, son of Camei.	Matthias
Simon, son of Kamith.	Ananias, son of Nebedeus.	Ophilus.
Caiaphas, called also Joseph. (John 18:24)		Phannias.

SECTION II

THE MACCABEAN WAR (168-106 B.C.)

1. Revolt of Mattathias. 2. Judas Maccabaeus; His two initial victories. 3. Measures of Antiochus to destroy the Jews; Judas wins two victories. 4. Judas defeats Lysias, takes Jerusalem, and purifies the temple; the "Feast of Dedication." 5. Judas' wars with neighboring nations. 6. Judea invaded by Syrians; Bethsura captured. 7. Treachery of Antiochus Epiphanes; He is succeeded by Demetrius I. 8. Hellenizing priesthood of Onias IV; he builds a temple in Egypt. 9. Judas Maccabaeus wins decisive victory. 10. Alliance of Jews with Rome. 11. Defeat and death of Judas Maccabaeus. 12. Jonathan succeeds Judas Maccabaeus; his victory and peace. 13. Rival Syrian kings seek support of the Jews; Jonathan becomes high priest. 14. Jonathan defeats Syrians; Demetrius II, new king of Syria. 15. Jonathan made prisoner; his death. 16. Accession of Simon Maccabaeus; his triumphs and peace. 17. Last Syrian war against Judea; victory of the Jews; death of Simon Maccabaeus. 18. Succession of John Hyrcanus; victories and complete independence of Judea. 19. Dissension among the Jews; John Hyrcanus favors Sadducees over Pharisees. 20. Peaceful death of John Hyrcanus contrasted to deaths of his family. 21. Review of the Maccabean struggles in the light of patriotism and religion. 22. Religious and social progress during the Maccabean wars. 23. Literature and arts during the Maccabean revolt. 24. The Maccabeans at a glance.

THE MACCABEAN PERIOD

WATCH FOR ANSWERS
TO THESE QUESTIONS:

1. What is the origin or meaning of the names *Maccabean* and *Asmonean*?
2. What was the occupation of Mattathias?
3. What were the names of Mattathias' five sons?
4. Where did Mattathias and his sons first take refuge from the persecution at Jerusalem?
5. What did Mattathias do to the king's commissioner?
6. Who were the Assideans (or Chasidim)?
7. Who became leader after Mattathias died?
8. What command did Antiochus give to Lysias about the Jewish nation?
9. Where did Judas win some of his early victories?
10. What acts did Judas do in cleansing the Jerusalem temple?
11. What feast commemorates Judas' cleansing of the temple?
12. What city did the Syrians capture by using war elephants?
13. What Syrian king broke his peace treaty with the Jews?
14. Where did the priest Onias IV build a temple?
15. Where did Judas win his most glorious victory (over Nicanor)?
16. With what foreign power did Judas seek to make alliance? Was this alliance actually made?
17. Why did many of Judas' men desert him before his last battle?
18. Who succeeded Judas Maccabaeus as leader?
19. Did Jonathan bring peace to Judea or not?
20. What other office did Jonathan acquire, besides being king?
21. Where did Jonathan defeat the Syrians?
22. How was Jonathan made prisoner? By whom?

NEW TESTAMENT BACKGROUNDS

23. Who succeeded Jonathan as priest-ruler of Judea?
24. What strong tower (at last!) was taken by Simon?
25. Was Simon's reign mostly in peace or war?
26. Who slew Simon Maccabaeus?
27. Who succeeded Simon Maccabaeus?
28. Did Syria ever subjugate Judea again after the time of John Hyrcanus?
29. What did John Hyrcanus do to Idumea and Samaria?
30. What did John Hyrcanus do to the temple on Mt. Gerezim?
31. What religious sects had developed among the Jews by the time of John Hyrcanus?
32. Which religious sect did John Hyrcanus come to favor?
33. Did John Hyrcanus die in war or peacefully?
34. How many of the first generation of the Maccabean family (Mattathias' sons) died for their land and faith?
35. What religious doctrine was brought to distinct prominence by the suffering and martyrdom of the Maccabean period?
36. Did the Maccabeans consider that there were prophets among them?
37. Was the Mosaic law followed in the Maccabean period?
38. How important was the interruption of the succession to the high-priesthood during the Maccabean period?
39. What dialect or language was commonly used among the Jews of this period?
40. Which of the Maccabean rulers first issued coins?

1. *Revolt of Mattathias.*

The persecution of Antiochus Epiphanes called forth a glorious resistance, which ended in establishing the independence of Judæa under the Maccabæan or Asmonæan

princes.¹ An aged priest named MATTATHIAS, the son of Simeon (or Simon), son of Johanan (John), son of Chasmon, of the course of Joarib (the first of David's twenty-four courses), and of the house of Eleazar, Aaron's elder son, had escaped from Jerusalem at the beginning of the persecution.² He took up his abode at his own city of *Modin*³ with his five sons, John, Simon, Judas, Eleazar, and Jonathan, besides other kindred. For a time they mourned over the desolation of Jerusalem and the sanctuary; but the nearer approach of danger roused them to exertion. The king's officers, headed by Apelles, came to Modin and called first on Mattathias, as the principal man of the city, to earn honors and rewards by obeying the royal edict. But Mattathias indignantly refused, for himself, his sons, and all his kindred. Others were prepared to be more compliant; and one of them advanced to the altar to contrast his obedience with the example of rebellion. Mattathias could forbear no longer. He rushed forward, and slew first the apostate, and next the king's commissioner, on the altar itself, which he then pulled down; just as his ancestor Phinehas had slain Zimri.⁴ Having proclaimed throughout the city that all who were zealous for the law and covenant should follow him, Mattathias fled with

1. It may be well to explain these names at once. *Maccabee* was originally the surname of Judas, the third son of Mattathias. Its most probable etymology is from *Maccabah*, a *hammer*, like Charles *Martel*. *Asmonoean* (or rather *Chasmonoean*) is the proper name of the family, from Chasmon, the great-grandfather of Mattathias.

2. I Macc. 2:1; Cf. II Macc. 5:27

3. Modin (or Modi'im) is not mentioned in either Old or New Testament, though rendered immortal by its connection with the history of the Jews in the interval between the two. It was the native city of the Maccabaeian family (I Macc. xiii. 25), and as a necessary consequence contained their ancestral sepulchre (ii. 70, ix. 19). Mattathias himself, and subsequently his sons Judas and Jonathan, were buried in the family tomb, and over them Simon erected a structure which is minutely described in the Book of Maccabees (xiii. 25-30), and, with less detail, by Josephus (*Ant.* xiii. 6, 6). The site of Modin lies about 18 miles N.W. of Jerusalem, nearly on a line between Jerusalem and Joppa, on the edge of the coastal plain of Philistia.

4. I Macc. 2:15-26, 54; Comp. Num. 25:7-8, 14.

his sons to the mountains; and was joined by "many that sought after justice and judgment." The destruction of a thousand of the fugitives, who would not break the Sabbath by fighting, led Mattathias and his friends to declare the lawfulness of self-defense upon the Sabbath. Among their first adherents were the Assidœans (*Chasidim*, *pious*, or *holy*), a sect or society who had bound themselves by a special vow to the observance of the law.⁵ Issuing from their mountain-fastnesses, they broke down the heathen altars, and killed many of the worshippers, while others fled to the Syrians; they circumcised children by force, and recovered many copies of the law. But the work was too arduous for the aged Mattathias. After a noble exhortation to his sons, encouraging them by the examples of the ancient worthies, from Abraham to Daniel, and having appointed his son Judas his successor, he died, and was buried at Modin, in the sepulchre of his fathers (167 B.C.) (I Macc. 2:49-70).

2. *Judas Maccabæus; his two initial victories.*

JUDAS, the third and most warlike of the sons of Mattathias, and hence surnamed MACCABÆUS (the *Hammerer*), proved to Judæa what Alfred was to England, and Bruce to Scotland. His noble character, which the historian de-

5. *Chasidim* (i.e. the *pious* "puritans"), was the name assumed by a section of the orthodox Jews (1 Macc. ii. 42; 1 Macc. vii. 13; 2 Macc. xiv. 6), as distinguished from "the impious" "the lawless" "the transgressors", that is, the hellenizing faction. They appear to have existed as a party before the Maccabæan rising, and were probably bound by some peculiar vow to the external observance of the Law (1 Macc. ii. 42). They were among the first to join Mattathias (1 Macc. l. c.); and seem afterward to have been merged in the general body of the faithful (2 Macc. xiv. 6). The name *Chasidim* occurs frequently in the Psalms (e. g. Ps. lxxix. 2—1 Macc. vii. 17; exxxii. 9, etc.); and it has been adopted in recent times by a sect of Polish Jews, who take as the basis of their mystical system the doctrines of the Cabalistic book *Zohar*. Some historians see in the *Chasidim* the prototype of the sect of the Pharisees.

cribes in glowing terms, commanded the cheerful submission of his brethren and friends. He carried on his father's course of operations in which he seems already to have been the chief leader under him.⁷ Venturing privately into the towns, Judas and his friends gathered an army of about 6000 worshippers of Jehovah.⁸ After training his followers by night attacks and surprises⁹, he defeated the army of Apollonius, who marched against him from Samaria, slew the general, and ever afterward wore his sword.¹⁰ Another great host, led by Seron, the governor of Cœlesyria, was routed in the passes of Beth-horon, after a noble address of Judas before the battle. The Syrians fled, with the loss of about 800 men, down the pass to the plain of the Philistines, just as the Canaanites had fled Joshua over the same ground.¹¹

3. *Measures of Antiochus to destroy the Jews; Judas wins two great victories.*

Antiochus was the more enraged at the news as his finances were in disorder. The hellenizing policy, which he had pursued as rashly in other provinces as in Judæa, had created wide-spread disaffection, and Armenia and Persia, in particular, had refused to pay tribute. He called out all his forces; and, having exhausted his treasure in giving them a year's pay in advance, he marched into Persia to recruit his finances, leaving half his forces to Lysias, a noble of the royal blood, whom he made his lieutenant west of the Euphrates, and guardian of his infant son, Antiochus. Lysias, having been commissioned to extirpate *the whole* Jewish nation, gave his orders to Ptolemy

7. 1 Macc. iii. 1-9; comp. 2 Macc. v. 27, where he alone is mentioned as escaping from Jerusalem to the mountains.

8. 2 Macc. viii. 1.

9. 2 Macc. viii. 5-7.

10. 1 Macc. iii. 10-12.

11. 1 Macc. iii., 13-24.

Macron, the governor of Coësyria, who sent forth Nicanor and Gorgias, with 40,000 infantry and 7000 cavalry. Judas assembled his 6000 men at the ancient sanctuary of Mizpeh (Jerusalem being still in the hands of Philip), and after solemn religious services, he proclaimed, like Gideon, that all who were timid, as well as those who were exempt by the law from military service, might leave the camp, and encouraged the rest for the battle of the morrow.¹²

During the night, Gorgias marched out of the Syrian camp at Emmaus, with 5000 foot and 1000 chosen horse, to surprise the Jewish camp. Hearing of the movement, Judas left his camp, and appeared at day-break in the plain, with his army now weeded to 3000 men, who "had neither armor nor swords to their minds." This Syrian army under Nicanor was routed, and pursued to Ashdod and Jamnia, with the loss of 3000 men. Judas recalled his little army to meet Gorgias, who, finding the Jewish camp deserted, had advanced into the mountains. Learning the victory of the Jews by the smoke of Nicanor's camp, the followers of Gorgias fled. Besides the rich spoils of the Syrian camp, "much gold and silver, and blue silk and purple of the sea, and great riches," there were found a number of merchants from the maritime cities, who had been attracted by Nicanor's promise to sell his prisoners for slaves: these, by a just retribution, were themselves sold into slavery. Having kept the Sabbath which followed the victory with great thanksgivings, Judas crossed the Jordan, and defeated Timotheus and Bacchides, slaying above 20,000 Syrians, and taking many of the strongholds of Gilead (167 B.C.).¹³

12. 1 Macc. iii. 27-60.

13. I Macc. 4:1.

4. *Judas defeats Lysias, takes Jerusalem, and purifies the temple; "Feast of Dedication."*

In the following year Lysias, with an army of 60,000 chosen foot and 5000 horse, advanced to Bethsura,¹⁴ where he was met by Judas with only 10,000 men. After his usual fervent prayers and an animating harangue, Judas fell upon the Syrians, and defeated them with the slaughter of 5000 men; and Lysias retreated to Antioch to gather fresh forces. This victory gave the patriots possession of Jerusalem, except the Syrian tower, and Judas employed the respite from incessant war in cleansing the temple, the deserted courts of which were overgrown with tall shrubs, and the chamber of the priests thrown down. The sacred vessels were replaced from the Syrian booty, and the sanctuary was dedicated anew on the 25th of Chisleu, exactly three years after its profanation (Dec. B.C. 166). A festival was kept for eight days, with rejoicings similar to those of the Feast of Tabernacles; the solemnity was made a perpetual institution, and this is the "Feast of the Dedication" mentioned by St. John as being kept in the winter.¹⁵ During this solemnity, Judas had to employ a part of his forces to keep in check the Syrians, who still held the tower on Mount Zion. He afterward secured the temple against attacks from that quarter by the erection of a strong wall and towers, well manned. He also fortified and garrisoned Bethsura.¹⁶

Modern Jews still commemorate the purification of

14. Beth-zur (*house of the rock*) was a town in the mountains of Judah (Josh. 15:58), a fortress of Rehoboam (2 Chr. 11:7), and a place of great importance, as we shall see repeatedly, in the Maccabean wars. The identification of the site of Beth-zur under the almost identical name of *Beitsur*, by Wolcott and Robinson explains its impregnability, and also the reason for the choice of its position, since it commands the road from Beersheba and Hebron, which has always been the main approach to Jerusalem from the south.

15. I Macc. 4, II Macc. 10:1-8; John 10:22.

16. I Macc. 4:60-61.

the temple by Judas during *Hanukkah*, or the Feast of Lights.

5. *Judas' wars with neighboring nations.*

These successes roused the old jealous enmities of the surrounding nations, who began to massacre the Jews that dwelt among them; but Judas was as prompt to chastise as to deliver. He made a descent on Joppa, and burned many houses and ships, to avenge the treacherous murder of 200 Jews, who had been decoyed on board the vessels in the harbor, and there drowned; and another treacherous massacre at Jamnia was punished by the conflagration of the town and ships, whose flames were seen from Jerusalem, a distance of twenty-five miles.¹⁷ He had returned to Judæa from a campaign against the Idumæans and the Ammonites, when letters arrived announcing the extreme danger of the Jews in Gilead and Galilee. Judas divided his forces, sending his brother Simon into Galilee, while he marched with Jonathan into Gilead. Both expeditions were successful, and future dangers were guarded against by the removal of the Galilean and Transjordanic Jews to Jerusalem. In the mean time, Joseph and Azarias, who had been left at Jerusalem with strict orders not to fight, were tempted by the news of these victories to attack Gorgias at Jamnia. They were routed with the loss of 2000 men; but this heavy blow increased the confidence of the people in the Maccabæan brothers as their only worthy leaders; and another slight reverse confirmed the prudence by which Judas regulated his valor. He revenged the defeat, not without considerable loss. When they proceeded, after ob-

17. 2 Macc. 12:9. Jamnia or Jabnia (in Hebrew *Jabneel*) is an important place in the Maccabæan war. It was on the northern boundary of Judah, between Ashdod and Joppa, not quite at the sea, though near it (Josh. 15:11). At the time of the fall of Jerusalem, Jabneh was one of the most populous places of Judæa, and contained a Jewish school of great fame, whose learned doctors are often mentioned in the Talmud.

-serving the Sabbath in Adullam, to bury the dead, small idols were found in the clothes even of some of the priestly race. A sin-offering was sent to Jerusalem, not only to atone for the guilt of these men, but for the dead, in whose resurrection the Maccabæan Jews, no doubt the Chasidim, had full faith.¹⁸ He finished the campaign by reducing Hebron, and overrunning the Philistine country and Samaria.¹⁹

6. *Judea invaded by Syrians; Bethsura captured.*

About this time Antiochus Epiphanes died, in the manner already described. His young son, ANTIOCHUS V. EUPATOR (164-162 B.C.), was placed on the throne by Lysias, and a new campaign was undertaken for the relief of the Syrian garrison, who were now besieged in the citadel of Zion. The king and Lysias laid siege to Bethsura, while Judas hastened to its relief. The Syrian army numbered 80,000 or 100,000 foot soldiers, 20,000 horsemen, and 32 elephants. These beasts, now for the first time mentioned in Jewish warfare, are described as escorted each by 1000 foot soldiers and 500 horsemen; each bore a tower containing 32 men, an exaggeration significant of the alarm caused by the strange sight: and it was believed that they were provoked to fight by the sight of the blood of grapes and mulberries. But the courage of the Jewish patriots was stimulated by the noble example of ELEAZAR, surnamed Avaran, the fourth of the Maccabæan brothers, who crept under an elephant and killed it, but was crushed to death by its fall. Nor did his self-devotion ensure the victory: Judas was compelled to retreat to Jerusalem, and Bethsura capitulated on favorable terms. The fall of the fortress is ascribed to famine, in consequence of the dearth of corn

18. 2 Macc. 12:44. "For if he had not hoped that they that were slain should have risen again, it had been superfluous and vain to pray for the dead."

19. 1 Macc. 5.

in the Sabbatic year—an incidental proof of the observance of that institution by the restored Jews (163 B.C.). The same cause reduced Jerusalem, which was next besieged, to the last extremities of famine, but drove the besiegers also to straits.

7. *Treachery of Antiochus Eupator; he is succeeded by Demetrius I.*

Meanwhile, however, the army which Antiochus Epiphanes had led into Persia returned under Philip, who claimed the guardianship of the young king. Upon this Lysias advised Antiochus to make peace with the Jews. The king was no sooner admitted into the city, than he broke the terms just made by pulling down the new wall of Judas; after which he retired to Antioch, and recovered the capital from Philip. His triumph was brief, for Demetrius, the son of Seleucus IV.—whose rightful inheritance had been usurped by his uncle, Antiochus Epiphanes—returned from Rome, where he had been a hostage, overthrew and put to death Antiochus and Lysias, and became king by the title of DEMETRIUS I. SOTER²⁰ (162-150 B.C.). With more subtle policy than his predecessor, Demetrius availed himself of the divisions among the Jews. The common people appear to have become discontented under the austere yoke of the Assidæans, and impatient of the long sacrifices demanded in the cause of patriotism; and for the first time the hellenizing party was headed by a high-priest, Onias IV, who, unlike the usurpers, Jason and Menelaus, might plead a legitimate title.

8. *Hellenizing priesthood of Onias IV; he builds a temple in Egypt. Alcimus priest in Jerusalem.*

Onias III., whose death at Antioch by the artifices of

20. I Macc. 6.

THE MACCABEAN PERIOD

Menelaus has been related, left a son of the same name, who, though he never exercised the high-priesthood at Jerusalem, may be called Onias IV., to avoid confusion. During the usurpation of Jason and Menelaus, Onias seems to have supported an alliance with Egypt, whither he at length fled, and was protected by Ptolemy Philometor. As the legitimate heir to the high-priesthood, he formed the project of reviving in Egypt the worship which had been desecrated in Judæa. Egypt seemed well fitted to form a new centre of hellenistic Judaism by the great number of Jews who had settled there at various times, and by the possession of the Septuagint version of the Scriptures. Onias therefore built a temple, of which he and his family became high-priests; so that there were now three temples, the true one at Jerusalem, the Samaritan on Mount Gerizim, and the hellenistic in Egypt.²¹

One consequence of the secession of Onias was that, on the execution of Menelaus by order of Antiochus Eupator (about 163 B.C.), the high-priesthood of Jerusalem passed out of the line of Jozadak, the father of Jeshua, in which it had remained since the return from the Captivity. Antiochus appointed Joakim²² (Jacimus), who, as Josephus says, was indeed of the stock of Aaron, but not of this family. ALCIMUS, for such was the Greek name which the new high-priest adopted, became the head of the hellenizing party, and courted Demetrius, who sent an army under Bacchides to set up the high-priest at Jerusalem. Their overtures of peace could not deceive Judas; but the Assidæans trusted to the sacred character of the high-priest, who repaid their confidence by killing sixty of them in one day.²³

21. Josephus, *Ant.* XIII, 3. *Wars*, I, 1, 1; VII, 10, 2. The site of this temple is uncertain.

22. A name equivalent to *Elialcim* (*God hath set up*), in Greek *Alcimus*. Joseph. *Ant.* XII, 9, 5, I Macc. 7:14.

23. I Macc. 7:1-18.

9. *Judas Maccabæus wins decisive victory.*

Bacchides returned to Antioch, leaving the high-priest as governor; while the indefatigable Judas went through the cities of Judah rallying the patriots. Alcimus again repaired to Antioch for help; and Nicanor, who was sent to restore him, was defeated by Judas at Capharsalama. He retired to the citadel of Zion, where his refusal to listen to the overtures of the priests until Judas was delivered up to him, and his ferocious cruelties, reunited the patriots in resistance and prayer for his overthrow. A battle ensued at ADASA, near Bethhoron, where Judas gained his most glorious victory, on the 13th of Adar (end of February, 161 B.C.), a day which was kept as a national festival. Nicanor was slain, and his head and hand were exposed as trophies at Jerusalem. The independence of Judæa was won, though it was not finally secured till after several years of contest, and the death of all the Maccabæan brothers. Meanwhile the land enjoyed a brief interal of rest.²⁴

10. *Alliance of Jews with Rome.*

It is at this juncture that the name of ROME first appears in Jewish history. The imagination of Judas was captivated by the successes she had gained against the Gauls and Spaniards, and especially over those Greek powers with which he was so fiercely struggling. He had heard of their defeats of Philip, Perseus, and Antiochus the Great, and of their power to set up and cast down kings; but he seems to have been most attracted by their republican form of government.²⁵ He sent to Rome Eupolemus the son of John, with Jason the son of ELEAZAR, to propose a league against Syria; and the envoys brought back a letter, inscribed on brazen tablets, containing the articles of alliance between

24. I Macc. 7:19-50; II Macc. 15:36.

25. I Macc. 8:1-16.

THE MACCABEAN PERIOD

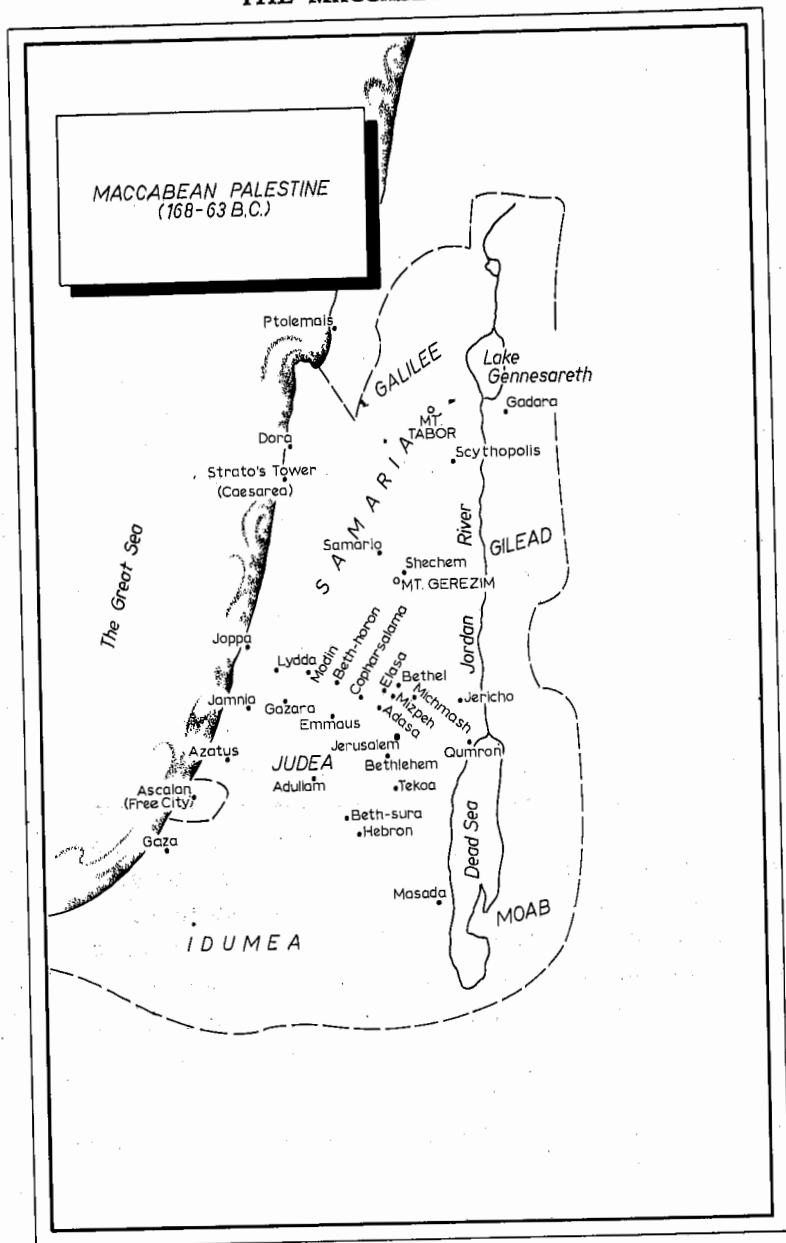

the Romans and the Jews.²⁶ But before they reached Judæa, the career of Judas was closed; gloriously indeed, but in a manner which we can scarcely doubt that one of the old prophets would have regarded as a judgment for seeking strength from a heathen alliance, as the only error of his life.

11. *Defeat and death of Judas Maccabæus.*

Demetrius had sent his whole force, under Bacchides, to restore Alcimus and avenge Nicanor. The treaty with Rome seems to have offended the extreme party of the Assidæans; and Judas had only 3000 men to oppose to the enemy's 20,000 foot and 2000 horse. Their camp was at "Berea" (probably Beeroth), and his at "Eleasa."²⁷ His men, terrified by the disparity of numbers, continued to desert, till only 800 remained. These urged Judas to fly, and wait for a better opportunity. His reply shows that prophetic instinct which has often warned a hero of coming death:—"If our time be come, let us die manfully for our brethren, and let us not stain our honor!" He took post, with his chosen warriors, over against the right wing of the Syrians, where Bacchides commanded. He defeated this wing, the strength of the Syrian army, pursuing them to Azotus. But the Syrians on the left, scarcely meeting with opposition, fell upon the rear of the victorious Jews. The odds were overwhelming; and the disaster was crowned by the death of Judas, whereupon his followers fled. His brothers, Jonathan and Simon, recovered his body, and buried him in his father's sepulchre at Modin, amidst the

26. I Macc. 8:17-32.

27. I Macc. 9:1-5. The Vulgate has *Laisa*. The position is very uncertain. Some propose to identify it with *Laish*, and even with *Adasa*. It seems to have been on the west slope of the mountains of Judah, above Ashdod (v. 15). The attacks of the Syrians during this war were chiefly made from that side.

lamentations of all Israel, as they cried, "How is the valiant man fallen that delivered Israel!"²⁸

The best eulogy of Judas Maccabæus is the simple record of his deeds, of which his historian assures us that they were too many to be written.²⁹ "Among those lofty spirits," says Dean Milman, "who have asserted the liberty of their native land against wanton and cruel oppression, none have surpassed the most able of the Maccabees in accomplishing a great end with inadequate means; none ever united more generous valor with a better cause:" none, we may add, more completely gave God the glory. There is at least one worthy tribute to his honor in the splendid oratorio of Handel. His death occurred in 161 B.C.

12. *Jonathan succeeds Judas Maccabæus;
his victory and peace.*

The triumph of Bacchides and the "impious" faction was aided by the distress of a great famine, and the friends of Judas were hunted down on every side. But, as before, this want of moderation compelled resistance. JONATHAN, surnamed Apphus (the *wary*), the fifth and youngest son of Mattathias, was chosen leader as the most warlike of the three surviving brothers; Simon aiding him with his counsel. They established themselves in the wilderness of Tekoah, where their first exploit was to avenge their eldest brother JOHN (Johanah), surnamed Gaddis, who was treacherously killed by the Arabs, while conveying some of the effects of the patriots to the care of the Nabateans. Incensed by this deed, Bacchides, on a Sabbath, attacked their position in the marshes of the Jordan; but they escaped by swimming across the river, having slain 1000 of the Syrians (161 B.C.). Bacchides now occupied himself with fortifying Jericho, Emmaus, Beth-horon, Bethel, and other

28. I Macc. 9:6-22.

29. I Macc. 9:22.

strong cities in Judah, and he placed in them hostages from the chief families. Alcimus had set to work with equal ardor to pull down the walls round the temple, when he was struck with a palsy and died in great torment. Upon this, Bacchides returned to Antioch, and the land had rest for two years.⁸⁰ A last attempt of the hellenizing party to call in the aid of Bacchides proved their ruin; for, enraged by a defeat which he suffered from Jonathan, Bacchides put to death many of the faction who had invited him, and gave up the enterprise. Before he retreated, however, he accepted the invitation of Jonathan to make peace; restored his prisoners and hostages; and promised not again to molest the Jews, a promise which he kept. Jonathan established himself at the fortress of Michmash, so renowned in history of his great namesake, the son of Saul. There he governed the people, and "destroyed the ungodly men out of Israel."⁸¹ This state of things lasted for about six years (158-153 B.C.).

13. *Rival Syrian kings seek support of the Jews;
Jonathan becomes high priest.*

The claim of Alexander Balas, a pretended son of Antiochus Epiphanes, to the crown of Syria, led to a new advancement of Jonathan and the Jews (153 B.C.), who were courted by both rivals. Demetrius wrote first, authorizing Jonathan to raise an army, and commanding that the hostages in the tower of Zion should be delivered to him. This was at once done, and Jonathan began to repair the fortifications of Jerusalem. Meanwhile all of the hostile party fled from the fortified cities, except Bethsura. Next came the letter from Alexander, nominating Jonathan to the *high-priesthood*, which had been vacant since the death of Alcimus, and sending him a purple robe and

80. B.C. 160-158; I Macc. 9:23-57.

81. I Macc. 9:58-73.

a crown of gold. Jonathan assumed these insignia at the Feast of Tabernacles (153 B.C.), and thus began the line of the priest-princes of the Asmonæan family.³² Demetrius, in despair, now made new and unbounded offers: freedom for all the Jews of his kingdom from tribute, from the duties on salt, and from crown-taxes; and exemption from the payment of the third of the seed and the half of the produce of fruit-trees. The three governments of Apherema, Lydda, and Ramathem,³³ including the port of Ptolemais (*Acre*), were to be taken from Samaria and annexed to Judæa forever, under the sole government of the high-priest. An army of 30,000 Jews was to be raised at the king's expense, to garrison the cities and act as a police. Jerusalem, with its territory, was declared holy, free from tithe and tribute, and a place of asylum. A large annual sum was promised for the works of the temple and the fortifications of the city, and the revenues of Ptolemais were assigned for the ordinary expenses of the sanctuary. All Jewish captives throughout the Syrian empire were to be

32. It does not appear that any direct claimant to the high-priesthood remained since Onias IV the younger, who inherited the claim of his father Onias III, the last legitimate high priest, had retired to Egypt. A new and glorious succession of high-priests now arose in the Asmonæan family, who united the dignity of civil rulers, and for a time of independent sovereigns, to that of the high-priesthood. Josephus, who is followed by Lightfoot, Selden, and others, calls Judas Maccabæus "high-priest of the nation of Judah" (*Ant.* xii. 10, 6), but, according to the far better authority of 1 Macc. x. 20, it was not till after the death of Judas Maccabæus that Alcimus himself died, and that Alexander, King of Syria, made Jonathan, the brother of Judas, high-priest. Josephus himself too calls Jonathan "the first of the sons of Asamoneus, who was high-priest" (*Vita*, 1). It is possible, however, that Judas may have been elected by the people to the office of high-priest, though never confirmed in it by the Syrian kings. The Asmonæan family were priests of the course of Joarib, the first of the twenty-four courses (1 Chr. xxiv. 7), and whose return from captivity is recorded in 1 Chr. ix. 10; Neh. xi. 10. They were probably of the house of Eleazar, though this can not be affirmed with certainty; and Josephus tells us that he himself was related to them, one of his ancestors having married a daughter of Jonathan, the first high-priest of the house. This Asmonæan dynasty lasted from B.C. 153, till the family was damaged by internal divisions and then destroyed by Herod the Great.

33. Comp. I Macc. 11:34.

set free, and all the feasts were to be holidays for them. More moderate offers might have been a better proof of good faith. The Jews had more confidence in Alexander, who was moreover favored by Rome; and, after he had defeated and killed Demetrius (150 B.C.), he gave Jonathan a magnificent reception at Ptolemais, on his marriage with Cleopatra the daughter of Ptolemy Philometor.³⁴

14. *Jonathan defeats Syrians; Demetrius II, new king of Syria.*

Three years later (147 B.C.) the younger Demetrius (who afterward reigned as Demetrius II. Nicator) attempted to recover his father's kingdom; and his adherent Apollonius, governor of Cœlesyria, advanced to Jamnia and sent a challenge to Jonathan. A battle was fought near Azotus, in which the infantry of Jonathan stood firm against the Syrian cavalry, who attacked them on all sides, till the fresh forces of his brother Simon routed the wearied horsemen, who fled to the temple of Dagon at Azotus. Jonathan burned the city and temple, with the men in it to the number of 8000; and after receiving the submission of Ascalon he returned to Jerusalem.³⁵

A new enemy now took the field against Alexander, in the person of his father-in-law, Ptolemy, who marched into Syria, professedly as a friend. Jonathan met him at Joppa, and was favorably received, in spite of the accusations of his enemies. We need not here relate the alliance of Ptolemy with the young Demetrius, nor the defeat and death of Alexander, followed by the death of Ptolemy and the accession of DEMETRIUS II. NICATOR to the throne of Syria (146 B.C.). Jonathan's political tact not only brought him safe through this revolution, but gained new advantages for his country. During the confusion, he had laid

34. I Macc. 10:22-66.

35. I Macc. 10:67-89.

siege to the tower on Zion, for which act his enemies accused him to the new king, who summoned him to Ptolemais. Leaving orders to press the siege, he went with a body of priests and elders, carrying splendid presents. He gained great favor with Demetrius, who confirmed him in the high-priesthood; and a present of 300 talents to the king secured for Judæa most of the privileges which had been promised by Demetrius I.

The unpopularity of Demetrius, in consequence of his disbanding the Syrian troops and replacing them by mercenaries whom he had brought with him from Crete, opened the door to the schemes of TRYPHON, who claimed the throne for Antiochus, son of Alexander Balas. Jonathan seized the opportunity to obtain from Demetrius a promise of the evacuation of the long-contested tower, and sent him a body of 3000 Jews, who saved his life in a tumult at Antioch. But the immediate danger was no sooner past, than Demetrius became estranged from Jonathan, and failed to fulfill his promises.⁸⁶

15. *Jonathan made prisoner; his death.*

The defeat of Demetrius by Tryphon placed ANTI- OCHUS VI. THEOS on the throne (144 B.C.). Jonathan was confirmed in all his honors, and his brother Simon was made captain-general of the country from the Ladder of Tyre to the borders of Egypt. Gaza and Bethsura were reduced, and Jonathan defeated the partisans of Demetrius near the lake Gennesareth⁸⁷ (Sea of Galilee), and again in the region of Hamath, and advanced as far as Damascus; while Simon secured Ascalon and took Joppa.⁸⁸ Having renewed the alliance with Rome, and also, if we may trust our leading authority, with the Lacedæmonians,⁸⁹ Jonathan

86. I Macc. 11:1-53.

87. I Macc. 11:54-74.

88. I Macc. 12:24-34.

89. I Macc. 12:1-28.

summoned the elders to fortify the cities of Judæa, to heighten the walls of Jerusalem, and to block out the tower on Zion by a great mound from the city and the temple. They were engaged on this work when Tryphon, who was plotting an usurpation, and regarded Jonathan as his chief obstacle, enticed him to Ptolemais, with a guard of only 1000 men, who were slain, and Jonathan was made prisoner.⁴⁰

The enemies of the Jews now rose in every quarter; but Simon was acknowledged as leader, and marched to Adida to meet Tryphon, who was advancing to invade Judæa. When Tryphon found with whom he had to do, he opened negotiations. Pretending that Jonathan had been seized for money due to the king, he promised to release him on the payment of 100 talents of silver and the delivery of two of his sons as hostages. Simon expected treachery; but, lest his motives should be mistaken, he accepted the terms. Tryphon verified his fears; and, after being foiled by Simon in all his attempts to advance to Jerusalem and relieve the Syrian garrison, he marched into Gilead, still carrying Jonathan with him, and killed and buried him at Bascama. On his retiring to Antioch, Simon removed the bones of Jonathan to Modin, where he built a stately monument, with seven obelisks for Mattathias, his wife, and their five sons; the whole forming a sea-mark for passing ships.⁴¹

16. *Accession of Simon Maccabæus; his triumphs and peace.*

SIMON, surnamed Thassi, the second son of Mattathias, and the last survivor of his brethren, was high-priest from 143 B.C. to 135 B.C. His wisdom and valor had aided Judas and Jonathan through the long contest, which now needed only one last effort to secure its fruits. Tryphon, occupied

40. I Macc. 12:35-52.

41. I Macc. 13:1-30.

with his own schemes of usurpation, seems to have renounced all attacks upon Judæa, except predatory incursions as he found opportunity. Simon employed himself in restoring the strongholds, and sought the friendship of Demetrius, who granted the independence of Judæa. The first year of Simon became an epoch from which people dated contracts and other instruments.⁴² After taking Gaza, he broke off the last and heaviest link of the Syrian fetters by the reduction, through famine, of the tower of Jerusalem.⁴³ It was purified and solemnly entered on the 23d of the second month (May, 142 B.C.), which was made an annual festival. John, the second son of Simon, was made captain of the host, and was posted at the fortress of Gazara.⁴⁴

Neither the capture of Demetrius by the Parthians, nor the completion of Tryphon's usurpation by the murder of Antiochus Theos, disturbed the peace which Judæa enjoyed under Simon. "Then did they till their ground in peace, and the earth gave her increase, and the trees of the field their fruit. The ancient men sat in all the streets, communing together of good things, and the young men put on glorious and warlike apparel. He provided victuals for the cities, and set in them all manner of munition, so that his honorable name was renowned unto the end of the world. He made peace in the land, and Israel rejoiced with great joy. . . . He beautified the sanctuary, and multiplied the vessels of the temple." While his internal government was just and firm, he opened up a commerce with Europe through the port of Joppa, and renewed the treaties with Rome and Lacedæmon. The letters in favor of the

42. 1 Macc. 13:33-42. It was not, however, till the fifth year of his son, John Hyrcanus, that the final recognition of Jewish independence was made by Syria.

43. The leveling of the hill on which the tower had stood, so that it should no longer command the temple, has affected the topography of Jerusalem.

44. I Macc. 13:43-53.

Jews, addressed by the Roman Senate to the states and islands of Greece and Asia Minor, and to the great potentates of Asia, including even the Parthian Arsaces, are a striking evidence of the wide diffusion of the Jewish race.⁴⁵ A lasting memorial of Simon's services and of the gratitude of his country was inscribed on tablets of brass and set up in Mount Zion.⁴⁶

17. *Last Syrian war against Judea; victory of Jews; death of Simon Maccabaeus.*

Tryphon's usurpation was at length challenged by ANTIOCHUS VII. SIDETES, second son of Demetrius I., and brother of the captive Demetrius II, who made unbounded promises to the Jews. He quickly defeated Tryphon, and besieged him in Dora,⁴⁷ whither Simon sent him 2000 men, with abundance of money and arms. But Antiochus, from jealousy of Simon's power and wealth, refused the proffered aid, and sent Athenobius to demand Joppa and Gazara,⁴⁸ besides 1000 talents for the places taken and the tribute withheld from Syria. Simon refused, but offered 100 talents as a compensation for Joppa and Gazara; and Antiochus commenced the *last war* which the Maccabees had to wage with Syria. While the king pursued Tryphon, who had escaped from Dora, his general, Cendebeus, appointed commander of the sea-coast, took up his post at Jamnia, and harassed the Jews with constant attacks.⁴⁹ Simon, being now too old to take the field, sent

45. I Macc. 14:1-34; 15:15-24.

46. I Macc. 14:25-49.

47. Dora, one of the seacoast cities which acquired a peculiar importance in the Maccabean, Herodian, and Roman periods, was the ancient DOR, a royal city of the Canaanites (Josh. 11:1-2; 12:23). It lay twelve miles south of Mt. Carmel.

48. Gazara is almost certainly the same place as the hill more anciently called GEZER (I Kings 9:15-17). It is a large mound on the north end of the Shephelah, overlooking the plain at Philistia, about eighteen miles southeast of Joppa.

49. I Macc. 15.

his two eldest sons, Judas and John, with 20,000 men and some horses, who gained a complete victory over the vast forces of Cendebeus. After this success, it might have been expected that Simon would have died in a peaceful old age; but he was not exempted from the violent end of all his brothers. On a trip through the country with his sons Judas and Mattathias, he arrived at Jericho, where he was received by the governor, Ptolemy the son of Abubus, his own son-in-law, and a man of great wealth. In pursuance of a design to make himself master of Judæa, Ptolemy caused Simon and his two sons to be slain treacherously at a banquet. John, who was at Gazara, warned in time, slew the men who were sent to kill him⁵⁰ (135 B.C.).

With the death of the last of the sons of Mattathias, we lose the authentic record of the *First Book of Maccabees*, and Josephus becomes almost our only guide. The acts of John Hyrcanus were written in the *Chronicles of his Priesthood*, a work older than the *First Book of Maccabees*.⁵¹

18. *Succession of John Hyrcanus; victories and complete independence of Judea.*

JOHN HYRCANUS, the second son of Simon, under whom he had been commander of the army, succeeded his father in the priesthood and government, which he held for thirty years (135-106 B.C.). He at once went from Gazara to Jerusalem; and after the people had accepted him for their leader, he marched against Jericho. Ptolemy, who held a strong fort near the city, tried to deter him from an assault by savage cruelties to his mother and brothers. They were scourged upon the walls, whence Ptolemy threatened to throw them headlong; and though John's mother exhorted him to disregard their sufferings, the intended effect was produced. John retired; the siege, after

50. I Macc. 16.

51. I Macc. 15:24.

being protracted for a year, was abandoned; and Ptolemy fled to Philadelphia beyond the Jordan, after which we hear of him no more. Meanwhile the army of Antiochus proved too strong for John. He was besieged in Jerusalem, and was compelled by famine to give up the city, on the conditions of dismantling the fortifications and returning to a tributary state (133 B.C.). The moderation of Antiochus on this occasion, and his respect for the Jewish religion, gained him the surname of *Eusebes* (the *Pious*). Hyrcanus was treated by him with favor, and attended him on the expedition which the king made against Parthia ostensibly to release his imprisoned brother Demetrius Nicator (128 B.C.). The death of Antiochus in this campaign gave an opportunity for recovering the independence of Judæa, which was never again subjugated by Syria. The latter monarchy indeed became, till its absorption into the Roman empire (65 B.C.), the victim of such dynastic revolutions, that its history is henceforth as unimportant for us, as it is intricate to follow. The Jews once more entered on a course of conquest, limited indeed, but most gratifying to their pride in the humiliation of their ancient and more recent enemies. After carrying his arms into the region east of Jordan, where he took two cities, Hyrcanus subdued both Idumæa and Samaria, the hated rivals of Israel before and after the Captivity. The Idumæans were compelled to adopt the Jewish religion, and to receive circumcision; and the conquest was so complete that the kingdom of Idumæa disappears from history: and yet the unconquerable race of Edom soon proved the inheritance of its forefather's blessing by giving a new dynasty to Judæa. In Samaria, John Hyrcanus completed his triumph by destroying the hated schismatic temple on Mount Gerizim. The sanctuary on Mount Zion thus regained its pre-eminence in the Holy Land, and the Jews once more imposed upon the Samaritans the sacred law, "that Jerusalem is the place

where men ought to worship." The reduction of Samaria was effected by Aristobulus and Antigonus, the sons of John Hyrcanus, in the 26th year of his rule (109 B.C.). The city of Samaria was utterly destroyed, and its site converted into pools of water from its own abundant springs. Most of Galilee submitted to the authority of the high-priest, who again renewed the alliance of his family with Rome. Of his buildings at Jerusalem, the most important was the *Tower of Baris*, at the N.W. corner of the enclosure of the Temple. It was afterward the *Antonia* of Herod.

19. *Dissension among the Jews; John Hyrcanus favors Sadducees over Pharisees.*

Thus the Holy Land under the name of Judæa was restored to its ancient limits, and the people enjoyed their worship under a race of priest-princes who held their authority in submission to the divine law. But no human affairs ever reached the climax of prosperity without taking the downward turn; and it was taken with frightful rapidity by the successors of John Hyrcanus, who displayed a personal ambition unknown to the pure patriotism of the Maccabees, and were soon engaged in fierce contests for the supreme power. Then began those family murders, which form the most horrid feature of Oriental despotism, and which reached their climax under Herod. One chief source of these evils was the rupture of the religious unity of the nation, by the rise of the opposing sects of the PHARISEES and SADDUCEES, which, springing from a doubtful origin, and from causes long at work, had become established during the government of John Hyrcanus. Toward the end of his reign, Hyrcanus, provoked by an insult from one of the leading Pharisees, joined the party of the Sadducees, a step which left a heritage of trouble to his successors. "The cause of this rupture," says Dean

Milman, "is singularly characteristic of Jewish manners. During a banquet, at which the chiefs of the ruling sect were present, Hyrcanus demanded their judgment on his general conduct and administration of affairs which he professed to have regulated by the great principle of justice (the *righteousness* which was the watch-word of the Pharisees) and by strict adherence to the tenets of their sect. The Pharisees with general acclamation testified their approval of all his proceedings; one voice alone, that of Eleazar, interrupted the general harmony:—'If you are a just man, abandon the high-priesthood, for which you are disqualified by the illegitimacy of your birth.' The mother of Hyrcanus had formerly it was said, though according to Josephus falsely, been taken captive and thus exposed the polluting embraces of a heathen master. The indignant Hyrcanus demanded the trial of Eleazar for defamation. By the influence of the Pharisees he was shielded, and escaped with scourging and imprisonment. Hyrcanus, enraged at this unexpected hostility, listened to the representations of Jonathan, a Sadducee, who accused the rival faction of a conspiracy to overawe the sovereign power; and from that time he entirely alienated himself from the Pharisaic councils."

20. *Peaceful death of John Hyrcanus contrasted to deaths of his family.*

John Hyrcanus died exactly sixty years, or the space of two complete generations, after his grandfather Mattathias (106 B.C.). As he began a new generation of the Maccabæan house, so was he the first who escaped the violent end to which his father and uncles had succumbed. His death marks the transition from the theocratic commonwealth under the Maccabæan leaders to the Asmonæan kingdom, which was established by his son Judas, or Ari-

stobulus, whose Greek name is but too significant of the hellenizing character of the new era.

The only two of the first generation of the Maccabæan family who did not obtain to the leadership of their countrymen like their brothers yet shared their fate—Eleazar by a noble act of self-devotion, John, apparently the eldest brother, by treachery. The sacrifice of the family was complete; and probably history offers no parallel to the undaunted courage with which such a band dared to face death, one by one, in the maintenance of a holy cause. The result was worthy of the sacrifice. The Maccabees inspired a subject-people with independence; they found a few personal followers, and they left a nation.

21. *Review of the Maccabean struggles in the light of patriotism and religion.*

The great outlines of the Maccabæan contest, which are somewhat hidden in the annals thus briefly epitomized, admit of being traced with fair distinctness, though many points must always remain obscure from our ignorance of the numbers and distribution of the Jewish population and of the general condition of the people at the time. The disputed succession to the Syrian throne (153 B.C.) was the political turning-point of the struggle which may thus be divided into two great periods. During the first period (168-153 B.C.) the patriots maintained their cause with varying success against the whole strength of Syria; during the second (153-139 B.C.), they were courted by rival factions, and their independence was acknowledged from time to time, though pledges given in times of danger were often broken when the danger was over. The paramount importance of Jerusalem is conspicuous throughout the whole war. The loss of the Holy City reduced the patriotic party at once to the condition of mere guerrilla bands,

issuing from "the mountains" or "the wilderness," to make sudden forays on the neighboring towns. This was the first aspect of the war⁵²; and the scene of the early exploits of Judas was the hill-country to the N.E. of Jerusalem, from which he drove the invading armies at the famous battle-fields of Beth-horon and Emmaus (Nicopolis). The occupation of Jerusalem closed the first act of the war (166 B.C.); and after this Judas made rapid attacks on every side—in Idumæa, Ammon, Gilead, Galilee—but he made no permanent settlement in the countries which he ravaged. Bethsura was fortified as a defense of Jerusalem on the south; but the authority of Judas seems to have been limited to the immediate neighborhood of Jerusalem, though the influence of his name extended more widely.⁵³ On the death of Judas, the patriots were reduced to as great distress as at their first rising; and as Bacchides held the keys of the "mountain of Ephraim," they were forced to find a refuge in the lowlands near Jericho, and after some slight successes Jonathan was allowed to settle at Michmash undisturbed, though the whole country remained absolutely under the sovereignty of Syria. So far it seemed that little has been gained when the contest between Alexander Balas and Demetrius I. opened a new period (153 B.C.). Jonathan was empowered to raise troops; the Jewish hostages were restored; many of the fortresses were abandoned; and apparently a definite district was assigned to the government of the high-priest. The former unfruitful conflicts at length produced their full harvest. The defeat at Eleasas had shown the worth of men who could face all odds, and no price seemed too great to secure their aid. When the Jewish leaders had once obtained legitimate power, they proved able to maintain it though their general success was checkered by some reverses. The solid power of the na-

52. II Macc. 8:1-7; I Macc. 2:45.

53. I Macc. 7:50.

THE MACCABEAN PERIOD

tional party was seen by the slight effect which was produced by the treacherous murder of Jonathan. Simon was able at once to occupy his place and carry out his plans. The Syrian garrison was withdrawn from Jerusalem; Joppa was occupied as a sea-port; and "four governments"⁵⁴ probably the central parts of the old kingdom of Judah, with three districts taken from Samaria⁵⁵ were subjected to the sovereign authority of the high-priest.

The war thus brought to a noble issue, if less famous, is not less glorious than any of those in which a few brave men have successfully maintained the cause of freedom of religion against overpowering might. For it is not only in their victory over external difficulties that the heroism of the Maccabees is conspicuous: their real success was as much imperiled by internal divisions as by foreign force. They had to contend on the one hand against open and subtle attempts to introduce Greek customs, and on the other against an extreme Pharisaic party, which is seen from time to time opposing their counsels.⁵⁶ And it was from Judas and those whom he inspired that the old faith received its last development and final impress before the coming of our Lord.

That view of the Maccabean war, which regards it only as a civil and not as a religious conflict, is essentially one-sided. If there were no other evidence than the book of Daniel, that alone would show how deeply the noblest hopes of the theocracy were centred in the success of the struggle. When the feelings of the nation were thus again turned with fresh power to their ancient faith, we might expect that there would be a new creative epoch in the national literature; or, if the form of Hebrew composition was already fixed by sacred types, a prophet or psalmist would express the thoughts of the new age after the models

54. I Macc. 11:57; 13:37.

55. I Macc. 10:38, 39.

56. I Macc. 7:12-18.

of old time. Yet in part at least the leaders of Maccabæan times felt that they were separated by a real chasm from the times of the kingdom or of the exile. If they looked for a prophet in the future, they acknowledged that the spirit of prophecy was not among them.⁵⁷ The volume of the prophetic writings was completed, and, as far as appears, no one ventured to imitate its contents. But the Hagiographa,⁵⁸ though they were already long fixed as a definite collection, were not equally far removed from imitation. The apocalyptic visions of Daniel served as a pattern for the visions incorporated in the book of Enoch. Two books resembling Proverbs—*The Wisdom of Solomon* and *Ecclesiasticus*—appeared during this time.

22. *Religious and social progress during the Maccabean wars.*

The history of the Maccabees does not contain much which illustrates in detail the religious or social progress of the Jews. It is obvious that the period must not only have intensified old beliefs, but also have called out elements which were latent in them. One doctrine at least, that of a resurrection, and even of a material resurrection,⁵⁹ was brought out into the most distinct apprehension by suffering. "It is good to look for the hope from God, to be raised up again by him," was the substance of the martyr's answer to his judge; "as for thee, thou shalt have no resurrection to life."⁶⁰ "Our brethren," says another, "have fallen, having endured a short pain leading to everlasting life, being under the covenant of God."⁶¹ And as it was believed that an interval elapsed between death and judg-

57. I Macc. 9:27.

58. The *Hagiographa* is the Greek name for the third part of the Hebrew Bible, consisting of Psalms, Job, Daniel, Ezra-Nehemiah, Chronicles, and five short books (Song, Ruth, Lam., Eccl., Esther).

59. II Macc. 14:46.

60. II Macc. 7:14; comp. 6:26; 14:46.

61. II Macc. 7:36.

ment, the dead were supposed to be in some measure still capable of profiting by the intercession of the living. This much is certainly expressed in the famous passage, 2 Macc. xii. 43-45, though the secondary notion of a purgatorial state is in no way implied in it. On the other hand it is not very clear how far the future judgment was supposed to extend. If the punishment of the wicked heathen in another life had formed a definite article of belief, it might have been expected to be put forward more prominently,⁶² though the passages in question may be understood of sufferings after death, and not only of earthly sufferings; but for the apostate Jews there was a certain judgment in reserve.⁶³ The firm faith in the righteous providence of God shown in the chastening of his people, as contrasted with his neglect of other nations, is another proof of the widening view of the spiritual world which is characteristic of the epoch.⁶⁴ The lessons of the captivity were reduced to moral teaching; and in the same way the doctrine of the ministry of angels assumed an importance which is without parallel except in patriarchal times. It was perhaps from this cause also that the Messianic hope was limited in its range. The vivid perception of spiritual truths hindered the spread of a hope which had been cherished in a material form; and a pause, as it were, was made, in which men gained new points of sight from which to contemplate the old promises.

The various glimpses of national life which can be gained during the period, show on the whole a steady adherence to the Mosiac law. Probably the law was never more rigorously fulfilled. The importance of the Antiochian persecution in fixing the Canon of the Old Testament deserves notice. The books of the law were specially

62. II Macc. 7:17, 19, 35, etc.

63. II Macc. 6:26.

64. II Macc. 4:16, 17; 5:17-20, 6:12-16; etc.

sought out for destruction;⁶⁵ and their distinctive value was in consequence proportionately increased. To use the words of 1 Macc. "the holy books in our hands" were felt to make all other comfort superfluous.⁶⁶ The strict observance of the Sabbath⁶⁷ and of the Sabbatical year,⁶⁸ the law of the Nazarites,⁶⁹ and the exemptions from military service,⁷⁰ the solemn prayer and fasting,⁷¹ carry us back to early times. The provision for the maimed, the aged, and the bereaved,⁷² was in the spirit of the law; and the new feast of the dedication was a homage to the old rites,⁷³ while it was a proof of independent life.

The interruption of the succession to the high-priesthood was the most important innovation which was made, and one which prepared the way for the dissolution of the state. After various arbitrary changes, the office was left vacant for seven years upon the death of Alcimus. The last descendant of Jozadak (Onias), in whose family it had been for nearly four centuries, fled to Egypt and established a schismatic worship; and at last, when the support of the Jews became important, the Maccabæan leader, Jonathan, of the family of Joarib, was elected to the dignity by the nomination of the Syrian king,⁷⁴ whose will was confirmed, as it appears, by the voice of the people.⁷⁵

23. *Literature and arts during the Maccabean revolt.*

Little can be said of the condition of literature and the arts which has not been already anticipated. In common

65. I Macc. 1:56, 57; 3:48.

66. I Macc. 12:9.

67. I Macc. 2:32; II Macc. 6:11; 8:26.

68. I Macc. 6:53.

69. I Macc. 3:49.

70. I Macc. 3:56.

71. I Macc. 3:47; II Macc. 10:25.

72. II Macc. 8:28, 30.

73. II Macc. 1:9.

74. I Macc. 10:20.

75. I Macc. 14:35.

THE MACCABEAN PERIOD

intercourse the Jews used the Aramaic dialect which was established after the return: this was "their own language;"⁷⁶ but it is evident from the narrative quoted that they understood Greek which must have spread widely through the influence of Syrian officers. There is not however the slightest evidence that Greek was employed in Palestinian literature till a much later date. The description of the monument which was erected by Simon at Modin in memory of his family⁷⁷ is the only record of the architecture of the time. From the description of this monument it is evident that the characteristics of this work—and probably of later Jewish architecture generally—bore closer affinity to the styles of Asia Minor and Greece than of Egypt or the East; a result which would follow equally from the Syrian dominion and the commerce which Simon opened by the Mediterranean.⁷⁸

The only recognized relics of the time are the coins which bear the name of "Simon," or "Simon Prince (*Nasi*) of Israel," in Samaritan letters. The privilege of a national coinage was granted to Simon by Antiochus VII. Sidetes;⁷⁹ and numerous examples occur which have the dates of the first, second, third, and fourth years of the liberation of Jerusalem (Israel, Zion); and it is a remarkable confirmation of their genuineness that in the first year the name Zion does not occur as the citadel was not recovered till the second year of Simon's supremacy, while after the second year Zion alone is found. The privilege was first definitely accorded in 140 B.C., while the first year of Simon was 143 B.C.;⁸⁰ but this discrepancy causes little difficulty as it is not unlikely that the concession of Antiochus was made in favor of a practice already existing.

76. II Macc. 7:8, 21, 27; 12:37.

77. I Macc. 13:27-30.

78. I Macc. 14:5.

79. I Macc. 15:6.

80. I Macc. 13:42.

No date is given later than the fourth year, but coins of Simon occur without a date which may belong to the last four years of his life. The emblems which the coins bear have generally a connection with Jewish history—a vine-leaf, a cluster of grapes, a vase (of manna?), a three-branched flowering rod, a palm-branch surrounded by a wreath of laurel, a lyre, a bundle of branches symbolic of the feast of tabernacles. The coins issued in the last war of independence by Barocochba repeat many of these emblems, and there is considerable difficulty in distinguishing the two series.

A student of this period of the history of the Jews can not but feel how difficult it is to comprehend it as a whole. Indeed, it seems that the instinct was true which named it from one chief hero. In this last stage of the history of Israel, as in the first, all life came from the leader; and it is the greatest glory of the Maccabees that, while at first they found that everything depended upon their personal fortunes, they left a nation strong enough to preserve an independent faith till the typical kingdom gave place to a universal Church.

SUCCESSIVE MACCABEAN RULERS

24. *The Maccabeans at a glance.*

1. Mattathias (168-167 B.C.)
2. Judas (son of Mattathias) (167-161)
3. Jonathan (brother of Judas) (161-143)
4. Simon (brother of Jonathan) (143-135)
5. John Hyrcanus (son of Simon) (135-106)
6. Aristobulus I (son of Hyrcanus) (106-105)
7. Alexander Jannaeus (brother of Aristobulus I) (105-78)

THE MACCABEAN PERIOD

8. Alexandra (widow of A. Jannaeus) (78-69)
(Hyrcanus II, son of A. Jannaeus and Alexandra, briefly in power in 69).
9. Aristobulus II (Son of A. Jannaeus and Alexandra) (69-63)
10. Hyrcanus II (son of A. Jannaeus and Alexandra) (63-40)
11. Antigonus (son of Aristobulus II) (40-37)

THE ASMONEAN (Maccabean) Family

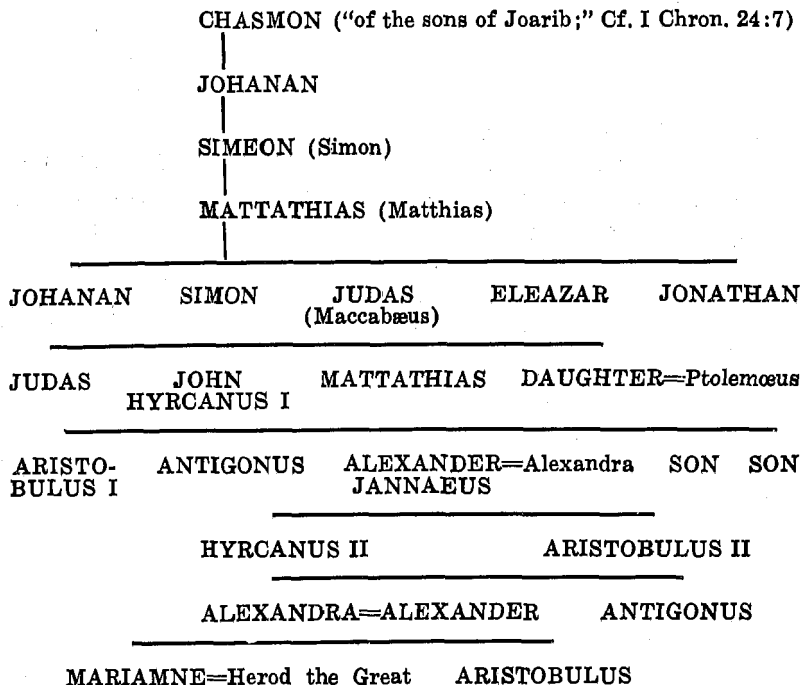

SECTION III

THE ASMONEAN (MACCABEAN) KINGDOM (106-37 B.C.)

1. Change for worse in Jewish history. Aristobulus I becomes King. 2. Aristobulus captures Iturea. Horrible deaths of Antigonus and Aristobulus. 3. Alexander Jannaeus becomes King; his Kingdom invaded. 4. Conquests by the defeats of Alexander Jannaeus. 5. Queen Alexandra plots resistance against the Pharisees. 6. Alexandra dies, and Aristobulus II becomes king and priest. 7. Rise of Antipater the Idumean. Aristobulus besieged in the temple. 8. ROME intervenes in Asia; SYRIA conquered. 9. Two Judean factions appeal for Roman backing. 10. Aristobulus resists Romans but is captured; Pompey takes Jerusalem. 11. Hyrcanus II restored to power; the five Sanhedrins. 12. Escape and defeat of Aristobulus and Antigonus. 13. Crassus plunders the temple. 14. Antipater made procurator of Judea. 15. Family of Antipater; early boldness of Herod. 16. Death of J. Caesar; Cassius' oppression of Judea. 17. Herod and Phasael triumph; they receive the government of Palestine. 18. Parthian invasion of Judea. Death of Phasael; Mutilation of Hyrcanus. 19. Antigonus last ruler of Asmonean Kingdom. Herod made King of Judea. 20. Herod's war with Antigonus; capture of Jerusalem; end of Asmonean dynasty.

WATCH FOR ANSWERS TO THESE QUESTIONS:

1. Did the Asmonean (Maccabean) kingdom develop for the better or the worse?
2. What caused the death of Aristobulus, son of John Hyrcanus?
3. Was Alexander Jannaeus liked by the Jews?
4. Who succeeded Alexander Jannaeus as civil ruler?
5. Who took over the government and priesthood after the death of Queen Alexandra?
6. What nationality was Antipater?
7. Who was Antipater's son?
8. What foreign empire took over Syria in the days of Aristobulus II?

THE ASMONEAN KINGDOM

9. What Roman general entered and conquered Jerusalem? Date?
10. To what country did the Romans annex Judea?
11. Whom did the Romans restore to nominal power over Judea?
12. What did the Syrian Crassus do to the Jerusalem temple?
13. Who appointed Antipater ruler over Judea?
14. What Judean princess did Herod marry?
15. Who gave the government of Palestine to Herod?
16. What people temporarily drove Herod from Judea to Rome?
17. What was the name of Herod's fortress on the west side of the Dead Sea?
18. Who was the last Asmonean ruler?
19. Who appointed Herod as King of Judea?
20. What was the date of Herod's capture of Jerusalem?

1. *Change for worse in Jewish history.*

Aristobulus I becomes king.

No successive pages of history present a more painful contrast than those recording the liberation of Judæa by the Maccabees and its misgovernment by the posterity. In the prosperous reign of John Hyrcanus, we see the seeds of that unholy ambition and religious discord which broke out immediately upon his death. Hyrcanus had left the civil government by will to his wife—an example, among many soon to be met with, of the rise of those female influences which have always played an important part in eastern despotisms—but it was seized, with the high-priesthood, by his eldest son Aristobulus who imprisoned his mother and starved her to death. ARISTOBULUS I. (106-

105 B.C.) assumed the diadem¹ and the title of king and founded the Asmonæan monarchy which lasted just 70 years; but the whole period was one of internal dissension, and for nearly its latter half the interference of the Romans made the royalty little more than nominal.

2. *Aristobulus captures Iturea. Horrible deaths of Antigonus and Aristobulus.*

The brief reign of Aristobulus is marked by one important conquest and a series of domestic tragedies. He subdued Ituræa (afterward called Auranitis), a district east of Jordan at the foot of the Anti-Lebanon mountains; and the inhabitants submitted to circumcision under the threat of banishment. A dangerous illness compelled him to return, leaving behind his favorite brother Antigonus, his other three brothers having been shut up in prison. Antigonus soon completed the conquest and came back to Jerusalem. His appearance in arms to pay his devotions in the Temple was used by the queen Alexandra and the women of the court to rouse Aristobulus' jealousy. Aristobulus summoned him to come unarmed into his presence, and stationed soldiers in the subterranean passage from the Temple to the tower of Baris (later called Antonia) with orders to dispatch him if he appeared in arms. Antigonus was drawn into the trap by treacherous messengers who told him that the king wished to see his splendid armor. The king repented immediately of this slaughter of his brother, and being horror-struck at the crime, vom-

1. This word *diadem* is now used in a vague poetical sense, but it once had a specific meaning among the nations of antiquity. The diadem was a fillet of silk, two inches broad, bound round the head and tied behind, the invention of which is attributed to Liber. Its color was generally white; sometimes, however, it was of blue, like that of Darius; and is sown with pearls or other gems, and enriched with gold (Rev. 9:7). It was peculiarly the mark of Oriental sovereigns (1 Macc. xiii. 82), and hence the deep offense caused by the attempt of Cæsar to substitute it for the laurel crown appropriated to Roman emperors.

ited blood; the slave who bore away the basin slipped upon the spot where Antigonus had been killed, and the blood of the two brothers was thus mingled upon the pavement—too true an emblem of the later history of the Asmonæans. The king compelled his attendants to tell him the cause of the consternation that he saw around him, and, on hearing it, expired in an agony of remorse.² He was doubly obnoxious as a Sadducee, and for his leaning to the Greek party, whence he obtained the epithet of "Greek-lover"; and it is possible that his character has been darkened by party hatred. His three brothers were released from prison after his death.

3. *Alexander Jannæus becomes king. His kingdom invaded. His victories.*

ALEXANDER JANNAEUS (105-78 B.C.), the eldest surviving brother of Aristobulus I., secured the succession of the throne and priesthood by putting his next brother to death on a charge of aspiring to the diadem. The internal commotions both of Syria and Egypt invited him to conquer the cities of Palestine which had not yet submitted: Ptolemais, Gaza, Dora, and the tower of Straton. On his besieging Ptolemais, the people asked aid from Ptolemy Lathyrus, who was now King of Cyprus, having been driven from the throne of Egypt by his mother, Cleopatra. The large force with which Ptolemy came to their relief excited the fears of the citizens and they refused to admit him. He marched into Judæa, defeated Alexander's army with great slaughter, and ravaged the country with horrible cruelties. Judæa was rescued by an army which Cleopatra sent to its aid under two Alexandrian Jews, Chelchias

2. Josephus Ant. XIII, 12.

and Ananias;³ and the queen resisting the advice of her counselors to seize the country was content with the capture of Ptolemais. When the foreign armies had retired, Alexander took Gadara east of Jordan but was defeated before Amathus. He next laid siege of Gaza and after a desperate struggle took and utterly destroyed the city.

4. *Conquests by and defeats of Alexander Jannaeus.
He is honored at his death.*

Meanwhile the Jewish factions were tending rapidly to civil war. The Pharisees incited a tumult against Alexander. As he was officiating at the Feast of Tabernacles, the people pelted him with citrons and revived the insults upon his father's birth. Alexander called in his guards and 6000 of the people were killed. To prevent the recurrence of such tumults, the court of the priests was railed off from the outer court of the temple, and Alexander enrolled a bodyguard of Pisidian and Cilician mercenaries. He then resumed his projects of conquest and subdued Gilead and Moab. Three years later he had advanced against Gaulonitis, a district in the north of Batanea, when he was defeated with the total loss of his army by the Arabian king, Orodes.

The whole Jewish nation now rose in rebellion and a civil war ensued for six years. Alexander's mercenaries at first gave him the upper hand; but, when he asked the people on what terms they would submit, they called out to him to cut his throat. At length, by the aid of Demetrius Eucærus, one of the rival kings of Syria, Alexander was defeated, and his mercenaries cut to pieces, he himself flying to the mountains. By an unexplained reaction of public feeling, he soon recovered all he had lost; and, having

3. The influence acquired by the Jews in Egypt is further proved by the circumstance that Ananias succeeded in dissuading Cleopatra from seizing Alexander when he came to offer his congratulations at Ptolemais.

finished the civil war by the capture of Bethsura, he brought his prisoners in triumph to Jerusalem. Then was seen the incredible spectacle of a high-priest, the great-grandson of Simon the Maccabee, sitting at a banquet with his wives and concubines to gloat his eyes upon the crucifixion of 800 of his enemies and the massacre of their wives and children. The nickname of "Thracian" expressed the impotence of public indignation; his opponents fled the country to the number of 8000; and the remainder of his reign was undisturbed by the open revolt.

It may have been at this time that a number of devout priests withdrew to the lonely Essene colony at Qumran on the N.W. corner of the Dead Sea (where the Dead Sea Scrolls were found). See the section on the Essenes in this book.

Alexander spent some years in extending his dominions to the east of Jordan and defending them against the Syrians and Arabians. He died of a fever at the siege of Ragaba after advising his wife to convene the leaders of the Pharisees, and, having placed his dead body at their disposal, to offer to govern by their counsels. This last propitiation of his inveterate enemies was entirely successful. Alexander's remains were honored with a splendid funeral; his widow Alexandra succeeded to the civil government and his eldest son, Hyrcanus, to the high-priesthood.

5. *Queen Alexandra plots resistance against the Pharisees.*

ALEXANDRA (78-69 B.C.) gave up all real power to the Pharisees who recalled the exiles of their own party and demanded justice on those who had advised the crucifixion of the 800 rebels. But a strong opposition was organized under Aristobulus, the younger son of Alexander, secretly favored by his mother. She sent the ac-

cused persons to garrison some of the frontier towns, and dispatched Aristobulus on a secret expedition against Damascus in which his success gained him the favor of the army.

6. *Alexandra dies. Aristobulus II deposes Hyrcanus II, and becomes king and priest.*

The result was seen when Alexandra, dying at the age of 73, was succeeded nominally by HYRCANUS II. who already held the high-priesthood (69 B.C.). Aristobulus fled from Jerusalem before his mother breathed her last; and collecting an army from the garrison he defeated the forces of the Pharisees at Jericho and advanced upon Jerusalem. Hyrcanus took refuge in the tower of Baris which he surrendered after a short siege, yielding the civil and pontifical crowns to his brother who permitted him to retire into private life.

7. *Rise of Antipater the Idumean. Aristobulus besieged in the temple.*

ARISTOBULUS II. (69-63 B.C.) had scarcely achieved his victory over the Pharisees when a new enemy arose in the person of ANTIPATER whose son Herod was destined to raise a new throne on the ruins of the Asmonæan dynasty. Antipater was by birth an Idumæan (or Edomite) noble, the son of Antipas who had been governor of Idumæa under Alexander Jannæus. Brought up at the royal court, he embraced Judaism, at least in name, and became the bosom friend of Hyrcanus whose feeble mind he now easily bent to his own ambitious schemes. Persuading him that his life was in danger from his brother, Antipater induced Hyrcanus to fly to ARETAS, king of the Nabatæans of Arabia Petræa, a new power which had been growing up around the rock-hewn city of Petra. They soon re-

THE ASMONEAN KINGDOM

turned with an army of 50,000 men under Aretas who defeated Aristobulus and besieged him in the Temple, his late refuge. The passover came round, and the besieged had no lambs to offer. We have seen a Syrian king, Antiochus Sidetes, furnishing victims during a former siege; but the allies, though partisans of a high-priest, mocked the besieged by promising to supply them if they would let down baskets over the wall with the price of the victims, and then, taking the money, they left the baskets to be drawn up empty or placed in them swine instead of the lambs.

Another striking incident of the siege relieves the monotonous story of these civil discords. Onias, an aged man in the camp of Hyrcanus, was required to offer his prayers which had proved effectual during a great drought; and he besought God since His people were on one side and His priests on the other not to hear the prayers of either for each other's hurt. For this impartial patriotism he was stoned to death.

8. *Rome intervenes in Asia; Syria conquered by Rome.*

Amid such scenes it was time for the appearance of that stern arbiter—the Iron state of Nebuchadnezzar's vision (Daniel 2:33, 40)—to which Providence had assigned the work of crushing the effete despotisms of Asia and reducing the civilized world under one government in preparation for the coming of the Christ. ROME, though never wanting a pretext for interference with other states, might plead her alliance of a century before with the Asmonæan princes as making her intervention a duty. Her supremacy in Western Asia had long been disputed and imperiled by Mithridates, whose son-in-law, Tigranes, king of Armenia, had seized Syria in 83 B.C. and remained master of the country till Lucullus defeated Tigranes and restored

the last of the Seleucidæ, Antiochus XIII, in the first year of Aristobulus, 69 B.C. Three years later the conduct of the Mithridatic war was committed to the famous Pompey; and while he defeated Mithridates and plunged in pursuit of him into the regions south of Mount Caucasus, his lieutenant Scaurus was sent to take possession of Damascus and settle the affairs of Syria. After deposing Antiochus XIII. and conquering Syria for Rome (65 B.C.), Scaurus received at Damascus the envoys of Hyrcanus and Aristobulus, who now occupied the positions in which we left them at Jerusalem. Both offered the large bribes of 400 talents, and Scaurus decided in favor of Aristobulus, who was master of the treasures in the Temple (64 B.C.).

9. *Two Judean factions appeal for Roman backing.*

Aretas retired at the Roman's command; and Aristobulus, falling on his rear, gave him a signal defeat. The same year, Pompey himself, having reduced Cœlesyria, appeared at Damascus to receive the homage and presents of the neighboring kings. Aristobulus sent him a golden vine worth 500 talents; but Pompey took care to hold the balance in suspense between the prince who had possession of Jerusalem and his feeble rival. He returned to Syria and came again in the following spring to Damascus to hold a formal court for deciding, not only between the two brothers but between them and the Jewish people who now ventured to complain of the hierarchical kingdom as a usurpation. Hyrcanus was represented by the wily Antipater who had taken care to enforce his argument from the right of the elder brother by bribing more than a thousand of the most distinguished Jews to appear before the tribunal as his adherents. In contrast with his venerable band, there appeared on the part of Aristobulus "a troop of insolent youths, splendidly arrayed in purple, with flowing hair and rich armor who carried themselves as if

they were the true nobles of the land." (Milman). The orators of his party pleaded that the imbecility of Hyrcanus rendered him unfit to govern. The Roman behaved to both with that cold and ambiguous reserve which Cicero has drawn as a leading trait of his character, and while studiously courteous to Aristobulus, he left reason to suspect that his decision would be in favor of Hyrcanus whose incapacity was sure to give a pretext for converting protection into conquest.

10. *Aristobulus resists Romans, but is captured.
Jerusalem is taken and its walls demolished.*

From the fear that the Romans would favor Hyrcanus, or from the consciousness of a bad cause, Aristobulus no sooner saw the departure of Pompey on an expedition to secure the rock-hewn city of Petra, the great trading capital of the Arabs, than he began to prepare for resistance. The rapid return of Pompey disconcerted his plans; and Aristobulus, unable to disobey the mandate to come forth from the stronghold of Alexandrion, was compelled to sign orders for the surrender of all his fortresses. The restless prince still tried the last resource of fleeing to Jerusalem and attempting to defend the city. The Roman legions advanced along the high-road from the East through Jericho where Pompey's admiration was excited by the palmgroves that gave name to the city and the odoriferous shrubs which yielded its far-famed balsams. Once more Aristobulus came forward to offer the surrender of Jerusalem; and he was detained while Pompey sent forward his legate, Gabinius, to take possession of the city. On its unexpected resistance, Pompey threw Aristobulus into chains and advanced with his whole army. He was admitted by the party of Hyrcanus who had now gained the upper hand. The friends of Aristobulus shut themselves up in the Temple, which held out for three months, and was at

last taken by assault with the slaughter of 12,000 Jews. The priests who were engaged about the daily sacrifice calmly continued their service, and many of them were slain at the altar. The Temple was profaned by the entrance of the Roman general, the images on whose standards had long been indicated by Daniel's prophecy of "the abomination that maketh desolate" (63 B.C.); but, as on former occasions, a long respite filled with golden opportunities followed the first step of the threatened judgment before the desolation was completed. Pompey entered the Holy of Holies, where he was amazed to find no statue or other symbol of the Deity. He left the sacred vessels and the vast treasures untouched,⁴ and ordered the Temple to be purified. He conferred the high-priesthood and principality upon Hyrcanus, limiting his territory to Judæa proper, and forbidding him to assume the crown. He imposed a tribute, and demolished the walls of Jerusalem. Aristobulus was carried off, with his two sons and two daughters, to grace the victor's triumph; but Alexander, the elder son, escaped on the way; and Antigonus, the younger, as well as Aristobulus himself, made their escape from Rome at a later period. Meanwhile, the Jews regarded Pompey's sacrilege as the fatal turning-point of his history; and when the civil war broke out, they warmly embraced the party of Cæsar.

11. *Hyrcanus II nominally restored to power. Central government in Judea broken up into five Sanbedrins.*

HYRCANUS II. (63-40 B.C.) was restored to power which was merely nominal; for Judæa was really governed by Antipater in complete subservience to the policy of

4. It excites natural surprise to find the Temple, at this stage of Jewish history, still in possession of treasures which have been computed at two millions sterling. The explanation is to be found in the offerings sent by the pious Jews from every province of the Roman empire.

Rome. In fact, Judæa seems to have been annexed by Pompey to the newly-formed province of Syria, though under a separate administration, both judicial and financial. The progress of Alexander, who soon appeared at the head of 10,000 foot and 1500 horses, left Hyrcanus no choice but Roman protection. Gabinius, the proconsul of Syria, besieged Alexander in the fortress of Alexandrion; but the interest of Alexander's mother with the Romans obtained her son an amnesty on condition of his surrendering that and his other fortresses. The celebrated MARK ANTONY acted in this campaign as the lieutenant of Gabinius. The intervention of Gabinius led to a new settlement of the civil government. He deprived the high-priest of the supreme power which he divided among five "Great Sanhedrins," seated at Jerusalem, Jericho, Gadara, Amanthus, and Sepphoris, and modeled on the Great Sanhedrin of 71 members, which had administered justice at Jerusalem from the time of the Maccabees. Thus the desire of the Jews for emancipation from the temporal power of the high-priest was gratified at the expense of the loss of a central seat of government. This state of things lasted till the restoration of Hyrcanus to the principality by Julius Cæsar, 44 B.C.

12. *Escape and defeat of Aristobulus and Antigonus.* *Defeat of Alexander.*

The new settlement was but just made when Aristobulus, having escaped from Rome with his youngest son Antigonus, gathered a new army and again occupied Alexandrion; but they were speedily defeated by Gabinius and sent back to Rome where Aristobulus remained a prisoner, but Antigonus was again released through his mother's intercession. When Gabinius marched with Mark Antony into Egypt, Alexander seized the opportunity for another revolt and shut up the small Roman force, who had been

left behind, in Mount Gerizim (56 B.C.). At the head of 80,000 men he met Gabinius after his return from Egypt, but was utterly defeated near Mount Tabor, and only saved his life by flight.

13. *Crassus plunders the temple.*

In 55 B.C. CRASSUS received Syria as his share in the partition of provinces by the first Roman triumvirs. In the following year he reached Jerusalem on his disastrous expedition against the Parthians who had complete power beyond the Euphrates and had begun to threaten Syria. The high-priest only whetted his insatiable avarice by the surrender of a secret treasure; and Crassus pillaged the temple of all the wealth which was collected by the annual offerings of the faithful who were dispersed over the world, and which Pompey had spared. His plunder is said to have reached the enormous amount of 10,000 talents, or more than two millions sterling; and his fatal overthrow by the Parthians was viewed by the Jews as the punishment of one more of their oppressors, for Gabinius had already been driven into exile.

14. *Antipater made procurator of Judea.*

On the outbreak of the great Civil War of Rome, Julius Cæsar freed Aristobulus and sent him to Judæa, but he was murdered on the journey by the partisans of Pompey, and his son Alexander was executed by Scipio at Antioch. Antigonus alone was left; and his claims were superseded by the timely aid which Antipater gave Cæsar in his Egyptian campaign (48 B.C.). His services were rewarded by the restoration of his puppet Hyrcanus to the sovereignty, with the title of Ethnarch, and by the remission of tribute in the Sabbatic year. ANTIPATER was made the Procurator of all Judæa, and a Roman citizen; and the aggrandize-

ment of his family occupies the few remaining years of the Asmonæan dynasty.

15. *Family of Antipater. Early boldness of his son Herod.*

Antipater had four sons:—Phasael, Herod, Joseph, and Pheroras, and a daughter named Salome. He made Phasael governor of Jerusalem, and Herod, who was only fifteen years old, governor of Galilee. HEROD soon distinguished himself alike by energy in his government and defiance of all Jewish laws and powers. He put down the banditti by a severity in which we see the germs of his later cruelties. His execution of their leader roused the jealousy of the Sanhedrin, who cited him to answer before them for his assumption of the power of life and death. Confident in the popularity his success had earned, and bearing a menacing letter from Sextus Cæsar, the governor of Syria, Herod appeared before the Sanhedrin in arms and royal purple. The only man who dared to rebuke his presumption and to warn the court against submission, Sameas, was one of the only two whose lives Herod spared when the warning was fulfilled. Hyrcanus adjourned the trial, and permitted Herod to escape to Damascus to Sextus Cæsar, who made him governor of Cœlesyria. It required all the influence of Antipater to dissuade his son from marching in arms upon Jerusalem.

16. *Death of Julius Cæsar. Cassius' oppression of Judea.*

The death of Julius Cæsar (44 B.C.) was a great blow, not only to the party of Hyrcanus and the family of Antipater, but to the whole Jewish nation to whom he had granted protection in their religion. Cassius assumed the government of Syria with the intolerant rapacity of a pro-

consul of the old school. Judæa was assessed at 700 talents, half to be raised by Antipater and his sons, and half by Malichus, a courtier of Hyrcanus. Malichus being unable to raise his portion would have fallen a victim to the resentment of Cassius⁵ had not Antipater made good the deficiency from the treasures of Hyrcanus. Malichus repaid the obligation by poisoning Antipater; but Herod not long afterward procured the murder of Malichus in the presence of Hyrcanus who was forced to approve the deed as performed by the authority of Cassius whose favor Herod had completely won.

17. *Herod and Phasaël triumph. They receive the government of Palestine.*

The departure of Cassius from Syria seemed to give the stricter Jews the opportunity of throwing off the domination of the Herodians, for so we may call the party since the death of Antipater. But Phasaël put them down at Jerusalem, and Antigonus himself was repulsed from Galilee by Herod. Their hopes revived with the battle of Philippi (42 B.C.); and Hyrcanus placed himself at their head. He was won back, however, by Herod who offered to marry his granddaughter Mariamne⁶ and so allied himself to the Asmonæan family. Herod also defeated Antigonus, though supported by the Roman governor of Damascus; and his presents and flattery secured the favor of Mark Antony to whom the second triumvirate had given the dominion of the East. Antony committed the two governments of Palestine to Herod and his brother Phasaël, under the title

5. This great "liberator" of his country sold the people of several defaulting villages into slavery.

6. She was the daughter of Alexander, the son of Aristobulus, and of Alexandra, the daughter of Hyrcanus, and so the last representative (except Antigonus and her brother Aristobulus) of both the surviving branches of the Asmonæan house. By the marriage, which took place in B.C. 37, the same year in which Antigonus was put to death, Herod adopted her claims as his own.

of tetrarchs, and issued various decrees in favor of Hyrcanus and the Jewish nation (41 B.C.).

18. *Parthian invasion of Judea. Death of Phasaël.
Mutilation of Hyrcanus.*

A last ray of hope from the East gilded the fall of the Asmonæans. While Antony was spending his time in dalliance with Cleopatra, Syria revolted and called in the aid of the Parthians under Pacorus the king's son (40 B.C.). Antigonus, the surviving son of Aristobulus, offered the Parthian general 1000 talents and 500 women of the noblest families if he would restore him to the throne. Supported by a Parthian force, Antigonus marched upon Jerusalem, where the two factions came to open war, and Hyrcanus was only upheld by Herod's energy and severity. At length Hyrcanus and Phasaël were induced, against the advice of Herod, to submit their cause in person to Barzaphernes, the Parthian commander in Syria. Herod fled to Masada, a strong fortress on the west side of the Dead Sea, where he placed his mother, his sister, and his betrothed bride, Mariamne, under the care of his brother Joseph and an Idumæan force, while he betook himself to Rome. Foiled in the main object of securing Herod's person, the Parthian general threw Hyrcanus and Phasaël into chains. The latter committed suicide in prison. The former was mutilated of his ears, in order to disqualify him from continuing high-priest. He lived for some years longer, and was at last put to death by Herod on a charge of treason.

19. *Antigonus, last ruler of the Asmonean kingdom.
Herod made king of Judea.*

ANTIGONUS, the last ruler of the Asmonæan house, held a nominal sovereignty for three years (40-37 B.C.). The Parthians ravaged the country, and Herod soon re-

turned in a new character. He had artfully advocated with the triumvirs the claims of young Aristobulus, the brother of Mariamne, who was the grandson both of Aristobulus and Hyrcanus.⁷ But his real wishes were doubtless well known to his former friend Anthony; with his usual address he secured the favor of Octavian; and the result was a decree of the Senate appointing him king of Judæa.

20. *Herod's war with Antigonus. His capture of Jerusalem. End of the Asmonean dynasty.*

All this was done at Rome in the short space of a week, and Herod landed at Ptolemais after an absence of only three months. Antigonus was now left to himself, his Parthian allies having retired on the advance of Ventidius, the legate of Antony. He was besieging Masada, which Herod speedily relieved with the aid of a Roman force under Silo. The treachery of this general, whose object was to make all the gain he could of both parties, compelled Herod, after considerable successes, to retire from before Jerusalem. Fixing his head-quarters in Samaria, he employed his energies in clearing Galilee of robbers. The next year's campaign was indecisive; but, after the expulsion of the Parthians from Syria, Antony placed a sufficient force at Herod's disposal. Having gained a great battle over Pappus, the general of Antigonus, Herod formed the siege of Jerusalem in the spring of 37 B.C.; while he sought to recommend himself to the Asmonæan party by completing his marriage with Mariamne. The siege lasted six months; the sufferings of the besieged being increased by the scarcity of a Sabbatic year. The city was at length taken on a Sabbath; and such was the fury of the Roman soldiery under Sosius, that Herod had to entreat that he might not be left king of a depopulated capital. Antigonus

7. His father was Alexander, the elder son of Aristobulus, and his mother was Alexandra, the daughter of Hyrcanus.

THE ASMONEAN KINGDOM

was sent in chains to Antony, who put him to death at Herod's instigation. The last king of the Maccabæan line was the first sovereign who ended his life beneath the rods and axe of the Roman lictor; and the Jewish historian so far sympathizes with Rome, as to forget the shame of his nation in contempt for the weakness of its last native ruler. Thus ended the Asmonæan dynasty (37 B.C.), in the 130th year from the first victories of Judas Maccabæus, and the 70th from the assumption of the royal title by Aristobulus I. We shall soon see how the sole remaining scion of the long line of heroes, priests, and princes, the young Aristobulus, was cut off by Herod.

SECTION IV

HEROD THE GREAT (37-4 B.C.)

1. Herodian family seeks to establish great, worldly, independent Kingdom. 2. HEROD the GREAT: His cruelty and total domination of the land. 3. Resistance to Herod. Herod and the high priesthood. Murder of Aristobulus. 4. Herod resists Cleopatra. 5. Herod avoids the battle of Actium, and wins the favor of Octavian. 6. Extent and divisions of Herod's Kingdom. 7. Herod's domestic tragedies—Murders of Mariamne and Alexandra. 8. Government of Herod; his Hellenizing practices; building Antonia, Sebaste, and Cæsarea. 9. Herod courts Augustus and Agrippa; his munificence. 10. Rebuilding the temple.—Special Study; The Temple of Herod. 11. Herod's other buildings in Jerusalem. 12. Family troubles of Herod. Execution of his two sons Aristobulus and Alexander. 13. Herod's golden eagle thrown down. 14. Conspiracy of Herod's son Antipater. 15. Herod's last sickness. Visit of wise-men. Massacre of Bethlehem babes. 16. Execution of Herod's son Antipater. Herod's death. 17. Character of Herod. 18. Herod's relation to sacred history. 19. Jewish history in two streams after the time of Herod. 20. The Herodian party. 21. Roman Emperors of N.T. times.

WATCH FOR ANSWERS TO THESE QUESTIONS:

1. What sort of kingdom did the Herods aspire to establish?

NEW TESTAMENT BACKGROUNDS

2. Was Herod's friendship with Rome a matter of necessity or choice?
3. What office among the Jews did Herod recklessly appoint men to and depose them from?
4. What god did Herod make offerings to when he came to the throne?
5. What did Herod do to the Sanhedrin?
6. How did Herod kill Aristobulus the priest?
7. What foreign queen did Herod successfully resist?
8. How did Herod avoid being involved in the battle of Actium?
9. What were the four main divisions of Palestine during the time of Herod?
10. What was Decapolis?
11. How did Mariamne die?
12. What "entertainments" did Herod provide for the people of Jerusalem to view?
13. What did Herod name the strong tower north of the temple?
14. What did Herod rename Samaria?
15. What new seaport did Herod build?
16. From whom did Caesarea-Philippi get its name?
17. How did the name *Agrippa* get into the Herodian family?
18. How did the Jews feel about Herod's starting out to rebuild the temple?
19. Where else did Herod build a temple besides at Jerusalem?
20. Name the four courts of Herod's temple.
21. Name two of the porches (porticos) of Herod's temple.
22. When was the temple completed? How long was this before its destruction?
23. How many towers did Herod build in N.W. Jerusalem?
24. What happened to Mariamne's sons Aristobulus and Alexander?

HEROD THE GREAT

25. What happened to the rabbis who tore down Herod's golden eagle?
26. Which of Herod's sons plotted against his father?
27. What was Herod's physical condition in his last years?
28. About how many babes died in Herod's massacre at Bethlehem?
29. Why was it better to be Herod's hog than his son?
30. In what ways was Herod great?
31. What were the two streams of Jewish history after the time of Herod?
32. What was the name of the political party which favored the program of Herod?
33. With what group did this party ally itself against Christ?

1. *The Herodian family seeks to establish a great, independent worldly kingdom.*

The history of the Herodian family presents one side of the last development of the Jewish nation. The evils already seen in the priesthood which grew up after the Return, found an unexpected embodiment in the tyranny of a foreign usurper. Religion was adopted as a policy; and the hellenizing designs of Antiochus Epiphanes were carried out, at least in their spirit, by men who professed to observe the Law. Side by side with the spiritual "kingdom of God," proclaimed by John the Baptist, and founded by the Lord, a kingdom of the world was established, which in its external splendor recalled the traditional magnificance of Solomon. The simultaneous realization of the two principles, national and spiritual, which had long variously influenced the Jews in the establishment of a dynasty and a church, is a fact pregnant with instruction. In the fullness of time a descendant of Esau, Herod the Great, established a false counterpart of the promised glories of Messiah.

Various accounts are given of the ancestry of the Herods; but it seems certain that they were of Idumæan descent, a fact which is indicated by the forms of some of the names which were retained in the family. But though aliens by race, the Herods were Jews in faith. The Idumæans had been conquered and brought over to Judaism by John Hyrcanus (130 B.C.); and from the time of their conversion they remained constant to their new religion, looking upon Jerusalem as their mother city, and claiming for themselves the name of Jews.¹

The general policy of the whole Herodian family, though modified by the personal characteristics of the successive rulers, was the same. It centred in the endeavor to found a great and independent kingdom in which the power of Judaism should subserve the consolidation of a state. The protection of Rome was in the first instance a necessity, but the designs of Herod I. and Agrippa I. point to an independent Eastern Empire as their end, and not to a mere subject monarchy. Such a consummation of the Jewish hopes seems to have found some measure of acceptance at first, and hence arose the party of the *Herodians*; and by a natural reaction the temporal dominion of the Herods opened the way to the destruction of the Jewish nationality. The religion which was degraded into the instrument of unscrupulous ambition lost its power to quicken a united people. The high-priests were appointed and deposed by Herod I. and his successors with such a reckless disregard for the character of their office that the office itself was deprived of its sacred dignity. The nation was divided; and amid the conflicts of sects a universal faith arose which more than fulfilled the nobler hopes that found no satisfaction in the treacherous grandeur of a court.

1. Josephus, *Ant.* XX., 7, 7; *Wars*, I, 10, 4.

2. *Herod the Great: His cruelty and total domination of the land. Slaughter of the Sanhedrin.*

HEROD THE GREAT² (37-4 B.C.) was now established on the throne of Judæa and founded a dynasty of princes who ruled in different parts of Palestine under various titles; but among whom he himself was the last, as he was the first, independent sovereign of the whole country. For he may be termed independent in reference to the exercise of his power, though its origin and tenure rested on the will of his Roman masters. By birth an Idumæan, by policy and predilection an adherent and imitator of Rome, he seemed to many of his subjects little better than a heathen conqueror; and his cruelties to the Asmonæan house, which was still held in reverence, roused a deep sense of indignation. He signalized his elevation to the throne by offerings to the Capitoline Jupiter, and surrounded his person with foreign mercenaries, some of whom had been formerly in the service of Cleopatra. His coins, and those of his successors, bore only Greek legends, and he introduced heathen games within the walls of Jerusalem. He resolved at once to show the malcontents that they had a master. Massacre and confiscation were dealt out to the Asmonæan party. Forty-five of the chief adherents of Antigonus were put to death with the whole Sanhedrin, except the rabbis Sameas and Pollio who had counseled the surrender of Jerusalem during the siege. Their spoils enabled Herod to satisfy the rapacity of his patron Antony.

3. *Resistance to Herod. Herod and the high priesthood. Murder of Aristobulus.*

The whole period of Herod's reign was in many respects a repetition of that of the Maccabees and Antiochus

2. Ewald observes that Herod is not called the *Great* in any contemporary document. There are inscriptions which style him "the Great King," but this is a title of royalty, not the appellation of the man.

Epiphanes. True, Herod was more politic and more prudent, and also probably had more sympathy with the Jewish character than Antiochus. But the spirit of stern resistance to innovation and of devotion to the law of Jehovah burned no less fiercely in the breasts of the people than it had done before; and it is curious to remark how every attempt on Herod's part to introduce foreign customs was met by outbreaks, and how futile were all the benefits which he conferred both on the temporal and ecclesiastical welfare of the people when these obnoxious intrusions were in question. Whatever his ultimate designs might be, he was not yet prepared to annul the great institutions of religion; nor, as a stranger of the hated race of Esau, did he venture to assume the robes of Aaron. He brought an obscure priest from Babylon named Ananel to fill the office of high-priest which had been vacant since the mutilation of Hyrcanus. But this insult to the surviving members of the Asmonæan house found an able and unscrupulous opponent. This was Alexandra, the daughter of Hyrcanus, widow of Alexander the elder son of Aristobulus, and mother of Herod's wife Mariamne, and of young Aristobulus, whose claims we have seen Herod himself affecting to support at Rome. Her adroit appeals to Cleopatra, and her unscrupulous intrigues to win over Antony, alarmed Herod, who, always ready to trim his policy by necessity, conferred the high-priesthood on Aristobulus. But the people's applause, when they saw the graceful youth of sixteen, the last scion of the Maccabees, perform his office with a dignity becoming his descent, sealed the doom which had doubtless already been resolved on. At a feast given by Alexandra to Herod near Jericho, Aristobulus was drowned while bathing in a tank, as if accidentally, by the rough play of his comrades, who were instigated by Herod. Ananel was then reappointed to the priesthood. (Josephus, *Wars*, I. XXII, 2)

4. *Herod resists Cleopatra.*

It was in vain that the king honored his victim with a splendid funeral. The people were not deceived by his pretended grief; and Alexandra again appealed to Cleopatra. Herod was summoned to Antony at Laodicea. He resolved to face the danger; but with the desire for a sweet revenge on Alexandra in the death of her remaining child, he left orders with his brother Joseph to dispatch Mariamne on the first news of his own death. Herod's gifts and personal influence with Antony triumphed even over the enmity of Cleopatra; but the visit had fatal consequences. Herod returned with Cœlesyria added to his dominions, to have his mind poisoned against his wife by the jealousy of his sister Salome. His fondness for Mariamne, however, prevailed over suspicion, till her own remonstrance with him for the cruel sentence which Joseph had betrayed to her seemed to prove the familiarity alleged by Salome. But her charms had not yet lost their power, and his rage was satiated by the execution of Joseph and the imprisonment of Alexandra. A new danger followed in the shape of a visit of Cleopatra to Jerusalem on her return with Antony from his Parthian expedition; but Herod, after saving his kingdom from her cupidity, had the rarer skill to preserve himself from her fascinations. He is even said to have contemplated her murder, as the best service he could do at once to Antony and himself, and to have afterward taken credit with Augustus for such a proof of friendship to his patron.

5. *Herod avoids the battle of Actium, and wins the favor of Octavian.*

In the spring of 31, the year of the battle of Actium, Judæa was visited by an earthquake, the effects of which

appear to have been indeed tremendous: 10,000³ or, according to another account,⁴ 20,000 persons were killed by the fall of buildings, and an immense quantity of cattle. The panic at Jerusalem was very severe; but it was calmed by the arguments of Herod, then departing to a campaign on the east of Jordan for the interests of Cleopatra against Malchus king of Arabia. This campaign, in which Herod won a dear-bought victory, kept him, whether by good fortune or design, from following Antony to Actium, where Antony was defeated by Octavian (Augustus Cæsar).

Herod went to meet the conqueror at Rhodes, having first put an end to all rivalry from the Asmonæan house by the execution of the aged Hyrcanus on a charge of treason (30 B.C.). He intrusted the government to his brother Pheroras and provided for the safety of his family in the fortress of Masada. Mariamne and her mother were placed in Alexandrion under the care of his steward Joseph and an Ituræan named Soemus with the same secret instruction as before. Herod had not miscalculated his personal influence over the young Octavian. Instead of apologizing for his faithful adherence to Antony, he urged it as a proof of the constancy which the conqueror might expect. He returned to Judæa, invested anew with the diadem, and honored with marks of personal favor. He shortly after met Octavian on his way to Egypt as Ptolemais, and secured his favor by a magnificent entertainment, by providing for all the wants of the Roman army and by a present of 800 talents.

6. *Extent and divisions of Herod's kingdom.*

When the tragedy of Antony and Cleopatra was consummated and Egypt reduced to a Roman province, Octavian restored to Herod those parts of Palestine which

3. Josephus, *Ant.* XV, 5, 2.

4. Josephus, *Wars*, I, 19, 3.

HEROD THE GREAT

Antony had presented to Cleopatra, as well as the fortresses and maritime towns which had long been the objects of dispute, as Gadara, Samaria, Joppa, Gaza, and the Tower of Straton, soon to become the princely city of Cæsarea. Herod was now master of a kingdom which included all the land originally divided among the twelve tribes, together with Idumæa. Exclusive of the latter country, the whole was divided into four districts, a clear conception of which is needful for understanding the topography of our Lord's ministry:—i. JUDAEA; extending from the confines of Egypt and the southern desert to a line drawn from Joppa, not far different from the 32d parallel of latitude. ii. SAMARIA; whose N. boundary ran along the hills S. of the plain of Esdraelon, meeting the sea S. of Dora. iii. GALILEE, Lower and Upper; extending northward as far as the parallel of Mount Hermon; but shut out from the sea by the narrow strip of Phœnice, which reached S. of Carmel and even of Dora. iv. PERAEA,⁵ the name of the whole region E. of Jordan and the Dead Sea as far S. as the Arnon, which was again subdivided into—(1) *Peraea*, in the narrower sense, between the Arnon and the Jabbok: (2) *Galaaditis*, the old land of Gilead, partly overlapping the former: (3) *Batanaea*, (4) *Gaulonitis*, and (5) *Ituræa* or *Auranitis*, embracing together the ancient country of *Basban*: (6) *Trachonitis*, in the wild rocky desert of the *Hauran*. (7) *Abilene*, among the eastern foot-hills of the Antilibanus, lay beyond the proper limits of the country. Lastly, (8) *Decapolis*, a name at first given to Ten Cities in the north, which were rebuilt and endowed with certain privileges at the time of the first Roman occupation (65 B.C.), became the designation of a large district on both sides the lake of Galilee.

5. *Peraea*, a Greek term meaning *the opposite country*, is a general term in Greek geography for any land on the opposite side of a river, strait, etc., as we say "over the water."

7. *Herod's domestic tragedies—murders of Mariamne and Alexandra.*

This fair kingdom had been won (we have seen in what way) by a man of ability, magnificence, and taste; but utterly regardless of his people's most cherished feelings, and insensible to the high destiny of the "Holy Nation," the "peculiar possession of Jehovah." This idea has been for some time so steadily fading that the sacred name has almost disappeared from our pages; but it was reserved for the Idumæan usurper at once to reunite the nation and to heathenize its government, and so to prove the need, while smoothing the way, for the advent of the Christ. Meanwhile Herod's prosperity was poisoned by unparalleled domestic tragedies. Alexandra and Mariamne had again won from Soemus the secret of Herod's fatal orders, and this time the wife's indignation and the renewed accusations of Salome were too strong for Herod's fondness. Convinced at length that guilty love was the price of his betrayed secret, Herod sentenced Mariamne to death; and her last moments were insulted by the reproaches with which her mother purchased a brief respite for herself. The proud and beautiful queen died with the courage of innocence, leaving Herod the victim of a remorse which never ceased. In its first transports he retired into solitude, and fell dangerously ill. Alexandra now thought the time was come to consummate her intrigues and revenge; but her plot for seizing the Tower of Baris (or Antonia) was betrayed to Herod, and she was led to the fate which her daughter had so lately suffered. Her death removed Herod's last fears from the Asmonæans; but his illness seems to have given the last permanent tinge of morose cruelty to his stern temper. Among many distinguished victims to the charge of an Asmonæan conspiracy was Costabaras, an Idumæan, the former husband of Salome, who had divorced him in direct violation of the law.

8. *Government of Herod. His pro-Grecian practices. Building of tower of Antonia, Sebaste and Caesarea.*

Herod's public administration was directed to the increase of his own royal state, and the gratification of his imperial master. But he probably acted also from the more subtle policy of "counterbalancing by a strong Grecian party the turbulent and exclusive spirit of the Jews." The Jews, who had so nobly resisted the attempt to persecute them into Hellenism, were now invited to adopt both Greek and Roman customs. The holy hill, to which David had carried up the ark of God, looked down upon a theatre and amphitheatre, in which Herod held games in honor of Augustus, with musical and dramatic contests, horse and chariot races, and the bloody fights of gladiators and wild beasts, while Jewish athletes took part in gymnastic contests. The sullen submission of the people was only overtaxed by the sight of the trophies hung round the theatre; but when Herod had them opened to show that they contained no idols; indignation gave way to ridicule. A few, however, viewed these proceedings with far sterner feelings. Ten zealots bound themselves by a vow to kill Herod in the theatre; but they were discovered and put to death, enduring the most cruel torments with the constancy of the Maccabæan martyrs.

At this time Herod occupied the old palace of the Asmonæans which crowned the eastern face of the upper city and stood adjoining the Xystus at the end of the bridge which formed the communication between the south part of the Temple and the upper city.⁶ This palace was not yet so magnificent as he afterward made it, but it was already most richly furnished.⁷ Herod had now also completed the improvements of the Baris—the fortress built by John Hyrcanus on the foundations of Simon Maccabæus

6. Josephus, *Ant.* XV, 8, 5. Comp. XX, 8, 11, and *Wars* II, 16, 3.

7. *Ant.*, XV, 9, 2.

—which he had enlarged and strengthened at great expense, and named *Antonia*—after his friend Mark Antony. This celebrated fortress formed an intimate part of the TEMPLE as reconstructed by Herod. It stood at the west end of the north wall of the Temple and was inaccessible on all sides but that. He provided a refuge, in case of need, from the hostility of Jerusalem, in the two fortresses of Gaba in Galilee and Heshbon in Peræa.

A similar feeling was displayed in his restoration of Samaria, which he called Sebaste,⁸ in honor of Augustus, and peopled with his veteran soldiers mingled with descendants of the old Samaritans. But his greatest undertaking in this sort was the erection of a new seacoast city on the site of the Tower of Straton. An exposed anchorage was converted into a safe harbor by a mole 200 feet wide, constructed of immense stones and fortified with towers. The city, magnificently built in the Græco-Roman style of architecture, rose in the form of an amphitheatre from the quays that lined the harbor. Among its public buildings were a theatre and amphitheatre; and in its centre stood a temple dedicated to Augustus, with two colossal statues, one of Rome, and the other of the Emperor, in whose honor the city was called CAESAREA. That all might be in keeping, it was peopled chiefly by Greeks. Its erection occupied twelve years. Designed probably for Herod's new capital, whenever he might feel it safe to throw off the last shred of Judaism, it became before long the seat of Roman government. Meanwhile its maritime position brought Judæa into closer contact than ever with the Roman world. The ruins of Cæsarea and its harbor on the Mediterranean have been excavated extensively in recent years. (Jack Finegan, *Archæology of the N.T.*, Princeton, 1969, p. 70ff)

8. *Sebastos* was the Greek translation of the Latin *Augustus*, and was used throughout the East as the title of the Emperor.

HEROD THE GREAT

Herod's leaning to the religion of Rome was shown by his erecting a temple of white marble, dedicated to Augustus, at the chief source of the Jordan, which had already acquired the heathen name of *Panium* (the *Cave of Pan*). Around this temple his son Philip afterward built the city of *Caesarea-Philippi*, in honor of Tiberius.

9. *Herod courts Augustus and Agrippa.* *His munificence.*

Herod's sons by Mariamne, Aristobulus and Alexander, were sent to be educated at Rome; and he lost no opportunity of waiting upon Augustus, whether in his wars or his peaceful progresses. At the same time he maintained the closest friendship with the great minister Agrippa, so that "Cæsar was said to assign Herod the next place in his favor to Agrippa; Agrippa to esteem Herod higher than any of his friends, except Augustus." This intimacy was the cause of the introduction into the family of Herod's son Aristobulus of the name of AGRIPPA, which appears in the *Acts of the Apostles*. (Acts 25:13). He courted the people of Greece by magnificent donations to the temple at Olympia, and was made perpetual president of the Olympic games—a strange mutation for both Jews and Greeks, that a half-hearthen king of Judæa should be the recognized head of the Hellenic race.

Herod's subjects were not without some compensation for all these insults to their national traditions. True, he put down every show of opposition with relentless severity. His perpetual fears of the Pharisees and Essenes prompted him to require of them an oath of allegiance, and he knew how to revenge himself for their obstinate refusal. His espionage was always vigilant, and many murmurers disappeared forever in the prison of Hyrcania, which has been called Herod's Bastile. But he displayed a princely liberality. His great works enriched the industrious, without

adding to the burdens of the country; and the taxes were diminished by a third.

The year 25 B.C.—the next after the attempt on Herod's life in the theatre— was one of great misfortunes. A long drought, followed by unproductive seasons, involved Judæa in famine, and its usual consequence, a dreadful pestilence. Herod took a noble and at the same time a most politic course. He sent to Egypt for corn, sacrificing for the purchase the costly decorations of his palace and his silver and gold plate. He was thus able to make regular distributions of corn and clothing on an enormous scale for the present necessities of the people as well as to supply seed for the next year's crop.⁹ The result was to remove to a great degree the animosity occasioned by his proceedings in the previous year.

In this year or the next Herod took another wife, the daughter of an obscure priest of Jerusalem named Simon. Shortly before the marriage Simon was made high-priest in the place of Joshua, or Jesus, the son of Phaneus, who appears to have succeeded Ananel, and was now deposed to make way for Herod's future father-in-law.¹⁰ It was probably on the occasion of this marriage that he built a new and extensive palace immediately adjoining the old wall at the north-west corner of the upper city,¹¹ about the spot now occupied by the Latin convent, in which, as memorials of his connection with Cæsar and Agrippa, a large apartment, superior in size to the sanctuary of the Temple, was named after each. This palace was very strongly fortified; it communicated with the three great towers on the wall erected shortly after, and it became the *citadel*, "special fortress," as Josephus calls it, of the upper city. A road led to it from the northern gate in the west wall of the Temple enclosure.

9. Josephus, *Ant.*, XV, 9, 2.

10. *Ant.* XV, 9, 3.

11. *Wars*, V, 4, 4.

10. *Rebuilding of the temple.*

But his great claim to the favor of the Jews was that restoration of the *Temple*, the design of which he announced to the people assembled at the Passover (20 or 19 B.C.). If we may believe Josephus, he pulled down the whole edifice to its foundations and laid them anew on an enlarged scale. The new edifice was a stately pile of Græco-Roman architecture, built in white marble with gilded *acroteria*. It is minutely described by Josephus, and the New Testament has made us familiar with the pride of the Jews in its magnificence. A different feeling, however, marked the commencement of the work, which met with some opposition from the fear that what Herod had begun he would not be able to finish. He overcame all jealousy by engaging not to pull down any part of the existing buildings till all the materials for the new edifice were collected on its site. Two years appear to have been occupied in these preparations, among which Josephus mentions the teaching some of the priests and Levites to work as masons and carpenters—and then the work began.

The holy "house", including the Porch, Sanctuary, and Holy of Holies, was finished in a year and a half (16 B.C.). Its completion, on the anniversary of Herod's inauguration, was celebrated by lavish sacrifices and a great feast. Yet even this splendid work was not likely to mislead the Jews to the real spirit of the king. While he rebuilt the temple at Jerusalem, he rebuilt also the temple at Samaria, and made provision in his new city of Cæsarea for the celebration of heathen worship; and it has been supposed that the rebuilding of the Temple furnished him with the opportunity of destroying the authentic collection of genealogies which was of the highest importance to the priestly families. Herod, as appears from his public designs, affected the dignity of a second Solomon, but he joined the license of that monarch to his magnificence; and it was

NEW TESTAMENT BACKGROUNDS

said that the monument which he raised over the royal tombs was due to the fear which seized him after a sacrilegious attempt to rob them of secret treasures.

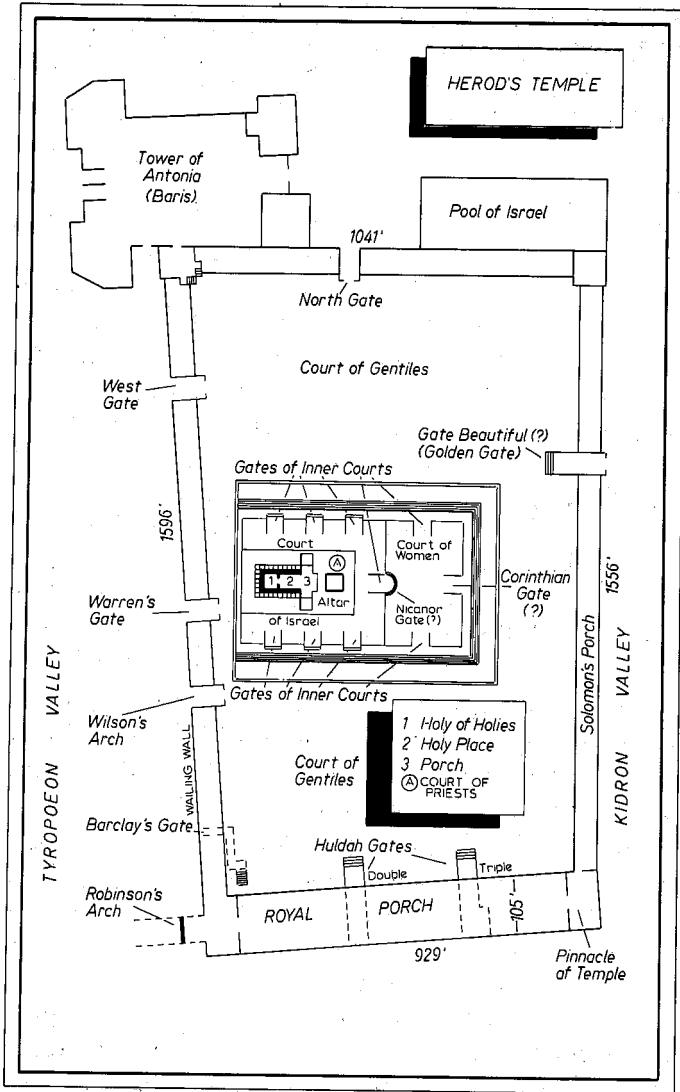

THE TEMPLE OF HEROD

For our knowledge of the last and greatest of the Jewish temples, we are indebted almost entirely to the works of Josephus and the Talmudic tractate *Middoth* (meaning "Measurements").

The temple itself was surrounded by a series of courts. Inside of each larger court were successively smaller courts. The courts were named as follows:

- (1) Court of Gentiles. This was the largest court and was the largest court and was open to everyone.
- (2) Court of the Women. This lay in front of (to the east of) the temple proper, and was open to Jewish women.
- (3) Court of Israel. Only Jewish men might enter this court.
- (4) Court of the priests. Only priests could enter this section.

While Josephus says that the outer court was externally 400 cubits each way, there is no reason to assume that this court in New Testament times was much different in size from the present Haram-es-sheerif, the walled enclosure containing the Dome of the Rock, and eight-sided Mohammedan shrine probably built on the same spot as Solomon's and Herod's temple. This court now is 929 feet on the south side, 1041 feet on the north, 1556 on the east, and 1596 on the west, and its total area is some thirty-five acres. (See Jack Finegan, *Archaeology of the New Testament*, Princeton, 1969, p. 118).

The large court around the temple area had magnificent porches (also called porticoes, cloisters, or stoas) on the inside of the walls. The cloisters in the west, north, and

east sides were composed of double rows of Corinthian columns, 25 cubits or 37 feet 6 inches in height, with flat roofs, and resting against the outer wall of the Temple. These, however, were immeasurably surpassed in magnificence by the royal porch or *Stoa Basilicæ* (or Royal Porch), which overhung the southern wall. It consisted of a nave (or central open area) and two aisles, that toward the Temple being open, that toward the country closed by the wall. The breadth of the centre nave was 45 feet; of the side aisles 30 from centre to centre of the pillars; their height 50 feet, and that of the centre aisle 100 feet. Its total length was one stadium or 600 Greek feet. This magnificent structure was supported by 162 Corinthian columns. The porch on the inside of the east wall was called Solomon's porch (Acts 3:11).

The wall of the outer court had one gate on the north, four on the west, two on the south, and one on the east.

The eastern gate (which Josephus does not mention, but which is mentioned in the Talmud) appears to have been the Gate Beautiful mentioned in Acts 3:10. The location of the Gate Beautiful is uncertain; some say it was the Nicanor Gate leading from the court of the Women into the Court of Israel. The eastern gate of the Court of the Gentiles is presently called the Golden Gate, and is walled up. According to the Talmud this gate (through which Christ entered at his triumphal entry) was decorated with drawings of the Palace of Shushan, where Queen Esther lived. This was to make the people "ever mindful when they came." Some have therefore called this the Shushan Gate. The fact that it opens through Solomon's Porch adds strength to the view that it is the Gate Beautiful of Acts chapter three. (Acts 3:2, 8, 11).

The two southern gates into the temple area are also now walled up. From west to east they are respectively called the Double Gate and the Triple Gate, because they

HEROD THE GREAT

had two and three openings. They seem to be the Huldah gates referred to in the *Middoth*.

At the extreme southwest corner of the temple an entrance opened into the Royal Porch (Stoa Basilica). This entrance was approached by a bridge across the Tyropeon Valley. A small part of one arch of this bridge still remains in the wall; it is known as Robinson's Arch.

There were four gates into the temple area on the west, commonly known by the names of the modern explorers who discovered or wrote about them. From south to north they are Barclay's Gate, Wilson's arch, Warren's Gate, and the West Gate. Wilson's Arch is now deeply underground. (See *Biblical Archaeologist*, Jan. 1966, p. 27ff., and Jan. 1967, p. 27ff.)

The temple enclosure within the Court of the Gentiles was several steps higher than the large court surrounding it. The temple area—referring to the Court of Israel and the temple within it—was approximately 180 by 240 cubits. The elevated area comprising the Temple enclosure and the court of the women was entered by ten gates. Signs at each of these gates warned any Gentiles that they entered only at the risk of the death penalty.

Of these ten gates, nine were overlaid with gold and silver. But one was of Corinthian bronze, and far exceeded in costliness the ones that were plated with silver and set in gold. (See Josephus, *Wars*, V, 5, 2-3.) Whether this was the Nicanor gate leading from the Court of Women into the Court of Israel, or whether it was the gate leading from the Court of Gentiles into the Court of Women, is not completely certain; the latter position seems more probable.

Immediately within the entrance to the court of priests stood the great altar of burnt offerings. Both the Altar and the temple were enclosed by a low parapet one cubit

in height, placed so as to keep the people separate from the priests while the latter were performing their functions.

The temple itself had the same dimensions as Solomon's temple, 60 cubits long, and 20 cubits wide; however it was 60 cubits high. It was divided into the Holy Place (20 by 40 cubits) and the Holy of Holies (20 cubits by 20 cubits). In the Holy Place were kept the seven-branched golden lampstand, the altar of incense, and the table for the showbread. A representation of the lampstand may be seen on the arch of Titus in Rome, where it is pictured as part of the booty taken from Jerusalem when the Romans captured the city in A.D. 70. There was no furniture at all in the Holy of Holies of Herod's temple.

Separating the Holy of Holies from the Holy place was a heavy veil corresponding to the one in the tabernacle of Moses. According to Rabbinical traditions, the veil in Herod's temple was 40 cubits long, 20 wide, had the thickness of the palm of the hand, and was made in 72 squares. This was the heavy veil that was ripped apart from top to bottom at the time of the death of Christ Jesus (Matt. 27:51).

This temple made an overwhelming appearance in the eyes of men (Luke 21:5). It was approximately 80 years in construction. Five years later it was utterly destroyed, and not one stone of the temple was left upon another (Luke 21:6).

11. *Other buildings of Herod in Jerusalem.*

About 9 B.C.—eight years from its commencement—the court and cloisters of the Temple were finished, and the bridge between the south cloister and the upper city (demolished by Pompey) was doubtless now rebuilt with that massive masonry of which some remains still survive. At this time equally magnificent works were being carried on in another part of the city, namely, in the old wall at

HEROD THE GREAT

the north-west corner, contiguous to the palace, where three towers of great size and magnificence were erected on the wall, and one as an outwork at a small distance to the north. The latter was called Psephinus, the three former were Hippicus, after one of his friends—Phasaelus, after his brother—and Mariamne, after his queen. Phasaelus appears to have been erected first of the three,¹² though it can not have been begun at the time of Phasaelus's death, as that took place some years before Jerusalem came into Herod's hands. The Temple continued afterward to receive fresh additions, besides the repairs of injuries done in frequent tumults, so that, when it was visited by our Lord at the beginning of his ministry (A.D. 27), it was said that the building had occupied the intervening forty years. Nor did it cease then; for Josephus places its completion by Herod Agrippa II. about A.D. 65, only five years before its final destruction; an act in which its finisher, and the great-grandson of its founder, was the ally of the Romans, A.D. 70. The great Agrippa, though a heathen, is connected with the Temple in another way. When on a visit to Herod, he propitiated the Jews by offering 100 oxen (a hecatomb), and feasted all the people, Herod having joined in his heathen sacrifices at Cæsarea. During this period, in fact, Herod was drawing closer to his patron. In the beginning of 14 B.C. he joined Agrippa in the Black Sea with a powerful fleet, and his services were rewarded by the addition of the territory to the east of the lake of Gennesareth, where Herod hunted the robbers of Trachonitis out of their mountain caves with wonderful vigor and relentless cruelty. Part of this region was formed into a tetrarchy for his brother Pheroras. He also procured from Agrippa the restoration of privileges and immunities to the Jews of the "Dispersion." On his return, in the autumn of the same year, he

12. Josephus, *Ant.*, XVII, 10, 2.

addressed the people assembled at the Feast of Tabernacles, and remitted them a fourth of the annual tax.

12. *Family troubles of Herod. Execution of his sons Aristobulus and Alexander.*

The eye turned from all this splendor to Herod's domestic life meets one of the most appalling spectacles in the pages of history. The source of all his cruelties is to be found in his usurpation. His jealousy was excited by the Asmonæan blood which flowed in the veins of his own sons by his marriage with Mariamne; and his conscience, ever reproaching him with her murder, prompted him to suspect her avengers in her children. Those who had urged him on to the condemnation of Mariamne had better reason for the like fears on their own account. So when Herod brought back Aristobulus and Alexander from their three years' residence at Rome, their destruction was already half prepared. Their fate was sealed by the enthusiasm of the people, who hailed in their graceful persons and popular manners the true scions of the Asmonæan house. Herod, who never displayed that morose depravity which loves wickedness for its own sake, treated the youths at first like a father. He married Alexander to Glaphyra, the daughter of Archelaus, king of Cappadocia, and Aristobulus to his cousin Berenice, the daughter of Salome. Even this union did not appease Salome's jealous ambition. With the aid of Herod's brother, Pheroras, she so far wrought on his fears as to induce him to send for ANTIPATER, his eldest son by Doris, whom he had divorced to marry Mariamne. Antipater proved a deadly and unscrupulous enemy to his brothers, who were at length carried by Herod before the tribunal of Augustus at Aquileia (13 B.C.). Herod was accompanied by NICOLAUS DAMASCENUS, the intimate friend both of Augustus and himself, whose eloquence was so often of service to the Herodian family. This distin-

guished rhetorician, a native of Damascus, and the son of Antipater and Stratonice, was the companion of Herod's studies, and his mediator with Augustus whenever some especially flagrant act of the Jewish king stirred the emperor's indignation. Nicolaus wrote lives of Augustus and of himself, and a Universal History. The emperor effected a reconciliation; but still Antipater was placed before the sons of Mariamne in the succession to the throne; and, being sent to Rome in the train of Agrippa, he tried in all his letters to renew Herod's suspicions against them. Herod's return from a visit to Rome, in 11 B.C., was again followed by an address to the people assembled at the Feast of Tabernacles, in which the announcement of Antipater as his successor—a prince not of the Amonæan blood—was recommended by new exemptions. The whole atmosphere of the court was poisoned with distrust. False accusers shared the fate of the accused; slaves were tortured to extract evidence; and at last Alexander was tempted to a most improbable confession. A fresh trial took place at Berytus before the Roman governors of Syria, Saturninus and Volumnus, with a court of 150 assessors, by a majority of whom the youths were condemned unheard, and Herod's claim to the power of life and death over them was confirmed. After some hesitation he caused them to be strangled at Sebaste.

13. *Herod's golden eagle torn down.*

In or about the year 7 occurred the affair of the Golden Eagle, a parallel to that of the theatre, and, like that, important, as showing how strongly the Maccabæan spirit of resistance to innovation on the Jewish law still existed, and how vain were any concessions in other directions in the presence of such innovations. Herod had fixed a large golden eagle, the symbol of the Roman empire, of which Judæa was now a province, over the entrance to the Sanc-

tuary, probably at the same time that he inscribed the name of Agrippa on the gate.¹⁸ As a breach of the second commandment—more than as a badge of dependence—this had excited the indignation of the Jews, and especially of two of the chief rabbis, who instigated their disciples to tear it down. A false report of the king's death was made the occasion of doing this in open day, and in the presence of a large number of people. Being taken before Herod, the rabbis defended their conduct and were burned alive. The high-priest Matthias was deposed, and Joazar took his place.

14. *Conspiracy of Herod's son Antipater and death of his brother Pheroras.*

To complete the series of his domestic tragedies, Herod's favored son, Antipater, conspired against his life with his favorite brother, Pheroras. The wife of Pheroras was connected with the Pharisees, 7000 of whom had refused to take the oath of allegiance, and she was accused of disseminating disloyal prophesies. Pheroras fell into disgrace; but in his last illness, which soon followed, Herod treated him with a kindness which moved him to abandon his designs. Upon his death, not without suspicion of poison, Herod instituted an inquiry; the whole plot was revealed, and proved by the confession of his wife. Antipater, who had gone to Rome to avoid suspicion, was returning to reap, as he supposed, the fruit of his parricide, when he was seized at Sebaste, brought to trial before Herod and Varus, the Roman governor of Syria, and condemned on the clearest evidence.

15. *Herod's last sickness; visit of the wisemen; Massacre of Bethlehem babes.*

While Antipater's doom awaited the confirmation of Augustus, Herod was seized with a most painful and loath-

18. Josephus, *Wars*, I, 21, 8.

HEROD THE GREAT

some disease. The increasing torments of his ulcerated body, which derived no benefit from the warm baths of Callirhoe, drove him to new acts of frenzied cruelty; but we may well doubt whether the fancy of what he *might* have felt does not prevail over sober fact in the statement that he ordered the representatives of the chief families of Judæa to be shut up in the hippodrome at Jericho and to be put to death as soon as he expired, that his funeral might not want mourners.

His rage and terror were brought to a climax by a new and strange danger, threatening the crown which had cost him so much. A caravan headed by persons of great distinction arrived at Jerusalem, making the omnious inquiry, "Where is he that is born KING OF THE JEWS?" and declaring that the star of his Nativity had guided them from the distant East. Herod well knew the significance of that title. His agitation was shared by all the people of Jerusalem, though doubtless from widely different feelings. Assembling the teachers of the law, he obtained their opinion, on the authority of the prophet Micah, that Bethlehem would be the birthplace of the Messiah. Secretly calling for the strangers, and having learned from them the precise time of the star's appearance, he sent them to Bethlehem, and bade them return to inform him when they had found the babe that he too might go and worship Him. Having in vain awaited their return, he resolved to rid himself of the dreaded rival by the massacre of all the babes in Bethlehem and its district from the age of two years old and under. The consummation of this sentence, and the escape of Jesus, belong to the next book of our history. We here regard the transaction from the point of view of Herod's life. Vast as we know the issues at stake to have been, we can hardly be surprised that, amid all the horrors of Herod's last days, the murder of some ten or

twelve children in a small country town¹⁴ escaped the notice of the Jews at the time, and of their historian afterward.

16. *Execution of Herod's son Antipater.*
Herod's death.

They soon had horrors enough in their very midst. The embassy returned from Rome, with the consent of Augustus to Herod's dealing as he pleased with his guilty son, though the milder alternative of banishment was suggested. About the same time, Herod attempted suicide in a paroxysm of agony. The rumor of his death spread through the palace. Antipater tried to bribe his jailer who reported the offer to Herod, and the tyrant's dying breath gave the order for his son's execution. It appears to have been in connection with the fate of Antipater, perhaps as the expression of his own disgust in yielding to the king's importunity, that Augustus uttered the celebrated sarcasm, "It is better to be Herod's hog than his son."—for his religion forbade his slaughtering the former. After using his last remnant of strength to give final directions about his will, he expired five days after the death of Antipater, shortly before the Passover, 4 B.C. He had just entered on the thirty-seventh year of his reign, dating from the edict which gave him the kingdom, and the thirty-fourth of his actual possession of the throne, dating from the death of Antigonus.¹⁵

14. Such is the result of a sober calculation, founded on our knowledge of Bethlehem. The accurate simplicity of St. Matthew (ii. 16-18) may be contrasted with the vague statements of the fathers that Herod slew "all the children in Bethlehem" (Justin and Origen), and with the exaggerated impressions made on us by the painters.

15. There is now no doubt that the common era of the birth of our Saviour is wrong by four years. Christ was born shortly before the death of Herod, and we know that the latter died four years before the Christian era.

17. *Character of Herod.*

Enough has appeared of Herod's abilities and vices in this summary of his reign. It is, perhaps, difficult to see in his character any of the true elements of greatness. Some have even supposed that the title—the *great*—is a mistranslation for the *elder*; and yet on the other hand he seems to have possessed the good qualities of Henry VIII with his vices. He maintained peace at home during a long reign by the vigor and timely generosity of his administration. Abroad he conciliated the good-will of the Romans under circumstances of unusual difficulty. His ostentatious display, and even his arbitrary tyranny, was calculated to inspire Orientals with awe. Bold and yet prudent, oppressive and yet profuse, he had many of the characteristics which make a popular hero; and the title which may have been first given in admiration of successful despotism now serves to bring out in clearer contrast the terrible price at which the success was purchased.

18. *Herod's relation to sacred history.*

It remains to say a word upon his relation to the whole course of Divine Providence in the history of the Jews. As a usurper of an alien race, and that the hated race of Edom, and the destroyer of the Asmonæan house and kingdom, he cleared the ground of all who might have lawfully competed with Christ for the throne of David; while his power united the Holy Land in preparation for the advent of its predicted King. Nor was even his personal character without its bearing on the coming of the Christ. No government, except perhaps one that maintains its power over an enslaved but noble people by brute force, is much worse in its moral character than the people who submit to it; and Herod is in some sense the representative of the deep moral degradation of the Jews. The

religious puritanism, which the bitter lesson of the Captivity had impressed on the Jewish Church, was still maintained, though only in outward form, by the Pharisees; and a remnant of its living spirit was preserved amid the fanaticism of the Essenes; but the more than half-heathen pomp of Herod too truly represented the worldly spirit which looked for an earthly kingdom as its highest hope. Nor are the family feuds which stained the house of Herod with perpetual blood without their deep significance. The palace gave the worst example, but still only an example; of that dissolution of the bonds of nature which the prophet Malachi had marked as a sign of His coming who alone could restore peace. The time was evidently at hand, when "Elijah the prophet (John the baptizer) should be sent before the coming of the great and dreadful day of the Lord: to *turn the heart of the fathers to the children, and the heart of the children to their fathers*, lest He could come and smite the earth with a curse." (Malachi 4:5-6).

19. *Jewish history in two streams after the time of Herod.*

Before Herod's reign had closed, both that Prophet (John the baptizer) and the Christ himself had been born. Their entrance into the world forms the subject now before us; but we shall be the better prepared to enter on the history of Christ and the Apostles by first taking a summary view of the princes of Herod's house who ruled in different parts of Palestine with different degrees of power, and of the Roman dominion in the country till the destruction of Jerusalem. In fact the history divides itself at Herod's death into two portions which intersect almost without mingling; that of Christ and his Church, and that of the Jews as a nation. The latter belongs rather to the history of the Old Covenant than of the New. It is the story of the last expiring effort of a noble but corrupted

HEROD THE GREAT

and mistaken people, to defend their supposed rights against the earthly masters to whose yoke they had already bowed, and against the spiritual Lord whom they resisted because they knew him not. Perhaps the devout student of the spiritual conflict is too often at a disadvantage for want to a comprehensive view of the external relations of the Jewish nation. This distinction is thus insisted on by the eloquent historian of the Jews:—"The history of the Jews after the death of Herod (not rightly named the Great) and the birth of Jesus separates itself into two streams: one narrow at first, and hardly to be traced in its secret windings into the world, but with the light of heaven upon it, and gradually widening till it embraces a large part of Asia, part of Africa, the whole of Europe, and becomes a mighty irresistible river—a river with many branches—gladdening the fertilizing mankind, and bearing civilization, as well as holiness and happiness, in its course;— the other at first as expansive, but gradually shrinking into obscurity, lost in deep, almost impenetrable, ravines; sullen apparently and lonely, yet not without its peculiar majesty in its continuous, inexhaustible, irrepressible flow, and not without its own peculiar influence as an undercurrent on the general life and progress of mankind; . . . Too often attempted to be cruelly dried up by violent means, or turned into blood, yet still emerging when seeming almost lost, and flowing on, as it still flows, and seems destined to flow. Though the Jewish and Christian history have much in common, they may be kept almost entirely distinct." This remark applies especially to what remains to be told of the house of Herod.

20. *The Herodian party.*

In the account which is given by St. Matthew (xxii. 15 ff.) and St. Mark (xii. 13 ff.) of the last efforts made by different sections of the Jews to obtain from our Lord him-

self the materials for his accusation, a party under the name of *Herodians* is represented as acting in concert with the Pharisees (Matt. xxii. 16; Mark xii. 13). St. Mark mentions the combination of the two parties for a similar object at an earlier period (Mark iii. 6), and in another place (viii. 15; cf. Luke xii. 1) he preserves a saying of our Lord, in which "the leaven of Herod" is placed in close connection with "the leaven of the Pharisees." In the Gospel of St. Luke, on the other hand, the Herodians are not brought forward at all by name.

These scanty references to the Herodian party tell us little about its adherents. But in the nature of the case two distinct classes might thus unite in supporting what was a domestic tyranny, as contrasted with absolute dependence on Rome: (1) those who saw in the Herods a protection against direct heathen rule which was the one object of their fear; and (2) those who were inclined to look with satisfaction upon such a compromise between the ancient faith and heathen civilization, as Herod the Great and his successors had endeavored to realize, as the true and highest consummation of Jewish hopes. On the one side the Herodians—partisans of Herod in the widest sense of the term—were thus brought into union with the Pharisees, on the other, with the Sadducees. Yet there is no reason to suppose that they endeavored to form any very systematic harmony of the conflicting doctrines of the two sects, but rather the conflicting doctrines themselves were thrown into the background by what appeared to be a paramount political necessity.

The Herodians gradually ceased to be a political group after Herod's death, as the Romans more and more took over direct rule of Judea and the surrounding Kingdoms.

21. *Roman Emperors' of New Testament Times.*

1. *Octavian (Augustus) Caesar* (27 B.C.-A.D. 14)

Augustus was ruling at the birth of Christ (Luke 2:1). He first fully established the power of the empire. He boasted that he found Rome brick and left it marble. He promoted peace and prosperity.

2. *Tiberius Caesar* (A.D. 14-37)

Tiberius was emperor during Christ's ministry and death (Luke 3:1). He was the adopted son of Augustus. He was suspicious, haughty, cruel, and never popular with the people.

3. *Caligula* (A.D. 37-41)

Caligula was mentally unstable and tyrannical. He tried to erect a statue of himself in the Jerusalem temple. He was assassinated by one of the imperial guards.

4. *Claudius* (A.D. 41-54)

Claudius was an able ruler, but he had an idiotic physical appearance. In his time Rome became a bureaucracy. He expelled the Jews from Rome after a disturbance there over the "Chrestus" (Acts 18:2). He took Agrippina as his fourth wife; she was the mother of Nero.

5. *Nero* (A.D. 54-64)

Nero ruled well for five years. He murdered his mother in A.D. 59. He became careless, extravagant, and cruel. Rome burned in A.D. 64, and the Christians were blamed for this. He instigated the first Roman persecution against Christians. His troops revolted against him, and he ordered one of his guards to kill him.

1. For further information about these Roman emperors, see Merrill C. Tenny, *New Testament Survey*, Grand Rapids, Eerdmans, 1961, p. 1 ff.

NEW TESTAMENT BACKGROUNDS

6. *Galba* (A.D. 68)

He was appointed by the army, and slain by the army.

7. *Otho* (A.D. 69)

He was killed in the battle with Vitellius, the Roman legate of Germany.

8. *Vitellius* (A.D. 69)

Vitellius was slain by troops of the Roman general Vespasian.

9. *Vespasian* (A.D. 69-79)

Vespasian was a plain, stern, honest, vigorous, old soldier, burly and bald-headed. He built the Colosseum. Jerusalem was destroyed during his reign.

10. *Titus* (A.D. 79-81)

Titus actually was the one who destroyed Jerusalem, while his father Vespasian was ruling. He was handsome, popular, and generous. Pompeii was destroyed by the volcano Vesuvius during his reign.

11. *Domitian* (A.D. 81-96)

Domitian was the second son of Vespasian. He was autocratic and demanded worship for himself. He instigated the second Roman persecution against Christians. He was suspicious and harsh. He was assassinated. He was probably emperor when the book of Revelation was written.

12. *Nerva* (A.D. 96-98)

Nerva was an older man, mild in nature.

13. *Trajan* (A.D. 98-117)

Trajan was an energetic, professional soldier. He put down numerous rebellions, and annexed new territories to the Roman empire.

SECTION V

HISTORY FROM DEATH OF HEROD
TO THE DESTRUCTION OF JERUSALEM
(4 B.C.—A.D. 70)

1. Family of Herod the Great. 2. Will of Herod. 3. Funeral of Herod. 4. The Jews' opposition to Archelaus. 5. Augustus confirms Herod's will. 6. Rule of Archelaus; his banishment. 7. Herod Antipas, Herodias, and John the baptist. 8. Herod Antipas joins Pilate in condemning Christ. 9. Banishment of Herod Antipas. 10. Herod Philip, tetrarch of northern Perea; City of Caesarea-Philippi. 11. Judea under procurators: (1) Sabinus, (2) Coponius. 12. Judean procurators: (3) Ambivus, (4) Rufus, (5) Valerius Gratus, (6) Pilate. 13. Pilate's tyranny; his banishment. 14. Benefits to the Jews by Vitellius. 15. Caligula tries to place his statue in the temple. 16. Persecutions of the Jews in Alexandria. 17. Philo heads mission to Caligula to defend Jews. 18. Resistance to Caligula in Judea; His decree suspended; His death. 19. Herod Agrippa I made King of Judea. 20. Agrippa I favors the Jews. 21. Agrippa fortifies Jerusalem. 22. Agrippa kills apostle James. 23. Magnificence of Agrippa I; his horrible death. 24. Career of Herod Agrippa II. 25. Judea again under procurators: (7) Fadus. 26. Famine in Judea; Queen Helena; Paul and Barnabas visit Jerusalem. 27. Procurators (8) Alexander, and (9) Cumanus; Tumult at the Passover. 28. Cruel procuratorship of (10) Felix. 29. Able, upright (11) Festus. 30. Procurator (12) Albinus; increasing bloodshed throughout the land. 31. Last and worst procurator, (13) G. Florus. 32. Outbreak of Jewish revolt against the Romans. 33. Initial victories of the Jews. 34. Principal men of the war. 35. Romans conquer whole country; temporary suspension of the siege of Jerusalem. 35. Titus' siege of Jerusalem. 36. Burning of the temple. 37. Final capture of Jerusalem. 38. Fall of Masada. 39. Jerusalem after its fall. 40. The Bar-Cochba revolt. 41. Hadrian makes Jerusalem a pagan city.

WATCH FOR ANSWERS
TO THESE QUESTIONS:

- 1-5. How were the following people related to Herod the Great: (1) Archelaus, (2) Herod Antipas, (3) Herod Philip II, (4) Herod Agrippa I, (5) King Agrippa II?
6. Who governed Galilee and Perea after the death of Herod the Great?
7. What position did Archelaus receive in Herod's last will?
8. Where was Herod's funeral?

NEW TESTAMENT BACKGROUNDS

9. How many died in Jerusalem when the people raised an outcry near the start of Archelaus' reign?
10. How did the Roman officials treat Jerusalem and the Jews very shortly after Herod's death?
11. What expectation among the Jews rose to a great climax about the time of Archelaus?
12. Was the will of Herod concerning his successors generally confired? By whom?
13. How was Archelaus removed from office?
14. What two Biblical events involve Herod Antipas?
15. What was objectionable about Herod Antipas' marrying Herodias?
16. What was the name of Herodias' daughter?
17. When did Herod Antipas and Pilate become friends?
18. Who brought about the banishment of Herod Antipas?
19. Who founded the city of Tiberias? Where is it?
20. What was the character of Herod Philip II?
21. Where is the city of Cæsarea Philippi? Who built it?
22. What was a Roman *procurator*?
23. What did the Samaritans do that caused them to be excluded from the Jerusalem temple?
24. Name the Roman procurator immediately preceding Pontius Pilate.
25. Pilate transferred the winter quarters of Roman troops from where to where?
26. Did Pilate get along well with the Jews?
27. Who banished Pilate? To where?
28. What Roman emperor tried to get his statue placed in the temple at Jerusalem?
29. In what city did the Jews endure a terrible persecution during the time of Caligula?
30. What famous Alexandrian Jew headed a mission to Caligula at Rome to defend the Jews?
31. Who got the decree to erect in Jerusalem a statue to Caligula suspended?

THE HERODS, THE JEWS, AND ROME

32. Whom did the Roman emperor Claudius make king of Judea and Samaria?
33. Was king Agrippa I friendly or hostile to the Jews?
34. What part (north, south, east, west) of Jerusalem did Agrippa enclose with a new wall?
35. Which apostle did Herod Agrippa kill? Which one did he imprison?
36. How did Herod Agrippa I die?
37. What area did Agrippa II rule?
38. With what woman was Agrippa II associated?
39. Which apostle was "tried" before Agrippa II?
40. What foreign queen imported relief foods to the Jews at Jerusalem?
41. What tragedy occurred in Jerusalem in the time of the procurator Cumanus?
42. What was the character of Felix the procurator? Was he friendly to the Jews?
43. What were the *Sicarii*?
44. What was the state of Jewish society in the time of Felix?
45. What connection did Felix have with the apostle Paul?
46. When was James, the brother of Christ, "delivered to be stoned"?
47. What were Jewish social conditions like in the time of Albinus the procurator?
48. Was Judea's last procurator good or bad?
49. What was the effect of Florus' attempt to get treasures from Jerusalem?
50. What act was the specific starting point of the Jewish rebellion and war against Rome? What Jewish historian tells us of this war?
51. How much of the country was captured before Jerusalem itself was finally besieged by the Romans?
52. Where was Vespasian when he received news of Nero's death?

NEW TESTAMENT BACKGROUNDS

53. What Roman finished the Jewish war when Vespasian left?
54. When did the Christians flee from Jerusalem? Where did they go?
55. Which party got control in Jerusalem, the moderates or the Zealots?
56. What was the year when Jerusalem finally fell?
57. Why were so many people in Jerusalem when its last siege began?
58. How many people does Josephus say perished in the siege?
59. What did Titus build around Jerusalem?
60. Did Titus actually intend to burn the temple?
61. How much of Jerusalem was burned? What was left standing?
62. What cliff fortress fell to the Romans after the fall of Jerusalem?
63. Was Jerusalem inhabited in the fifty years after its fall?
64. Who became leader of the Jews in the second Jewish revolt?
65. In what year was the second Jewish revolt? How long did it last?
66. Who was the Roman emperor during the second Jewish revolt?
67. What temple did Hadrian erect on the site of the Jerusalem temple?
68. What did Hadrian rename Jerusalem?
69. Who was allowed to live at Jerusalem after the second revolt?
70. When were Jews finally allowed to visit Jerusalem after the second revolt?
71. Where was the Jews' wailing-place in Jerusalem?

THE HERODS, THE JEWS, AND ROME

THE HERODIAN FAMILY.

- (1) Antipater (Antipas), Governor of Idumea (*Gen. Ant. xvi. 1, 3*).
 (2) Antipater—Cyrus (an Arabian; *Gen. Ant. xiv. 7, 9*).

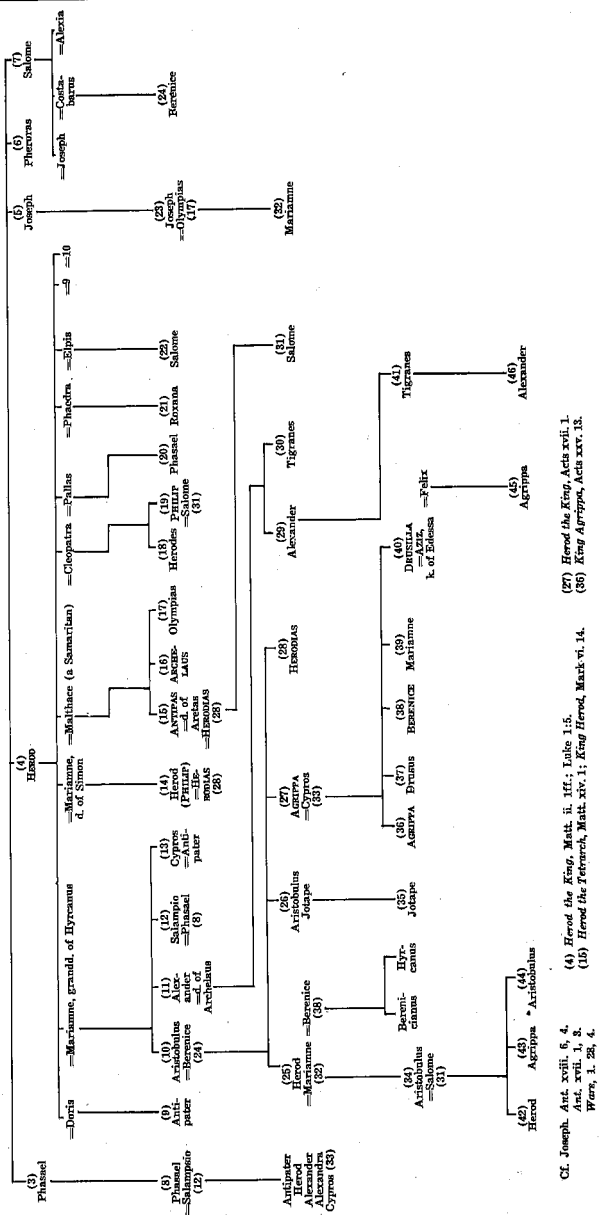

Cf. Joseph. Ant. xviii. 5, 4. (4) Herod the King, Matt. ii. 19f.; Luke 1.5. (27) Herod the King, Acts xvii. 1. (12) Antipater, Acts xxi. 38. (15) Herod the Tetrarch, Matt. xxiv. 1; King Herod, Mark vi. 14. (38) King Agrippa, Acts xxv. 13.

The family relations of the Herods are singularly complicated from the frequent recurrence of the same names, and the several accounts of Josephus are not consistent in every detail. The members of the Herodian family who are mentioned in the N. T. are distinguished by capitals. A double line indicates a marriage.

In order to understand fully the history of our Saviour and his Apostles, it is necessary to give a brief account of the secular history of the Jews during this period.

1. *Family of Herod the Great.*

The family of Herod is shown in the genealogical table. Of his ten wives, we need only notice the offspring of the first five. (i.) He married *Doris* before his accession to the throne; and her only son ANTIPATER was, as we have seen, the last victim of his father's dying rage. (ii.) ARISTOBULUS, *his eldest son by Mariamne*, the granddaughter of Hyrcanus, was the parent of a large family, and from him were descended the two AGRIPPAS, the first of whom was the "KING HEROD" who slew James and imprisoned Peter (Acts 12:1); the second, the "KING AGRIPPA" before whom Paul pleaded (Acts 25-26). (iii.) After the judicial murder of Mariamne, Herod married another *Mariamne*, daughter of the high-priest, Simon; her son was HEROD PHILIP, whose marriage with his niece Herodias, daughter of Aristobulus, followed by her divorce of him to marry his half-brother, Herod Antipas, led to the martyrdom of John the Baptist. He is often confounded with his half-brother PHILIP, the tetrarch of Iturea. (iv.) His next wife, *Malthace*, a Samaritan, was the mother of HEROD ANTIPAS and ARCHELAUS, of whom we have presently to speak. (v.) By *Cleopatra* he had two sons, the younger of whom was PHILIP, the tetrarch of Ituræa and the adjacent district with Trachonitis. (vi.-x.) His other wives and their children are of no consequence in the history. These complicated relations will be made clearer by the following outline of the chief personages with whom the history is concerned, for the four generations of the family:

THE HERODS, THE JEWS, AND ROME

A. HEROD THE GREAT.

<i>Wives</i>	<i>Sons</i>	
I. Doris	1. Antipater	}
of Hyrcanus II.	2. Aristobulus	
II. Mariamne, grandd.	3. Alexander	
III. Mariamne, d. of Simon	4. HEROD PHILIP I.	} Lived as a private per- son.
IV. Malthace, a Samaritan	5. HEROD ANTIPAS	
	6. ARCHELAUS	Ethnarch of Judæa.
IV. Cleopatra	7. HEROD PHILIP II.	} Tetrarch of Northern Peræa, etc.
	m. Salome, d. of Philip I. and Herodias.	

B. Children of Aristobulus.

1. Herod Agrippa I
2. Herodias, m.—
 (1) Herod Philip I.
 (2) Herod Antipas.

C. Children of HEROD AGRIPPA I.

- | | | |
|--------------------------------|--|-------------------------------|
| 1. Herod Agrippa II. | | Tetrarch of N. Peræa,
etc. |
| 2. Bernice | | Named in Acts xxv. 23. |
| 3. Drusilla, m. to Felix | | Named in Acts xxiv. 24. |

2. Will of Herod the Great.

During his last illness, Herod made a will in favor of the sons of Malthace (Archelaus and Antipas), who had been educated at Rome, and had been at first excluded from the inheritance through the accusations of Antipater. It was this unexpected arrangement which led to the retreat of Joseph to Galilee on his return with Mary and Jesus from Egypt (Matt. 2:22). The elder of them, Herod Antipas, was first named by Herod his successor; but the last change in the king's will transferred that dignity to Archelaus, leaving to Antipas the government of Galilee and Peræa (in the narrower sense), with the title of tetrarch. The northern part of the trans-Jordanic country, including Ituræa, Gaulonitis, and Batanæa, with Trachonitis, were made a tetrarchy for Philip, the son of Cleopatra. Lastly,

Herod's will left an ample provision to his sister Salome, whose intrigues had been so fatal to his family, and large legacies to Augustus and his wife Julia. Herod Philip, the son of the second Mariamne, was excluded from all benefit of his father's will, in revenge for the supposed treason of his mother; as were also the descendants of the first Mariamne.

3. *Funeral of Herod the Great.*

Pending the ratification of Herod's will by Augustus, Archelaus succeeded to his father's power. The Jewish princes were released from the hippodrome, and the funeral of Herod was celebrated with great splendor. Herod died at Jericho. The funeral is thus described by Dean Milman:—"The lifeless remains of Herod seemed to retain his characteristic magnificence. The body was borne aloft on a bier, which was adorned with costly precious stones. The linen was of the richest dye; the winding-sheet of purple. It still wore the diadem, and, above that, the golden crown of royalty: the sceptre was in its hand. The sons and relatives of Herod attended the bier. All the military force followed, distributed according to their nations. First, his body-guard—then his foreign mercenaries, Thracians, Germans, Gauls—then, the rest of the army, in war array. Last came five hundred of his court-officers, bearing sweet spices, with which the Jews embalmed the dead. In this Pomp the procession passed on, by slow stages, to the Herodium, a fortified palace, about twenty miles from Jericho" (and four miles southeast of Bethlehem).

4. *The Jews' opposition to Archelaus.*

At the end of the seven days' mourning, during which it was rumored that the pious duties of the day were relieved by nights of revelry, Archelaus gave a funeral feast

THE HERODS, THE JEWS, AND ROME

to the people, and then made a solemn entry in the Temple. His speech, in which he assumed a tone of great moderation, and promised relief from his fathers tyranny, was received with loud applause, not unmingled with cries for the redress of grievances. "Some called for a diminution of the public burdens; others for the release of the prisoners, with whom Herod had crowded the dungeons; some more specifically for the entire abandonment of the taxes on the sale of commodities in the markets, which had been levied with the utmost rigor. Archelaus listened with great affability, promised largely, and, having performed sacrifice, retired."

The disaffection, which was doubtless inflamed by disappointment of the hopes founded on the milder character of Herod Antipas, the expected heir, broke out into open tumult while the two brothers were preparing to start for Rome, the one to seek the emperor's confirmation of Herod's will, the other to urge his claims. At the Feast of the Passover when Jerusalem was always filled with devout Jews, whose zeal was inflamed by their numbers and by the exaltation of feeling due to the festival, a cry was raised for vengeance on behalf of those whom Herod had executed for pulling down the eagle. The multitude were only dispersed by army force with the slaughter of 3000 men and the feast was broken off. Archelaus now set out for Rome. In his train were Nicolas of Damascus, whose eloquence had so well served his father, and Salome, who was secretly prepared to urge the claims of Herod Antipas.

Meanwhile the rapacity of the Roman officials grasped at what appeared an easy prey. Even while preparing to embark at Cæsarea, Archelaus had met Sabinus the procurator of Syria on his way to claim the late king's treasures. His march, suspended at the entreaties of Archelaus and the command of Varus, the prefect of Syria, was resumed

as soon as the former had sailed; and his exactions gave the zealots the provocation or pretext for a tumult which was only put down by the interference of Varus. Sabinus, left still in command at Jerusalem, soon provoked a new insurrection at the Feast of Pentecost when the city was again filled with zealots bent on avenging their repulse at the Passover. They formed a regular encampment round the Temple, and besieged Sabinus and his legion, probably in the Antonia. The Romans made a sally against the Temple, burned the cloisters of the outer court with its defenders, broke into the sanctuary, and plundered the sacred treasures; but the Jews, furious at the sacrilege, still besieged Sabinus and his legion. The anarchy of the country was inflamed by the troops of Herod, who wandered about in bands that fought and plundered as they pleased. To these elements of confusion was added the expectation of some great deliverer,—a feeling which now reached its climax,—and at the very time when the true Saviour was concealed in Egypt, false Messiahs were assuming the diadem, and gathering troops of banditti. Meanwhile Varus advanced to the relief of Sabinus, at the head of two legions, and among the auxiliaries were some Arabian bands who devastated the country. The insurgents laid down their arms at his approach; and Sabinus, ashamed to meet him, set off for Rome. Two thousand of the ringleaders were crucified, and others sent to Rome for trial. It had become plain that, whatever might be the decision of Augustus, he himself was the only master of Judæa.

The cause at issue before him was pleaded by the eloquence of Nicolas and Herod Philip (the elder) on the part of Archelaus, and by Salome and her son Antipater on that of Antipas. During its progress a deputation of 500 Jews appeared at the emperor's tribunal, praying for the suppression of royalty and the restoration of their liberties; and the statement that they were supported by no less than

8000 of their countrymen at Rome indicates the number and influence of the Jews settled in the capital.

5. *Augustus confirms Herod's will.*

At length, Augustus confirmed the will of Herod in all essential points. Archelaus was established in the government of Judæa, with Idumæa and Samaria, forming about half the kingdom of Herod, and bringing in a revenue of 600 talents. He was to rule under the title of *Ethnarch* (meaning, Ruler of the people) with the promise of that of *King* if he proved worthy of it. Of the chief cities in his territory, he retained Jerusalem, Sebaste, Cæsarea, and Joppa; while Gaza, Gadara, and Hippo were made Roman towns under the prefect of Syria; and Salome received Jamnia, Azotus, Phasaelis, and a palace in Ascalon. Herod Antipas was confirmed in the tetrarchy of Galilee and Peræa with a revenue of 200 talents, and Philip in that of Auranitis and Trachonitis.

6. *Rule of Archelaus; his banishment.*

We have seen that the first news of the succession of Archelaus led the parents of our Lord to turn aside on their way back from Egypt, and to place their precious charge under the milder government of Herod Antipas. The fear of Joseph may be taken as an expression of the popular distrust of Archelaus which was amply justified by the continued tyranny and disorder of his nine years' reign. At first, he showed a desire to conciliate the Jews by displacing Joazar whom Herod had made high-priest after the affair of the eagle in favor of his brother Eleazar. But the adherents of the Law were alienated by the marriage of Archelaus to Glaphyra, his brother Alexander's widow, for whom he divorced his wife Mariamne; and at length his tyranny provoked his subjects to appeal to Au-

gustus. Archelaus was summoned suddenly to Rome, and banished to Vienna (*Vienne*) in Gaul (A.D. 7). This sentence put a final end to the Jewish monarchy; for the restoration of a nominal kingdom for a few years under Herod Agrippa I. (A.D. 41-44) can only be viewed as an episode in the Roman domination. "The sceptre had departed from Judah" (Gen. 49:10).

7. *Herod Antipas, Herodias, and John the baptist.*

Before pursuing the history of Judæa as a Roman province, it will be convenient to follow the course of the two other sons of Herod, who reigned in Palestine according to his will. HEROD ANTIPAS, the brother of Archelaus, was confirmed by Augustus, as we have seen, in the tetrarchy of Galilee and Peræa, which had been assigned to him by his father's will, and hence he is mentioned in the Gospels by the style of HEROD THE TETRARCH.¹ His whole importance is derived from his two appearances in the Gospel history, as first the hearer and then the murderer of John the Baptist, and as taking part with Pilate in the condemnation of our Lord. The first of these crimes was due to the fatal influence of Herodias, which at last brought him to his ruin. He had married a daughter of Aretas, king of Arabia Petræa (the same from whose governor at Damascus St. Paul was afterward in danger). While still living with her, he formed a connection of the most disgraceful character in the eye of the Jewish law. The notorious HERODIAS, daughter of Aristobulus, the son of Mariamne and Herod the Great, and consequently sister of Herod Agrippa I., was married to Herod Philip, who was her step-uncle, being the son of Herod and the second Mariamne; and she now deserted Philip to marry

1. *Tetrarch* means "Ruler of a fourth" (of the land); Matt. 14:1; Luke 3:1, 19; Acts 13:1. The title "King" in Mark 6:14 must be regarded as a title of courtesy.

Herod Antipas, who stood to her in the same relation. Besides that her husband and his wife were both alive, Antipas, as the half-brother of Philip, was already connected with Herodias by an affinity so close that there was only one case contemplated in the law of Moses where it could be set aside, namely, when the married brother had died childless.² Now Herodias had already one daughter, Salome, by Philip. Well therefore may she be charged by Josephus with the intention of confounding her country's institutions, and well may John the Baptist have remonstrated against the enormity of such a connection with tetrarch, whose conscience would certainly seem to have been less hardened than hers; for he "feared" his reprover, whose preaching he had "heard gladly," and though these impressions did not avail to keep him from adding murder to adultery, he "was sorry" to commit the crime.³ Aretas made war to avenge his daughter; and we have the express testimony of Josephus that the defeat of Herod with the loss of nearly all his army was viewed by the Jews as a judgment for John's murder (Josephus, *Ant.* xxviii, 5, 1-2).

8. *Herod Antipas joins Pilate in condemning Christ.*

Free from his father's tyrannical temper, Herod Antipas aspired to be the patron and protector of the Jews, and he ventured on an open quarrel with the Roman procurator, possibly concerning those "Galileans whose blood Pilate had mingled with their sacrifices" (Luke 13:1). Herod courted favor with the strict Jews by his visit to Jerusalem at the Passover; and the Roman procurator thought it prudent to avail himself of such an opportunity for a reconciliation by sending Jesus before Herod, who, as tetrarch, had jurisdiction over a Galilean, and as the

2. See Lev. 18:16; 20:21; and for the exception, Deut. 25:5 ff.

3. Matt. 14:9; Mark 6:20; Josephus states that John was executed at Machærus, a fortress about five miles east of the Dead Sea.

head of the Herodian house, might gratify his hatred of "the king of the Jews." Such was the conjunction of political interests and passions by which "both Herod and Pontius Pilate with the Gentiles and the people of Israel, were gathered together" to fulfill the divine counsels as foretold by David (Acts 4:25-28; cf. Ps. 2:1-2).

These two chief passages of his life reveal the character of this weak, sensual, and superstitious prince, whose cunning was stamped by the Saviour with the epithet "that fox" (Luke 13:32). He would have been pleased to have kept both John and Jesus as prophets at his court, but was led by wanton weakness to sacrifice the one, and through the terror engendered by remorse, "would have killed" the other (Luke 13:31; Mark 6:16). He at last indulged his spite upon Jesus when he saw him safe as a prisoner to Pilate. What is left untold of his character and deeds is summed up in the significant phrase, which St. Luke adds to the record of his adultery with Herodias, "all the wickedness which Herod had done" (Luke 3:19).

9. *Banishment of Herod Antipas.*

At length the favors heaped by the emperor Caligula (who succeeded Tiberius in A.D. 37) upon his friend and comrade, Herod Agrippa, excited the jealous ambition of Herod Antipas. At the instigation of Herodias, he sailed with her to Rome, nominally to petition for the same royal title which had been conferred upon his nephew, but really to intrigue against him. But Agrippa, the bosom friend of Caligula, met the plot by a charge of treason against his uncle; and Antipas was banished to Lugdunum in Gaul⁴ (A.D. 39). It deserves to be recorded of Herodias that she preferred sharing the exile of Antipas till death ended his

4. In Josephus *Wars*, ii. 9, 6, Antipas is said to have died in Spain, apparently, from the context, the land of his exile. A town like Lyon near the borders of both Spain and Gaul would account for the apparent discrepancy.

reverses to remain with her brother Agrippa and partaking of his elevation.⁵

The city of TIBERIAS which Antipas founded on the west shore of the sea of Galilee and named in honor of the emperor was the most conspicuous monument of his long reign; but, like the rest of the Herodian family, he showed his passion for building cities in several places, restoring Sepphoris, near Tabor, which had been destroyed in the wars after the death of Herod the Great,⁶ and Betharamptha (Beth-haram) in Peræa, which he named Julias, "from the wife of the emperor."⁷

10. *Herod Philip, tetrarch of northern Perea; city of Caesarea-Philippi.*

HEROD PHILIP II.⁸ was the son of Herod the Great and Cleopatra. Like his half-brothers Antipas and Archelaus, he was brought up at home, and on the death of his father advocated the claims of Archelaus before Augustus. He received as his own government "Batanæa, Trachonitis, Auranitis (Gaulonitis), and some parts about Jamnia,"⁹ with the title of tetrarch. His rule was distinguished by justice and moderation,¹⁰ and he appears to have devoted himself entirely to the duties of his office without sharing in the intrigues which disgraced his family.¹¹ He built a new

5. Josephus, *Ant.* xviii, 7, 2.

6. Josephus, *Ant.* xvii, 12, 9; xviii, 2, 1.

7. Josephus, *Ant.* xviii, 2, 1.

8. The numeral is used to distinguish him from his half-brother Herod Philip I (Mark vi. 17), the son of Herod the Great and Mariamne the daughter of a high-priest Simon (Joseph. *Ant.* xviii. 6, 4), the husband of Herodias, and father of Salome. He is called only Herod by Josephus, but the repetition of the name Philip is fully justified by the frequent recurrence of names in the Herodian family (e.g. Antipater). The two Philips were confounded by Jerome; and the confusion was the more easy, because the son of Mariamne was excluded from all share in his fathers possessions in consequence of his mother's treachery (Josephus, *Wars*, i, 30, 7), and lived afterwards in a private place.

9. Josephus, *Wars*, ii, 6, 3; Luke 3:1.

10. Josephus, *Ant.* xvii, 2, 4.

11. Josephus, *Ant.* xviii, 5, 6.

city on the site of Paneas, near the sources of the Jordan, which he called Cæsarea, (Matt. 16:13; Mark 8:27), and raised Bethsaida (in lower Gaulonitis) to the rank of a city under the title of Julias, and died there A.D. 34.¹² He married Salome, the daughter of Philip I. and Herodias, but, as he left no children, his dominions were added at his death to the Roman province of Syria.

The city of Cæsarea Philippi, chosen by Philip the tetrarch as the site of his villas and palaces, besides his father's temple to Augustus, is distinguished not only by the unrivaled beauty of its site, but also by its sacred associations. "As it is the northernmost frontier of Palestine, so it is the northernmost limit of the journeys of our Lord. . . . It must at least have been in its neighborhood that the confession of Peter was made; the rock on which the temple of Augustus stood, and from which the streams of the Jordan issue, may possibly have suggested the words which now run round the dome of St. Peter's."

11. *Judea under procurators: (1) Sabinus,
(2) Coponius.*

Judæa, including Samaria, was reduced on the banishment of Archelaus to an ordinary Roman province under a procurator subordinate to the prefect of Syria.¹³ He re-

12. Josephus, *Ant.* xviii, 5, 6.

13. A *procurator* was generally a Roman knight, appointed to act under the governor of a province as collector of the revenue, and judge in causes connected with it. Strictly speaking, *procuratores Caesaris* were required only in the imperial provinces, *i.e.*, those which, according to the constitution of Augustus, were reserved for the special administration of the emperor, without the intervention of the senate or the people, and governed by his legate. In the senatorian provinces, governed by proconsuls, the corresponding duties were discharged by *quæstors*. Yet it appears that sometimes *procuratores* were appointed in those provinces also to collect certain dues of the *fiscus* (the emperor's special revenue), as distinguished from the revenue administered by the senate. Sometimes in a small territory, especially in one contiguous to a larger province and dependent upon it, the procurator was head of the administration, and had full military and judicial authority, though he was responsible to the governor of the neighboring province.

sided, not at Jerusalem, but at Cæsarea on the coast.¹⁴ SABINUS had already held the office during the absence of Archelaus, on whose deposition COPONIUS accompanied Quirinus to the country. Quirinus (the Cyrenius of the N. T.)—now for the second time prefect of Syria (A.D. 6-9)—was charged with the unpopular measure of the enrolment or assessment of the inhabitants of Judæa. Notwithstanding the riots which took place elsewhere, at Jerusalem the enrolment was allowed to proceed without resistance owing to the prudence of Joazar again high-priest for a short time. One of the first acts of the new governor had been to take formal possession of the state vestments of the high-priest, worn on the three Festivals and on the Day of Atonement. Since the building of the Baris by the Maccabees these robes had always been kept there, a custom continued since its reconstruction by Herod. But henceforward they were to be put up after use in an underground stone chamber, under the seal of the priests, and in charge of the captain of the guard. Seven days before use they were brought out, to be consigned again to the chamber after the ceremony was over.¹⁵

Two incidents at once most opposite in their character, and in their significance to that age and to ourselves, occurred during the procuratorship of Coponius. First, in A.D. 8, the finding of Christ in the Temple. Annas had been made high-priest about a year before. The second occurrence must have been a most distressing one to the Jews, unless they had become inured to such things. But of this we can not so exactly fix the date. It was nothing less than the pollution of the Temple by some Samaritans, who secretly brought human bones and strewed them about the cloisters during the night of the Passover. (Cf. II Kings

14. Josephus, *Ant.* xviii, 3, 1.

15. Josephus, *Ant.* xviii, 4, 3.

23:14). Up to this time the Samaritans had been admitted to the Temple; they were henceforth excluded.

12. *Judean procurators: (3) Ambivius, (4) A. Rufus, (5) Valerius Gratus, (6) Pilate.*

In or about A.D. 10 Coponius was succeeded by M. AMBIVIUS, and he by ANNIUS RUFUS. In A.D. 14 the emperor Augustus died, and with Tiberius came in a new procurator, VALERIUS GRATUS, who held office till 26, when he was replaced by PONTIUS PILATUS. During this period the high-priests had been numerous, but it is only necessary here to say that when Pilate arrived at his government the office was held by JOSEPH CAIAPHAS, who had been appointed but a few months before. The name of Pilate indicates that he was connected, by descent or adoption, with the family of the Pontii, first conspicuous in Roman history in the person of C. Pontius Telesinus, the great Samnite general. He was the sixth Roman procurator of Judæa, and under him our Lord worked, suffered, and died, as we learn not only from the obvious Scriptural authorities, but from Tacitus.

A corner stone bearing the incised name of Pontius Pilate was found at the ruins of Cæsarea in 1961. This is the only known contemporary relic mentioning Pilate. (See *Biblical Archaeologist*, Sept. 1964, p. 70).

13. *Pilate's tyranny; his banishment to Gaul.*

The freedom from disturbance which marked the twenty years at Jerusalem prior to Pilate's taking office was probably due to the absence of the Roman troops, who were quartered at Cæsarea, out of the way of the fierce fanatics of the Temple. But Pilate transferred the winter-quarters of the army to Jerusalem,¹⁶ and the very first day

16. Josephus, *Ant.* xviii, 3, 1.

there was a collision. The offense was given by the Roman standards—the images of the emperor and of the eagle—which by former commanders had been kept out of the city. Pilate had been obliged to send them in by night, and there were no bounds to the rage of the people on discovering what had thus been done. They poured down in crowds to Cæsarea, where the procurator was then residing, and besought him to remove the images. After five days of discussion, he gave the signal to some concealed soldiers to surround the petitioners and to put them to death unless they ceased to trouble him; but this only strengthened their determination, and they declared themselves ready rather to submit to death than forego their resistance to an idolatrous innovation. Pilate then yielded, and the standards were by his orders brought down to Cæsarea.¹⁷ Afterward, as if to try how far he might go, he consecrated some gilt shields—not containing figures, but inscribed simply with the name of the deity and of the donor—and hung them in the palace at Jerusalem. This act again aroused the resistance of the Jews; and on appeal to Tiberius they were removed. Another riot was caused by his appropriation of the Corban—a sacred revenue arising from the redemption of vows.¹⁸—to the cost of an aqueduct which he constructed for bringing water to the city.¹⁹ To these specimens of his administration which rest on the testimony of profane authors, we must add the slaughter of certain Galileans mentioned in Luke 13:1-3. The clear testimony thus borne to his sanguinary tyranny sets in a striking light the meanness of his attempt to conciliate the Jews and avoid the threat of a denunciation of Cæsar by the sacrifice of Jesus. Pilate's tyranny continued after that event, till, A.D. 37, the loud complaints of the Samaritans determined Vitellius, the prefect of Syria and father of

17. Josephus, *Ant.* xviii, 3, 1-2; *Wars*, ii, 9.

18. Compare Mark 7:11.

19. Josephus, *Wars*, ii, 9, 4.

the emperor, to send the procurator for trial to Rome. He arrived just after the death of Tiberius; and one of the praiseworthy acts which marked the beginning of Caligula's reign was his banishment to Vienna in Gaul, where a monument still bears the very doubtful title of the tomb of Pontius Pilate.

14. *Benefits to the Jews by Vitellius.*

After Pilate had been recalled to Rome, Jerusalem was visited by VITELLIUS, the prefect of Syria, at the time of the Passover. This visit was connected with the war, already noticed, between Herod Antipas and the Arabian king Aretas. In consequence of the victory of the latter, Vitellius set his army in motion to attack Petra; and it was on his march that he visited Jerusalem. Besides forbearing to insult the people by the display of his standards, Vitellius conferred two great benefits on the city. He remitted the taxes levied on produce, and he allowed the Jews again to have the free custody of the high-priest's vestments. He removed Caiaphas from the high-priesthood, and gave it to Jonathan, son of Annas. He then departed, apparently leaving a Roman officer²⁰ in charge of the Antonia. Vitellius was again at Jerusalem this year, probably in the autumn, with Herod that tetrarch;²¹ while there he again changed the high-priest, substituting for Jonathan, Theophilus his brother. The news of the death of Tiberius and the accession of Caligula reached Jerusalem at this time; and it was the interruption thereby caused to the operation of Vitellius that emboldened Aretas to seize Damascus, a circumstance of great importance in the chronology of Paul's life (II Cor. 11:32). MARCELLUS was appointed procurator by the new emperor.

20. Josephus, *Ant.* xviii, 4, 3.

21. Josephus, *Ant.* xviii, 5, 3.

15. *Caligula tries to place his statue in the temple.*

In A.D. 40, Vitellius was superseded by P. PETRONIUS, who arrived in Palestine with an order to place in the Temple a statue of Caligula. This outrage was connected with events which throw an interesting light on the relations of the Jews, in their various branches to the imperial supremacy. "Up to the reign of Caligula,"²² says Dean Milman, "the Jews had enjoyed without any serious interruption the universal toleration which Roman policy permitted to the religion of the subject states. If the religion had suffered a temporary proscription at Rome under Tiberius, it was a foreign superstition, supposed, from the misconduct of individuals, to be dangerous to the public morals in the metropolis. Judaism remained undisturbed in the rest of the empire; and, although the occasional insolence of the Roman governors in Judæa might display itself in acts offensive to the religious feelings of the natives, yet the wiser and more liberal, like Vitellius, studiously avoided all interference with that superstition which they respected or despised. But the insane vanity of Caligula made him attempt to enforce from the whole empire those divine honors which his predecessors consented to receive from the willing adulation of their subjects. Everywhere statues were raised and temples built in honor of the deified emperor. The Jews could not submit to the mandate without violating the first principle of their religion nor resist it without exposing their whole nation to the resentment of their masters.

22. The proper name of this emperor by which he is always called by the chief Roman historians, as well as in official documents—was Caius Cæsar. *Caligula* (*little boot*) was a nickname due to the humorous fondness of the soldiers, with whom he lived as a child in the camp of his father Germanicus. But it seems not an inappropriate accident which has affixed a mere nickname, in the page of history, to a mad prince of whom a Gaul said to his face—"I think you a great absurdity."

16. *Persecutions of Jews in Alexandria.*

The storm began to lower around them: its first violence broke upon the Jews in Alexandria, where, however, the collision with the ruling authorities first originated in the animosities of the Greek and Jewish factions which divided the city. This great and populous capital, besides strangers from all quarters, was inhabited by three distinct races, the native Egyptians, Jews, and Greeks. The native Egyptians were generally avoided as of an inferior class; but the Jews boasted of edicts from the founder of the city, and from other monarchs of Egypt, which entitled them to equal rank and estimation with descendants of the ancient Macedonian settlers. They were numerous: Philo calculates that in Egypt they amounted to a million of souls.²³ They were opulent and among the most active traders of that great commercial metropolis. It is probable that they were turbulent, and not the peaceful and unoffending people described by their advocate Philo—at all events they were odious to the Greek population.”

The prefect Valerius Flaccus whose firm and impartial government had hitherto kept the peace between the contending factions, finding his position endangered upon the accession of Caligula, sought to ingratiate himself with the Alexandrian Greeks by giving them license to insult the Jews. The arrival of Herod Agrippa, on his way to assume the principality conferred on him by Caligula, furnished a butt for the Greeks' insolence; and having vented their wanton humor in a mockery of his royal state they proceeded on his departure to more serious outrages. They set up statues of the emperor in the Jewish places of worship; and the Jews, compelled by an edict of Flaccus to keep themselves within the two quarters of the city which were peopled exclusively by them, though many resided

23. This included the Jews in Alexandria, and scattered settlers up to the borders of Ethiopia.

THE HERODS, THE JEWS, AND ROME

in the other three, lost heavily by the compulsory removal, and began to suffer from pestilence and famine in the crowded quarters in which they were almost besieged. "Those who ventured out into the market were robbed, insulted, maltreated, pursued with sticks and stones. Bloodshed soon ensued; many were slain with the sword, others trampled to death; some, even while alive, were dragged by their heels through the streets. When dead, their bodies were still dragged along till they were torn to pieces, or so disfigured that they could not be distinguished if at length recovered by their friends. Those who strayed out of the city to breathe the purer air of the country, or the strangers who incautiously entered the walls to visit and relieve their friends, were treated in the same way, and beaten with clubs till they were dead. The quays were watched, and, on the landing of a Jewish vessel, the merchandise was plundered, the owners and their vessel burned. Their houses were likewise set on fire, and whole families, men, women, and children, burned alive. Yet even this was a merciful death, compared with the sufferings of others. Sometimes, from want of wood, their persecutors could collect only a few wet sticks, and over these, stifled with smoke, and half-consumed, the miserable victims slowly expired. Sometimes they would mock their sufferings by affected sorrow; but if any of their own relatives or friends betrayed the least emotion, they were seized, scourged, tortured, or even crucified."

When these outrages had reached their height, Flaccus summoned before his tribunal, not the perpetrators, but the victims; and thirty-eight of the chiefs of the Alexandrian Sanhedrin were publicly scourged in the theatre, many dying under the blows. The survivors were cast into prison; and many other Jews were seized and crucified. "It was the morning spectacle of the theatre, to see the Jews scourged, tortured both with the rack and with pul-

leys, and then led away to execution; and after this horrible tragedy immediately followed farces and dances, and other theatrical amusements." All this time Flaccus was keeping back a loyal address, which the Alexandrian Jews had drawn up by the advice of Agrippa, who, discovering the fraud, sent a copy to the emperor. A centurion was sent to arrest Flaccus. He was banished, and after enduring much suffering and contempt in exile was at length put to a cruel death.

17. *Philo heads mission to Caligula to defend Jews.*

The preceding narrative, so strikingly illustrative of the condition of one branch of the Hebrew race, is furnished by Philo, the celebrated Alexandrian Jew, who brought the philosophic principles of Neo-Platonism to the defense of the ancient faith. If he may be reasonably suspected of exaggerating the sufferings and especially the submissive temper of his countrymen, there seems no reason for doubting his graphic account of the mission which he headed to Caligula, to whom the Greeks also sent a deputation headed by Apion, a name celebrated by Josephus's refutation of his book against the Jews. They arrived just at the time when Caligula, incensed at the destruction of an altar which one of the Roman *publicani* had erected to the emperor at Jamnia, had issued the edict for the erection of his own colossal statue in the Holy of Holies, and the dedication of the Temple to himself in the character of Jupiter; and this blow at the chief sanctuary of their religion seemed fatal to their own cause. Nevertheless Caligula received them with a favor, of which it soon appeared that contempt was the chief element. The celebrated interview narrated by Philo exhibits probably the prevalent feeling of the Romans toward the Jews, though distorted into peculiar grotesqueness by the emperor's insane levity. It is thus related by the eloquent historian of

the Jews:—"After a long and wearisome attendance, the deputies were summoned to a final audience. To judge so grave a cause, as Philo complains with great solemnity, the emperor did not appear in a public court, encircled by the wisest of his senators; the embassy was received in the apartments of two contiguous villas in the neighborhood of Rome, called after Lamia and Mæcenas. The bailiffs of these villas were commanded at the same time to have all the rooms thrown open for the emperor's inspection. The Jews entered, made a profound obeisance, and saluted Caligula as Augustus and Emperor—but the sarcastic smile on the face of Caligula gave them little hopes of success. 'You are then'—he said, showing his teeth as he spoke—'those enemies of the gods, who alone refuse to acknowledge my divinity, but worship a deity whose name you dare not pronounce'—and here, to the horror of the Jews, he uttered the awful name. The Greek deputies from Alexandria who were present thought themselves certain of their triumph, and began to show their exultation by insulting gestures; and Isidore, one of the accusers of Flaccus, came forward to aggravate the disobedience of the Jews. He accused them of being the only nation who had refused to sacrifice to the emperor. The Jews with one voice disclaimed the calumny, and asserted that they had three times offered sacrifice for the welfare of the emperor—and indeed had been the first to do so on his accession. 'Be it so,' rejoined the emperor—'ye have sacrificed *for* me, but not *to* me.' The Jews stood aghast and trembling. Of a sudden Caius began to run all over the house, up stairs and down stairs; inspecting the men's and women's apartment; finding fault and giving orders, while the poor Jews followed him from room to room, amid the mockery of the attendants. After he had given his orders, the emperor suddenly turned round to them: 'Why is it that you do not eat pork?' The whole court

burst into peals of laughter. The Jews temperately replied, that different nations had different usages: some persons would not eat lamb. 'They are right,' said the emperor, 'it is an insipid meat.' After further trial of their patience, he demanded, with his usual abruptness, on what they grounded their right of citizenship. They began a long and grave legal argument; but they had not proceeded far, when Caligula began to run up and down the great hall, and to order that some blinds of a kind of transparent stone like glass which admitted the light and excluded the heat and air should be put up against the windows. As he left that room, he asked the Jews, with a more courteous air, if they had anything to say to him; they began again their harangue, in the middle of which he started away into another chamber, to see some old paintings. The ambassadors of the Jews at length were glad to retreat, and felt happy to escape with their lives. Caligula gave them their dismissal in these words:—'Well, after all, they do not seem so bad; but rather a poor foolish people, who can not believe that I am a god.'"

18. *Resistance to Caligula in Judea; his decree suspended; his death.*

Whatever the Alexandrian Jews may have gained from the contemptuous forbearance and mad humor of Caligula, there was no relenting of his purpose to desecrate the temple at Jerusalem; and he directed two legions to be withdrawn from the Euphrates, if necessary, to put down resistance. Petronius reluctantly ordered the statue to be made by Sidonian workmen, while he communicated his master's intentions to the Jews. The news had no sooner spread, than the people, without distinction of rank, age, or sex, flocked in thousands, though unarmed, to the winter-quarters of the governor at Ptolemais, to let him know that

they dreaded the wrath of God more than that of the emperor. The like scene was repeated, when Petronius removed his head-quarters to Tiberias, to gain more certain information of the state of the country. When he replied to their supplications by asking them, "Are ye resolved, then, to wage war against your emperor?" they all fell on their faces to the earth, exclaiming, "We have no thought of war, but we will submit to be massacred rather than infringe our Law." For forty days they remained as suppliants before the prefect, neglecting the season for sowing, till he became alarmed lest a famine should drive the people to robbery. Petronius announced to an assembly convened at Tiberias his resolution to postpone the work till he had further orders from Rome. The influence of Agrippa with Caligula obtained the suspension of the decree; and the tyrant was preparing to vent his mortification upon Petronius, when the dagger of Cassius Chærea delivered the empire from the daily dread of some new excess of madness (A.D. 41).

19. *Herod Agrippa I made king of Judea.*

When the body of Caligula was left by his assassins in the dark corridor between the palace and the amphitheatre, the only man who protected it from insult was the Jewish prince, whose name has been more than once mentioned. This was HEROD AGRIPPA I.,²⁴ the son of Aristobulus and Berenice, and grandson of Herod the Great. He was sent to Rome on his father's execution and was brought up with Drusus the son of Tiberius. On the death of Drusus, he found himself excluded from the emperor's presence, and was besides overwhelmed with debt. Returning to Palestine, he obtained through his sister Herodias the protection of Herod Antipas who made him governor of Tiberias. But a quarrel soon took place, and after strange vicissitudes

24. The "king Herod" of Acts xii and the Agrippa I. of Josephus.

and adventures, Agrippa obtained a loan from the Alabarch of Alexandria which enabled him to return to Italy. He attached himself to the young Caius (Caligula), and having been overheard to express a hope for his friend's speedy succession, he was thrown into prison by Tiberius, where he remained till the accession of Caligula, A.D. 37. The new emperor gave him the governments formerly held by the tetrarchs Philip and Lysanias,²⁵ and bestowed on him the ensigns of royalty and other marks of favor, and he arrived in Palestine in the following year, after visiting Alexandria. The jealousy of Herod Antipas and his wife Herodias was excited by these distinctions, and they sailed to Rome in the hope of supplanting Agrippa in the emperor's favor. As we have seen, Agrippa was aware of their design, and anticipated it by a counter-charge against Antipas of treasonable correspondence with the Parthians. Antipas failed to answer the accusation, and was banished to Gaul (A.D. 39), and his dominions were added to those already held by Agrippa.

During the brief wild reign of Caligula, Agrippa continued his faithful friend, and used his influence, as we have seen, on behalf of the Jews. Having paid the last honors to his patron's remains, he smoothed the path of his successor to the throne by his activity and discretion in carrying messages between the Senate and the prætorian camp. CLAUDIUS rewarded him with the kingdom of Judæa and Samaria, in addition to his tetrarchy, and thus the dominions of Herod the Great were reunited under his grandson (A.D. 41). We must doubtless ascribe to the emperor's philosophic spirit, as well as to his favor for Agrippa, his edict for the toleration of the Jewish religion, the reality of which was proved by the punishment inflicted

25. Lysanias was a native prince, tetrarch of Abilene, the district round Abila, on the east slope of the Anti-Lebanon mountains.

by Petronius on the inhabitants of Dora for insulting a Jewish synagogue.

20. *Agrippa I favors the Jews.*

Agrippa arrived in Palestine to take possession of his kingdom, and one of his first acts was to visit the Temple, where he offered sacrifice, and dedicated the golden chain which the late emperor had presented him after his release from captivity. It was hung over the Treasury. Simon was made high-priest; and the house-tax was remitted. Unlike the other princes of his family, Agrippa was a strict observer of the Law, and he sought with success the favor of the Jews. He resided very much at Jerusalem, and added materially to its prosperity and convenience. His desire to please the Jews is indicated in Acts 12:3.

21. *Agrippa fortifies Jerusalem.*

The city had for some time been extending itself toward the north, and a large suburb had come into existence on the high ground north of the Temple, and outside the "second wall" which enclosed the northern part of the great central valley of the city. Hitherto the outer portion of this suburb—which was called Bezetha, or "New town," and had grown up very rapidly—was unprotected by any formal wall, and practically lay open to attack.²⁶ This defenseless condition attracted the attention of Agrippa, who, like the first Herod, was a great builder, and he commenced enclosing it in so substantial and magnificent a manner as to excite the suspicions of the prefect of Syria, Vibius Marsus, at whose instance the work was stopped by Claudius.²⁷ Subsequently the Jews seem to have purchased

26. The statements of Josephus are not quite reconcilable. In one passage he says distinctly that Bezetha lay quite naked (*Wars* v. 4, 2), in another that it had some kind of wall (*Ant.* xix. 7, 2).

27. Josephus, *Wars* ii, 11, 6; v. 4, 2.

permission to complete the work. This new wall, the outermost of the three which enclosed the city on the north, started from the old wall at the Tower Hippicus, near the N.W. corner of the city. It ran northward, bending by a large circuit to the east, and at last returning southward along the western brink of the valley of Kedron, till it joined the southern wall of the Temple. Thus it enclosed not only the new suburb, but also the district immediately north and north-east of the Temple on the brow of the Kedron valley, which up to the present date had lain open to the country.

22. *Agrippa kills apostle James.*

The year 44 began with the murder of St. James by Agrippa (Acts 12:1), a deed expressly ascribed to his desire to please the Jews, followed at the Passover by the imprisonment and escape of St. Peter. The exercise of the power of life and death shows that, though Agrippa's power was entirely dependent on the emperor's pleasure, it could scarcely be called nominal; but Josephus expressly calls it an illegal assumption of a power that belonged only to the Roman procurator. It was, in fact, the systematic policy of Claudius to govern those parts of the East, which had not yet been fully incorporated into the Empire, through their own petty princes.

23. *Magnificence of Agrippa I; his horrible death.*

Nature had secured for Agrippa the inheritance of at least one part of the greatness of Solomon. Now, as then, the maritime cities of Phœnicia depended for their grain upon the produce of the fertile plain districts of Palestine:—"Their country was nourished by the king's country" (Acts 12:20). The vast influence which he thus exerted is proved by the humility with which the

Tyrians and Sidonians deprecated his resentment; and the pomp amid which he received their envoys at Cæsarea, indicating a desire to assume all the greatness of his grandfather, only made the likeness of their deaths the more conspicuous.

In the fourth year of his reign over the whole of Judæa (A.D. 44) Agrippa celebrated some games at Cæsarea in honor of the emperor. When he appeared in the theatre on the second day in a royal robe made entirely of silver stuff, which shone in the morning light, his flatterers saluted him as a god; and suddenly he was seized with terrible pains, and being carried from the theatre to the palace, died after five days' agony a loathsome death, like those of the great persecutors, Antiochus Epiphanes, and his own grandfather. "After being racked for five days with intestine pains," "he was eaten of worms, and gave up the ghost." (A.D. 44.)²⁸ The miraculous and judicial character of his death is distinctly affirmed by the sacred historian:—"Immediately the *angel of the Lord* smote him, because he gave not GOD the glory." The Greeks of Sebaste and Cæsarea, with his own soldiers, showed brutal exultation at his death, and the censure which the riot brought down from Claudius upon the Roman soldiers embittered their feelings toward the Jews to such a degree, that Josephus regards this as one of the chief causes of the Jewish war.

24. *Career of Herod Agrippa II.*

HEROD AGRIPPA II.,²⁹ the son of Herod Agrippa I., was at Rome when his father died. He was only seventeen years old, and Claudius made his youth a reason for not giving him his father's kingdom, as he had intended.³⁰ The

28. Josephus, *Ant.* xix, 8, 2; Acts 12:23.

29. Called "Agrippa" by Josephus, and "King Agrippa" in Acts 25, 26, as a title of honor.

30. Josephus, *Ant.* xix, 9, 1-2.

emperor afterward gave him the kingdom of Chalcis (A.D. 50), which was vacant by the death of his uncle Herod (A.D. 48), and this was soon exchanged for the tetrarchies of Ituræa and Abilene, to which Nero added certain cities of the Decapolis about the Lake of Galilee (A.D. 52). But beyond the limits of his own dominions, Agrippa was permitted to exercise throughout Judæa that influence which even Paul recognized as welcome to a Jew, who saw in him the last scion of the Asmonæan house. In particular, he succeeded to those (as we should now say) ecclesiastical functions which the tolerant policy of Rome had permitted his uncle Herod to exercise—the government of the Temple and the nomination of the high-priest. He was, as we learn from the same authority, “expert in all customs and questions which are among the Jews;” and so well able to understand the Jewish Scriptures, that the Apostle’s reasonings from them called forth his memorable confession, “Almost thou persuadest me to be a Christian.” (Acts 26:3, 26-28). He gratified his hereditary taste for magnificence by adorning Jerusalem and Berytus with costly buildings; but in such a manner as mortally to offend the Jews;³¹ and his relations to his sister Berenice (or Bernice), the widow of his uncle Herod, were of a very doubtful character. But his one leading principle was to preserve fidelity to Rome. His sister, Drusilla, was married to Felix, the procurator of Judæa under Claudius and Nero; and the narrative of St. Paul’s trial shows Agrippa’s intimacy with Festus, the successor of Felix (Acts 26:24-27). In the last great rebellion of Judæa, he took part with Rome. With the destruction of Jerusalem (A.D. 70), an end was put to this last Jewish principality. Retaining, however, his empty title as king, Agrippa survived the fate of his country in the enjoyment of splendid luxury, retired to

31. Josephus, *Ant.* xx. 7, 8.

Rome with Berenice, and died there in the third year of Trajan (A.D. 100).

25. *Judea again under procurators: (1) Fadus.*

Shortly after the death of Herod Agrippa I., CUSPIUS FADUS arrived from Rome as procurator, under Longinus as prefect of Syria. An attempt was made by the Romans to regain possession of the pontifical robes; but on reference to the emperor the attempt was abandoned.

26. *Famine in Judea; Queen Helena; Paul and Barnabas visit Jerusalem.*

In A.D. 45 commenced a severe famine, which lasted two years. To the people of Jerusalem it was alleviated by the presence of Helena, queen of Adiabene, a convert to the Jewish faith, who visited the city in 46 and imported corn and dried fruit, which she distributed to the poor.⁸² During her stay Helena constructed at a distance of three stadia from the city a tomb marked by three pyramids, to which her remains, with those of her son were afterward brought. It was situated to the north and formed one of the points in the course of the new wall.

The tomb of Helena which includes burial niches for many members of her family is often wrongly called "The Tombs of the Kings." It lies just north of Jerusalem.

This famine furnishes one of the chief data of the chronology of the Acts in the journey of Paul and Barnabas bringing the contributions for the poor Christians at Jerusalem which had been collected at Antioch in consequence of the prediction of the famine by Agabus (Acts 11:28-30).

82. Josephus, *Ant.* xx, 2, 5; xx, 5, 2.

27. *Procurators (8) Alexander, and (9) Cumanus; tumult at the Passover.*

Fadus was succeeded by TIBERIUS ALEXANDER, an apostate Egyptian Jew (A.D. 46), and he by VENTIDIUS CUMANUS (A.D. 48 or 50). A frightful tumult happened at the Passover of this year, caused, as on former occasions, by the presence of the Roman soldiers in the Antonia, and in the courts and cloisters of the Temple, during the festival. Ten, or, according to another account, twenty thousand are said to have met their deaths, not by the sword, but trodden to death in the crush through the narrow lanes which led from the Temple down into the city.³³ After other outrages, Cumanus was recalled to Rome where Agrippa's influence procured his banishment (A.D. 53), and FELIX was appointed in his room,³⁴ partly at the urging of Jonathan, the then high-priest. The hatred of Claudius to "foreign superstition" had meanwhile been vented in an edict banishing the Jews from Rome (A.D. 52).

28. *Cruel procuratorship of (10) Felix.*

Felix ruled the province in a mean, cruel, and profligate manner. With the compendious description of Tacitus the fuller details of Josephus agree, though his narrative is tinged with his hostility to the Jewish patriots and zealots, whom, under the name of robbers, he describes Felix as extirpating and crucifying by hundreds. His period of office was full of troubles and seditions. We read of his putting down false Messiahs, the followers of an Egyptian magician, riots between the Jews and Syrians in Cæsarea, and between the priests and the principal citizens of Jerusalem. A set of ferocious fanatics, whom Josephus calls *Sicarii* (Assassins), had lately begun to make their appear-

33. Josephus, *Ant.* xx, 2, 5; *Wars*, xx, 12, 1.

34. Josephus, *Ant.* xx, 7, 1.

ance in the city, whose creed it was to rob and murder all whom they judged hostile to Jewish interests. Felix, weary of the remonstrances of Jonathan (the priest) on his vicious life, employed some of these wretches to assassinate him. The high-priest was killed in the Temple, while sacrificing. The murder was never inquired into, and emboldened by this, the Sicarii repeated their horrid act; thus adding, in the eyes of the Jews, the awful crime of sacrilege to that of murder.⁸⁵ The city, too, was filled with impostors pretending to inspiration, (cf. Mark 13:6), but inspired only with hatred to all government and order. Nor was the disorder confined to the lower classes: the chief people of the city, the very high-priests themselves, robbed the threshing-floors of the tithes common to all the priests, and led parties of rioters to open tumult and fighting in the streets.⁸⁶ In fact, not only Jerusalem, but the whole country far and wide, was in the most frightful confusion and insecurity, and, though want of vigor was not among the faults of Felix, his severe measures and cruel retributions seemed only to accelerate the already rapid course of the Jews to ruin. His detention of St. Paul in prison, in the hope of extorting money, adds to the traits of tyranny the baseness of the freedman. Tacitus says, in one word, "By every form of cruelty and lust, he wielded the power of a king in the spirit of a slave." Such were the crimes that weighed on the conscience of the Apostle's judge—dreading the vengeance of his earthly master, while he had learned something of higher principles from his Jewish wife, Drusilla. No wonder that, as Paul "reasoned of righteousness, temperance, and *judgment to come*, Felix trembled" (Acts 24:25). His crowning outrage was a massacre of the Jews at Cæsarea, on the occasion of one of their frequent conflicts with the Greeks. For this he was accused before

⁸⁵ Josephus, *Wars*, ii, 13, 3.

⁸⁶ J., *Ant.* xx, 8, 8.

Nero, after his recall (A.D. 60); but the party of his brother Pallas had still influence enough to save him from punishment; while the Greeks of Cæsarea obtained an imperial decree depriving the Jewish citizens of their rights. These affairs of Cæsarea hastened the coming contest: the Greeks became more and more insulting; the Jews more and more turbulent.

29. *Able, upright* (11) *Festus*.

In the end of A.D. 60 or the beginning of A.D. 61, PORCIUS FESTUS succeeded Felix as procurator. Festus was an able and upright officer,³⁷ and at the same time conciliatory toward the Jews, as he proved in his judgment on St. Paul, whose trial took place, not at Jerusalem, but at Cæsarea. (Acts 25, 26). In the brief period of his administration, he kept down the robbers with a strong hand, and gave the province a short breathing time. On one occasion both Festus and Agrippa came into collision with the Jews at Jerusalem. Agrippa had added an apartment to the old Asmonæan palace on the eastern brow of the Upper City, which commanded a full view into the interior of the courts of the Temple. This view the Jews intercepted by building a wall on the west side of the inner quadrangle.³⁸ But the wall not only intercepted Agrippa's view, it also interfered with that from the outer cloisters, in which the Roman guard was stationed during the festivals. Both Agrippa and Festus interfered and required it to be pulled down; but the Jews pleaded that, once built, it was a part of the Temple, and entreated to be allowed to appeal to Nero. Nero allowed their plea, but retained as hostages the high-priest and treasurer, who had headed the deputa-

37. J., *Wars*, ii, 14, 1.

38. No one in Jerusalem might build so high that his house could overlook the Temple. It was the subject of a distinct prohibition by the Rabbis. Probably this furnished one reason for so hostile a step to so friendly a person as Agrippa.

tion. Agrippa appointed Joseph, called Cabi, to the vacant priesthood, in which he was shortly after succeeded by ANNAS or ANANUS, the fifth son of the Annas before whom our Lord was taken.

30. *Procurator (12) Albinus; increasing bloodshed throughout the land.*

In 62 (probably) Festus died, and was succeeded after a time by ALBINUS. In the interval a persecution was commenced against the Christians at the instance of Ananus, the new high-priest, a rigid Sadducee, and St. James (the brother of Christ) and others were arranged before the Sanhedrin.³⁹ They were "delivered to be stoned," but St. James at any rate appears not to have been killed till a few years later. The act gave great offense to all and cost Ananus his office after he had held it but three months. Jesus (Joshua), the son of Daemneus, succeeded him. Albinus began his rule by endeavoring to keep down the Sicarii and other disturbers of the peace; and indeed he preserved throughout a show of justice and vigor,⁴⁰ though in secret greedy and rapacious. But before his recall he pursued his end more openly, and priests, people, and governors alike seem to have been bent on rapine and bloodshed: rival high-priests headed bodies of rioters, and stoned each other, and in the words of Josephus, "all things grew from worse to worse."⁴¹ The evils were aggravated by two occurrences—first, the release by Albinus, before his departure, of all the smaller criminals in the prisons; and secondly, the sudden discharge of an immense body of workmen, on the completion of the repairs of the Temple. An endeavor was made to remedy the latter by inducing Agrippa to rebuild the eastern cloister; but he refused to

39. *J. Ant.* xx, 9, 1.

40. *J., Ant.* xx, 11, 1.

41. *J., Ant.* xx, 9, 4.

undertake a work of such magnitude, though he consented to pave the city with marble. The repairs of a part of the sanctuary that had fallen down, and the renewal of the foundations of some portions, were deferred for the present, but the materials were collected and stored in one of the courts.⁴²

31. *Last and worst procurator, (13) G. Florus.*

Bad as Albinus had been, GESSIUS FLORUS, who succeeded him in A.D. 65, was worse. In fact, even Tacitus admits that the endurance of the oppressed Jews could last no longer. So great was his rapacity, that whole cities and districts were desolated, and the robbers were openly allowed to purchase immunity in plundering. At the Passover, probably in 66, when Cestius Gallus, the prefect of Syria, visited Jerusalem, the whole assembled people⁴³ besought him for redress; but without effect. Florus's next attempt was to obtain some of the treasure from the Temple. He demanded seventeen talents in the name of the emperor. The demand produced a frantic disturbance, in the midst of which he approached the city with both cavalry and foot-soldiers. That night Florus took up his quarters in the royal palace—that of Herod at the N.W. corner of the city. On the following morning he took his seat on the Bema, and the high-priest and other principal people being brought before him, he demanded that the leaders of the late riot should be given up. On their refusal, he ordered his soldiers to plunder the Upper City. This order was but too faithfully carried out; every house was entered and pillaged, and the Jews driven out. In their attempt to get through the narrow streets, which lay in the valley between the Upper City and the Temple, many were caught and slain, others were brought before

42. *J. Wars*, v, 1, 5.

43. Josephus says three million in number!

Florus, scourged, and then crucified. No grade or class was exempt. Jews who bore the Roman equestrian order were among the victims treated with most indignity. Queen Bernice herself—residing at that time in the Asmonæan palace in the very midst of the slaughter—was so affected by the scene, as to intercede in person and bare-foot before Florus, but without avail; and in returning she was herself nearly killed, and only escaped by taking refuge in her palace and calling her guards about her. The further details of this dreadful tumult must be passed over. Florus was foiled in his attempt to press through the old city up into the Antonia—whence he would have had nearer access to the treasures—and finding that the Jews had broken down the north and west cloisters where they joined the fortress, so as to cut off the communication, he relinquished the attempt and withdrew to Cæsarea.⁴⁴

32. *Outbreak of Jewish revolt against the Romans.*

Cestius Gallus, the prefect of Syria, now found it necessary for him to visit the city in person. He sent one of his lieutenants to announce him, but before he himself arrived events had become past remedy. Agrippa had shortly before returned from Alexandria, and had done much to calm the people. At his suggestion they rebuilt the part of the cloister which had been demolished, and collected the tribute in arrear, but the mere suggestion from him, that they should obey Florus until he was replaced, produced such a storm that he was obliged to leave the city. The seditious party in the Temple, led by young Eleazar, son of Ananias, rejected the sacrifices of the Roman emperor, which had been regularly made since the time of Julius Cæsar. *This, as a direct renunciation of allegiance, was the true beginning of the war with Rome.*⁴⁵

44. J., *Wars*, ii, 15, 6.

45. J., *Wars*, ii, 17, 2.

Such acts were not done without resistance from the older and wiser people. But remonstrance was unavailing, the innovators would listen to no representations. The peace party, therefore, dispatched some of their number to Florus and to Agrippa, and the latter sent 3000 horse-soldiers to assist in keeping order.

33. *Initial victories of the Jews.*

Hostilities at once began. The peace party, headed by the high-priest, and fortified by Agrippa's soldiers, threw themselves into the Upper City. The insurgents held the Temple and the Lower City. In the Antonia was a small Roman garrison. Fierce contests lasted for seven days, each side endeavoring to take possession of the part held by the other. At last the insurgents, who behaved with the greatest ferocity, and were reinforced by a number of Sicarii, were triumphant. They gained the Upper City, driving all before them—the high-priest and other leaders into vaults and sewers, the soldiers into Herod's palace. The Asmonæan palace, the high-priest's house, and the repository of the archives—in Josephus's language, "the nerves of the city"—were set on fire. Antonia was next attacked, and in two days they had effected an entrance, sabred the garrison, and burned the fortress. The balistæ and catapults found there were preserved for future use. The soldiers in Herod's palace were next besieged; but so strong were the walls, and so stout the resistance, that it was three weeks before an entrance could be effected. The soldiers were at last forced from the palace into the three great towers on the adjoining wall with great loss; and ultimately were all murdered in the most treacherous manner. The high-priest and his brother were discovered hidden in the aqueduct of the palace: they were instantly put to death. Thus the insurgents were now completely masters of both city and Temple. But they were not to

remain so long. After the defeat of Cestius Gallus at Beth-horon, dissensions began to arise, and it soon became known that there was still a large moderate party; and Cestius took advantage of this to advance from Scopus on the city. He made his way through Bezetha, the new suburb north of the Temple,⁴⁶ and through the wood-market, burning every thing as he went,⁴⁷ and at last encamped opposite the palace at the foot of the second wall. The Jews retired to the Upper City and to the Temple. For five days Cestius assaulted the wall without success; on the sixth he resolved to make one more attempt, this time in a different spot—the north wall of the Temple, east of, and behind, the Antonia. The Jews, however, fought with such fury from the top of the cloisters, that he could effect nothing, and when night came he drew off to his camp at Scopus. Thither the insurgents followed him, and in three days gave him one of the most complete defeats that a Roman army had ever undergone. His catapults and balistæ were taken from him, and reserved by the Jews for the final siege. This occurred on the 8th of Marchesvan (beginning of November), A.D. 66.

34. *Principal men of the war.*

The war with Rome was now inevitable, and Nero, who received the news in Greece, committed its conduct to his ablest general, T. FLAVIUS VESPASIANUS (afterward the emperor), who sent his son TITUS before him. It was evident that the siege of Jerusalem was only a question of time. Ananus, the high-priest, a moderate and prudent man, took the lead; the walls were repaired, arms and war-like instruments and machines of all kinds fabricated, and other preparations made. In this attitude of expectation—

46. It is remarkable that nothing is said of any resistance to his passage through the great wall of Agrippa which encircled Bezetha.

47. J., *Wars*, v, 7, 2.

with occasional diversions, such as the expedition to Ascalon, and the skirmishes with Simon Bar-Gioras—the city remained, while Vespasian was reducing the north of the country, and till the fall of Giscala (Oct. or Nov. 67), when JOHN, the son of Levi, escaped thence to Jerusalem, to become one of the most prominent persons in the future conflict. Nor must we omit to mention here John's great rival, Joseph, the son of Matthias, who is best known by his adopted Roman name of FLAVIUS JOSEPHUS, the historian of the Jews and of this war. A priest of the most illustrious descent, distinguished alike for his ascetic piety and his Hebrew and Greek learning, he was appointed by the moderate party to defend Galilee and keep down the zealots. His energy in the latter task made him a mortal enemy of John of Giscala, while his brilliant though vain defense of Jotapata, before which Vespasian himself was wounded, earned him the respect of the Roman chief, who attached him to his person during the war, used his services as a mediator, though to no purpose, and at last rewarded him with a grant of land in Judæa, a pension, and the Roman franchise. For the details of the war Josephus is our only authority, most unfortunately; for, besides the natural bias toward pleasing his imperial patrons, his sense of the hopelessness of the Jewish cause overcame all patriotic sympathy with resistance to intolerable oppression, and personal animosity leads him to paint the zealots in the blackest colors.

34. *Romans conquer whole country; temporary suspension of the siege of Jerusalem.*

From the arrival of John, two years and a half elapsed till Titus appeared before the walls of Jerusalem, which now stood alone like a rock out of the flood of conquest that had overwhelmed all the country. While Vespasian reduced Galilee—the Samaritans, who, making common

cause with the Jews in their extremity, had gathered their whole force on Mount Gerizim, and, being compelled by thirst to surrender to Petilius Cerealis, were treacherously massacred—Trajan, the father of the emperor, took Jamnia, the frontier fortress of Judæa, and Joppa, its only port (A.D. 67). In the second campaign the Romans swept Peræa, and multitudes of the flying inhabitants were slaughtered and drowned at the fords of Jericho. Vespasian had reunited his forces at that city, and was preparing to advance upon Jerusalem, when the news of Nero's death suspended his operations, upon what seemed to him a higher issue than the fate of the Holy City (A.D. 68). At Alexandria, whither he had retired with Titus to await the event of the civil war in Italy, he was proclaimed emperor by his soldiers on the 1st of July, A.D. 69, and his generals at Rome secured his accession by the overthrow and death of Vitellius on the 21st of December. Vespasian did not sail from Alexandria till the following May, leaving Titus to finish the Jewish war, which had been suspended for nearly two years.

It should be added here, that the Christians in Jerusalem were saved by their Lord's warning from the blindness of their fellow-countrymen (Luke 21:20-24). Taking advantage of the space before the siege was formed by Titus, they departed in a body to Pella, a village of the Decapolis beyond Jordan, which became the seat of the "Church of Jerusalem" till Hadrian permitted their return.

The entire time of the suspension of the war was occupied in contests between the moderate party, whose desire was to take such a course as might yet preserve the nationality of the Jews and the existence of the city, and the Zealots or fanatics, the assertors of national independence, who scouted the idea of compromise, and resolved to regain their freedom or perish. The Zealots, being ut-

terly unscrupulous and resorting to massacre on the least resistance, soon triumphed, and at last reigned paramount, with no resistance but such as sprang from their own internal factions. For the repulsive details of this frightful period of contention and outrage the reader must be referred to other works.⁴⁸ It will be sufficient to say that at the beginning of A.D. 70, when Titus made his appearance, the Zealots themselves were divided into two parties: that of John of Giscala and Eleazar, who held the Temple and its courts and the Antonia—8400 men; that of Simon Bar-Gioras, whose head-quarters were in the tower of Phasaelus, and who held the Upper City, from the present Cœnaculum (place of the Last Supper) to the Latin Convent, the Lower City in the valley, and the district where the old Acra had formerly stood, north of the Temple—10,000 men, and 5000 Idumæans, in all a force of between 23,000 and 24,000 soldiers, trained in the civil encounters of the last two years to great skill and thorough recklessness.⁴⁹ The numbers of the other inhabitants, swelled as they were by the strangers and pilgrims who flocked from the country to the Passover, it is extremely difficult to determine. Tacitus, doubtless from some Roman source, gives the whole at 600,000. Josephus states that 1,100,000 perished during the siege,⁵⁰ and that more than 40,000 were allowed to depart into the country, in addition to an "immense number" sold to the army, and who of course form a proportion of the 97,000 "carried captive during the whole war." We may therefore take Josephus's computation of the numbers at about 1,200,000. Even the smaller of these numbers seems very greatly in excess, and it may well have been nearer 60,000 or 70,000.

48. Of course the materials for all modern accounts are in Josephus only, excepting the few touches—strong, but not always accurate—in the 5th book of Tacitus' *Histories*.

49. These are the numbers given by Josephus; but it is probable that they are exaggerated.

50. *Wars*, vi, 9, 3.

This state of the doomed city,—overcrowded with Jews, whose native passions and fervor, exasperated by the late war and exalted by the season of the Passover, doomed to be their last, were stimulated by the Zealots and inflamed by factions,—might well prepare those who knew the people for horrid deeds and more horrid sufferings. Pent up like sheep for the slaughter, they equally resembled wolves devouring one another. But the scene had a far more awful aspect, viewed in the light of ancient prophecy, as well as Christ's recent denunciations of woe. As they who rejected him did but "fill up the measure of their fathers," so the warnings uttered to those fathers by Moses, by Solomon, and by the prophets, were but made more pointed and more instant in our Lord's discourse at his last departure from the Temple (Matt. 24).

35. *Titus' siege of Jerusalem.*

Titus's force consisted of four legions, and some auxiliaries—at the outside 30,000 men. These were disposed on their first arrival in three camps—the 12th and 15th legions on the ridge of Scopus, about a mile north of the city; the 5th a little in the rear; and the 10th on the top of the Mount of Olives, to guard the road to the Jordan valley, and to shell the place (if the expression may be allowed) from that commanding position. The army was well furnished with artillery and machines of the latest and most approved invention. The first operation was to clear the ground between Scopus and the north wall of the city—fell the timber, destroy the fences of the gardens which fringed the wall, and level the rocky protuberances. This occupied four days. After it was done, the three legions were marched forward from Scopus, and encamped off the north-west corner of the walls, stretching from the Tower Psephinus to opposite Hippicus. The first step was to get possession of the outer wall. The point of attack

chosen was in Simon's portion of the city, at a low and comparatively weak place near the monument of John Hyrcanus, close to the junction of the three walls, and where the Upper City came to a level with the surrounding ground. Round this spot the three legions erected banks, from which they opened batteries, pushing up the rams and other engines of attack to the foot of the wall. One of the rams, more powerful than the rest, went among the Jews by the nickname of *Nikon*, the conqueror. Three large towers, 75 feet high, were also erected, overtopping the wall. Meantime from their camp on the Mount of Olives the 10th legion opened fire on the Temple and the east side of the city. They had the heaviest balistæ, and did great damage. Simon and his men did not suffer these works to go on without molestation. The catapults, both those taken from Cestius, and those found in Antonia, were set up on the wall, and constant desperate sallies were made. At last the Jews began to tire of their fruitless assaults. They saw that the wall must fall, and, as they had done during Nebuchadnezzar's siege, they left their posts at night, and went home. A breach was made by the redoubtable Nikon on the 7th Artemisius (about April 15); and here the Romans entered, driving the Jews before them to the second wall. A great length of the wall was then broken down; such parts of Bezetha as had escaped destruction by Cestius were leveled, and a new camp was formed on the spot formerly occupied by the Assyrians, and still known as the "Assyrian camp."

This was a great step in advance. Titus now lay with the second wall of the city close to him on his right, while before him at no considerable distance rose Antonia and the Temple, with no obstacle in the interval to his attack. Still, however, he preferred, before advancing, to get possession of the second wall, and the neighborhood of John's monument was again chosen. Simon was no less

reckless in assault, and no less fertile in stratagem, than before; but notwithstanding all his efforts, in five days a breach was again effected. The district into which the Romans had now penetrated was the great Valley which lay between the two main hills of the city, occupied then, as it is still, by an intricate mass of narrow and tortuous lanes, and containing the markets of the city—no doubt very like the present bazaars. Titus's breach was where the wool, cloth, and brass bazaars came up to the wall. This district was held by the Jews with the greatest tenacity. Knowing as they did every turn of the lanes and alleys, they had an immense advantage over the Romans, and it was only after four days' incessant fighting, much loss, and one thorough repulse, that the Romans were able to make good their position. However, at last, Simon was obliged to retreat, and then Titus demolished the wall. This was the second step in the siege.

Meantime some shots had been interchanged in the direction of the Antonia, but no serious attack was made. Before beginning there in earnest, Titus resolved to give his troops a few days' rest, and the Jews a short opportunity for reflection. He therefore called in the 10th legion from the Mount of Olives, and held an inspection of the whole army on the ground north of the Temple—full in view of both the Temple and the Upper City, every wall and house in which were crowded with spectators. But the opportunity was thrown away upon the Jews, and after four days orders were given to recommence the attack. Hitherto the assault had been almost entirely on the city: it was now to be simultaneous on city and Temple. Accordingly two pairs of large batteries were constructed, the one pair in front of Antonia; the other at the old point of attack—the monument of John Hyrcanus. The first pair was erected by the 5th and 12th legions, and was near the pool Struthius—probably the present *Pool of Israel*, by the St.

Stephen's gate; the second by the 10th and 15th, at the pool called the Almond pool—possibly that now known as the pool of Hezekiah—and near the high-priest's monument. These banks seem to have been constructed of timber and fascines, to which the Romans must have been driven by the scarcity of earth. They absorbed the incessant labor of seventeen days, and were completed on the 29th Artemisius (about May 7). John in the mean time had not been idle; he had employed the seventeen days' respite in driving tunnels, through the solid limestone of the hill, from within the fortress to below the banks. The tunnels were formed with timber roofs and supports. When the banks were quite complete, and the engines placed upon them, the timber of the galleries was fired, the superincumbent ground gave way, and the labor of the Romans was totally destroyed. At the other point Simon had maintained a resistance with all his former intrepidity, and more than his former success. He had now greatly increased the number of his machines, and his people were much more expert in handling them than before, so that he was able to impede materially the progress of the works. And when they were completed, and the battering rams had begun to make a sensible impression on the wall, he made a furious assault on them, and succeeded in firing the rams, seriously damaging the other engines, and destroying the banks.

It now became plain to Titus that some other measures for the reduction of the place must be adopted. It would appear that hitherto the southern and western parts of the city had not been invested, and on that side a certain amount of communication was kept up with the country, which, unless stopped, might prolong the siege indefinitely. The number who thus escaped is stated by Josephus at more than 500 a day. A council of war was therefore held, and it was resolved to encompass the whole place

with a wall,⁵¹ and then recommence the assault. The wall began at the Roman camp—a spot probably outside the modern north wall, between the Damascus gate and the N.E. corner; from thence it went to the lower part of Bezetha—about St. Stephen's gate; then across Kedron to the Mount of Olives; thence south, by a rock called the "Pigeon's rock,"—possibly the modern "Tombs of the Prophets"—to the Mount of Offense. It then turned to the west; again dipped into the Kedron, ascended the Mount of Evil Counsel, and so kept on the upper side of the ravine to a village called Beth-Erebenthi, whence it ran outside of Herod's monument to its starting-point at the camp. Its entire length was 39 furlongs—very near 5 miles; and it contained 13 stations or guard-houses. The whole strength of the army was employed on the work, and it was completed in the short space of three days. The siege was then vigorously pressed. The north attack was relinquished, and the whole force concentrated on the Antonia. Four new banks of greater size than before were constructed, and as all the timber in the neighborhood had been already cut down, the materials had to be procured from a distance of eleven miles. Twenty-one days were occupied in completing the banks. At length on the 1st Panemus or Tamuz (about June 7), the fire from the banks commenced, under cover of which the rams were set to work, and that night a part of the wall fell at a spot where the foundations had been weakened by the mines employed against the former attacks. Still this was but an outwork, and between it and the fortress itself a new wall was discovered, which John had taken the precaution to build. At length, after two desperate attempts, his wall and that of the inner fortress were scaled by a bold surprise, and on the 5th Panemus (June 11) the Antonia was in the hands of the Romans. Another week was occupied in the breaking down the outer

51. Luke 19:43.

walls of the fortress for the passage of the machines, and a further delay took place in erecting new banks on the fresh level for the bombardment and battery of the Temple. During the whole of this time—the miseries of which are commemorated in the traditional name of *yomin deeka*, “days of wretchedness,” applied by the Jews to the period between the 17th Tamuz and the 9th Ab—the most desperate hand-to-hand encounters took place, some in the passages from the Antonia to the cloisters, some in the cloisters themselves, the Romans endeavoring to force their way in, the Jews preventing them. But the Romans gradually gained ground. First the western, and then the whole of the northern external cloister was burned (27th and 28th Panemus), and then the wall enclosing the court of Israel and the holy house itself. In the interval, on the 17th Panemus, the daily sacrifice had failed, owing to the want of officiating priests; a circumstance which had greatly distressed the people, and was taken advantage of by Titus to make further though fruitless invitation to surrender.

36. *Burning of the Temple.*

At length, on the 10th day of Lous or Ab (July 15),—the 9th, according to the Jewish tradition—by the wanton act of a soldier, contrary to the intention of Titus and in spite of every exertion he could make to stop it, the sanctuary itself was fired. It was, by one of those rare coincidences that sometimes occur, the very same month and day of the month that the first temple had been burned by Nebuchadnezzar. John, and such of his party as escaped the flames and the carnage, made their way by the bridge on the south to the Upper City. The whole of the cloisters that had hitherto escaped, including the magnificent triple colonnade of Herod on the south of the Temple, the treasury chambers, and the rooms round the outer

courts, were now all burned and demolished. Only the edifice of the sanctuary itself still remained. On its solid masonry the fire had had comparatively little effect, and there were still hidden in its recesses a few faithful priests who had contrived to rescue the most valuable of the utensils, vessels, and spices of the sanctuary.

37. Final capture of Jerusalem.

The Temple was at last gained; but it seemed as if half the work remained to be done. The Upper City, higher than Moriah, and on all sides precipitous except at the north, where it was defended by the wall and towers of Herod, was still to be taken. Titus tried a parley first through Josephus, and then in person, he standing on the east end of the bridge between the Temple and the Upper City, and John and Simon on the west end. His terms, however, were rejected, and no alternative was left him but to force on the siege. The whole of the low part of the town—the crowded lanes, of which we have so often heard—was burned, in the teeth of a frantic resistance from the Zealots, together with the council-house, the repository of the records (doubtless occupied by Simon since its former destruction), and the palace of Helena, which were situated in this quarter—the suburb of Ophel under the south wall of the Temple, and the houses as far as Siloam on the lower slopes of the Temple mount.

It took 18 days to erect the necessary works for the siege; the four legions were once more stationed at the west or northwest corner, where Herod's palace abutted on the wall, and where the three magnificent and impregnable towers of Hippicus, Phasaelus, and Mariamne rose conspicuous. This was the main attack. Opposite the Temple, the precipitous nature of the slopes of the Upper City rendered it unlikely that any serious attempt would be made by the Jews, and this part accordingly, between

the bridge and the Xystus, was left to the auxiliaries. The attack was commenced on the 7th of Gorpiaëus (about Sept. 11), and by the next day a breach was made in the wall, and the Romans at last entered the city. During the attack John and Simon appear to have stationed themselves in the towers just alluded to; and had they remained there, they would probably have been able to make terms, as the towers were considered impregnable. But on the first signs of the breach, they took flight, and, traversing the city, descended into the valley of Hinnom below Siloam, and endeavored to force the wall of circumvallation and so make their escape. On being repulsed there, they took refuge apart in some of the subterraneous caverns or sewers of the city. John shortly after surrendered himself; but Simon held out for several weeks, and did not make his appearance until after Titus had quitted the city. They were both reserved for the triumph at Rome.

The city being taken, such parts as had escaped the former conflagrations were burned, and the whole of both city and Temple was ordered to be demolished, excepting the west wall of the Upper City, and Herod's three great towers at the north-west corner, which were left standing as memorials of the massive nature of the fortifications.

Of the Jews, the aged and infirm were killed; the children under seventeen were sold as slaves; the rest were sent, some to the Egyptian mines, some to the provincial amphitheatres, and some to grace the triumph of the Conqueror. Titus then departed, leaving the 10th legion, under the command of Terentius Rufus, to carry out the work of demolition. Of this Josephus assures us, that "the whole was so thoroughly leveled and dug up, that no one visiting it would believe that it had ever inhabited."

38. *Fall of Masada.*

Early in the revolt of the Jews (about A.D. 67), a group of fanatic Jewish rebels (Zealots) seized the rocky cliff fortress of Masada on the west side of the Dead Sea, (Josephus, *Wars*, II, 17, 2). Herod the Great had used this imposing precipice-faced fort as a retreat. The Zealots used Masada as a base for attacks against the Romans. Masada remained in Jewish hands after all other Palestinian sites had fallen to Rome. Then the Roman general Flavius Silva came and besieged Masada. Outlines of Silva's camp and fortifications can still be seen around Masada. The last defenders of Masada chose suicide rather than surrender and slavery. Josephus has a vivid account of the fall of Masada (*Wars*, VII, 8-9). It fell in A.D. 73. The fortress top was excavated in 1955-56 by the Israeli archaeologist Yigal Yadin.

39. *Jerusalem after its fall.*

The great interest belonging to Jerusalem as the central scene of Sacred History, and especially in connection with our Lord's prediction of the destruction of the Temple, seems to demand a few words by way of supplement. For more than fifty years after its destruction by Titus, Jerusalem disappears from history. During the revolts of the Jews in Cyrenaica, Egypt, Cyprus, and Mesopotamia, which disturbed the latter years of Trajan, the recovery of their city was never attempted. Of its annals during this period we know nothing. Three towers and part of the western wall alone remained of its strong fortifications to protect the cohorts who occupied the conquered city; and the soldiers' huts were long the only buildings on its site.

40. *The Bar-Cochba revolt (second Jewish revolt).*

But in the reign of Hadrian it again emerged from its obscurity and became the centre of an insurrection

which the best blood of Rome was shed to subdue. In despair of keeping the Jews in subjection by other means, the Emperor had formed a design to restore Jerusalem and thus prevent it from ever becoming a rallying point for this turbulent race. In furtherance of his plan he had sent thither a colony of veterans, in numbers sufficient for the defense of a position so strong by nature against the then known modes of attack. To this measure Dion Cassius attributes a renewal of the insurrection, while Eusebius asserts that it was not carried into execution till the outbreak was quelled. Be this as it may, the embers of revolt, long smouldering, burst into a flame soon after Hadrian's departure from the East in A.D. 132. The contemptuous indifference of the Romans, or the secrecy of their own plans, enabled the Jews to organize a widespread conspiracy. Bar-Cochba, their leader, the third, according to the Rabbinical writers, of a dynasty of the same name, princes of the captivity, was crowned king of Bether by the Jews who thronged to him, and by the populace was regarded as the Messiah. His armor-bearer, Rabbi Akiba, claimed descent from Sisera and hated the Romans with the fierce rancor of his adopted nation. All the Jews in Palestine flocked to his standard. At an early period in the revolt they became masters of Jerusalem and attempted to rebuild the Temple. Hadrian, alarmed at the rapid spread of the insurrection, and the ineffectual efforts of his troops to repress it, summoned from Britain Julius Severus, the greatest general of his time, to take the command of the army of Judæa. Two years were spent in a fierce guerrilla warfare, before Jerusalem was taken, after a desperate defense in which Bar-Cochba perished. The courage of the defenders was shaken by the falling in of the vaults on Mount Zion, and the Romans became masters of the position. But the war did not end with the capture of the city. The Jews in great force had occupied the

THE HERODS, THE JEWS, AND ROME

fortress of Bether, and there maintained a struggle with all the tenacity of despair against the repeated onsets of the Romans. At length, worn out by famine and disease, they yielded on the 9th of the month Ab, A.D. 135, and the grandson of Bar-Cochba was among the slain. The slaughter was frightful. Five hundred and eighty thousand are said to have fallen by the sword, while the number of victims to the attendant calamities of war was countless. On the side of the Romans the loss was enormous, and so dearly bought was their victory, that Hadrian, in his letter to the Senate, announcing the conclusion of the war, did not adopt the usual congratulatory phrase. Bar-Cochba has left traces of his occupation of Jerusalem in coins which were struck during the first two years of the war. Four silver coins, three of them undoubtedly belonging to Trajan, have been discovered, restamped with Samaritan characters. But the rebel leader, amply supplied with the precious metals by the contributions of his followers, afterward coined his own money. The mint was probably at Jerusalem during the first two years of the war; the coins struck during that period bearing the inscription, "To the freedom of Jerusalem," or "Jerusalem the holy."

In 1960 Israeli archaeologists found in a cave in a cliff face at Nahal Hever, about 3 1/2 miles south of En-Gedi (this is a rugged, precipitous desert), many actual remains of the Bar-Cochba revolt: coins; arrow; cloth; baskets; skulls and bones of some of Bar-Cochba's men; many writings on papyrus and wood, some from Bar-Cochba himself requesting food and other assistance; Roman cult objects apparently stolen from the Roman camp; etc.

From these discoveries it appears that Bar-Cochba depended heavily on foodstuffs produced at the oasis of En-Gedi, or shipped into En-Gedi from the other side of the Dead Sea. His troops controlled the areas around Tekoa and Bethlehem when the documents were written, and

he was somewhere about Jerusalem. When the revolt was crushed, the last survivors from the En-Gedi area went to the remote caves with the valuables that were found over 1800 years later. (See *Biblical Archaeologist*, May 1961, p. 34 ff. and Sept. 1961, p. 86 ff.)

41. *Hadrian's makes Jerusalem a pagan city.*

Hadrian's first policy, after the suppression of the revolt, was to obliterate the existence of Jerusalem as a city. The ruins which Titus had left were razed to the ground, and the plough passed over the foundations of the Temple. A colony of Roman citizens occupied the new city which rose from the ashes of Jerusalem, and their number was afterward augmented by the Emperor's veteran legionaries. A temple to the Capitoline Jupiter was erected on the site of the sacred edifice of the Jews. A temple to Astarte, the Phœnician Venus, on the site afterward identified with the Sepulchre, appears on coins, with four columns and the inscription C. A. C., *Colonia Aelia Capitolina*, but it is more doubtful whether it was erected at this time.

It was not, however, till the following year, A.D. 136, that Hadrian, on celebrating his Vicennalia, bestowed upon the new city the name AELIA CAPITOLINA, combining his own family title with the name of Jupiter of the Capital, the guardian deity of the colony. Christians and pagans alone were allowed to reside in the city. Jews were forbidden to enter it on pain of death and this prohibition remained in force in the time of Tertullian. About the middle of the 4th century the Jews were allowed to visit the neighborhood, and afterward, once a year, to enter the city itself, and weep over it on the anniversary of its capture. Jerome has drawn a vivid picture of the wretched crowds of Jews who in his day assembled at the wailing-place outside the west wall of the Temple court to bemoan the loss of their ancestral greatness. On the ninth of the month Ab might

SPECIAL STUDIES ABOUT THE JEWS

be seen the aged and decrepit of both sexes with tattered garments and dishevelled hair who met to weep over the downfall of Jerusalem, and purchased permission of the soldiery to prolong their lamentations. So completely were all traces of the ancient city obliterated that its very name was in process of time forgotten. It was not till after Constantine built the *Martyrion* on the site of the crucifixion that its ancient appellation was revived.

SECTION VI

SPECIAL STUDIES

- A. The SAMARITANS.
- B. JEWS OF THE DISPERSION
- C. The PROSELYTES
- D. JEWISH RELIGIOUS WRITINGS
- E. THE SYNAGOGUES.
- F. SECTS OF THE JEWS
 - 1. Origin and names of the Jewish sects
 - 2. The Pharisees
 - 3. The Sadducees
 - 4. The Essenes
 - 5. The Scribes
- G. The SANHEDRIN

WATCH FOR ANSWERS TO THESE QUESTIONS:

1. Were the Samaritans originally Jewish in origin, or did they come from other nations?
2. Did the Jews cooperate with Samaritans after the Babylonian captivity?
3. What man built a temple on Mt. Gerezim? Date?
4. Why did Jews who were travelling not pass through Samaria?

NEW TESTAMENT BACKGROUNDS

5. What section of the Bible was alone accepted by the Samaritans?
6. What was the attitude of the Jews toward Samaritans?
7. What is the modern city name *Nablus* derived from?
8. What are two ways in which the Samaritan Pentateuch differs from the Hebrew books of Moses?
9. What do we mean by the Jews of the *Dispersion*?
10. Where did the Jews of the Dispersion send money?
11. Were there few or many Jews in Asia Minor? Which apostle had much contact with Jews there?
12. What were the Jews who adopted Greek ideas and language called?
13. What city in Egypt had a large Jewish population?
14. What writings did the Jewish writers at Alexandria attempt to harmonize together?
15. What is the *allegorical* interpretation of scripture? Where was this first extensively practiced?
16. What city in north Africa had many Jewish inhabitants?
17. What Roman ruler first settled Jews into Rome?
18. What Roman emperor temporarily banished Jews from Rome?
19. How did the dispersion of the Jews relate to the preaching of the apostles (particularly Paul)?
20. What are proselytes?
21. How had many been made to be proselytes, other than by willing conversion?
22. What was a "proselyte of the gate"?
23. What were "proselytes of righteousness"?
24. Besides submitting to circumcision, what else were the proselytes of righteousness required to submit to?
25. What do we mean by the term *canon*?
26. When was the O.T. canon completed?
27. How many books did the Jews have in their canon (by their way of counting)?

SPECIAL STUDIES ABOUT THE JEWS

28. What were the names of the three divisions of the Hebrew canon?
29. What books do the Jews refer to as the "former prophets"?
30. When were the Jewish canonical books generally accepted as scripture?
31. Date of the council of Jamnia. What were some of its decisions?
32. When did Josephus say that the LAST of their scripture books had been written?
33. Did the Dead Sea colony at Qumran have any concept of the idea of canon? Were some books more sacred to them than others?
34. What is the name of the collection of books containing the TRADITIONS of the Jews?
35. What are the two parts of the Jewish Talmud? What is the relationship of these two parts to one another?
36. Besides the written law, what other law did the Pharisees believe that they possessed?
37. What does the word *Targum* refer to?
38. When did the Jewish Targums originate?
39. In what language are the Targums?
40. What name is given to the Greek Old Testament? What does this name mean?
41. Where was the Greek O.T. produced? Approximately when?
42. What is the name of the letter which (supposedly) tells of the production of the Greek O.T.?
43. Was the Septuagint version much used by the early Christian church?
44. Tell three differences between the Septuagint and the Hebrew Bible.
45. How many "books" constitute the Apocrypha?
46. What does the term *deutero-canonical* mean, and to what does it refer?

NEW TESTAMENT BACKGROUNDS

47. What is the primary meaning of *Apocrypha*?
48. During what centuries were the books of the Apocrypha produced?
49. What does the First book of Maccabees tell of?
50. What does the name *Pseudepigrapha* mean?
51. Why are certain books called *pseudepigrapha*? What other name is frequently used for these books?
52. What does the word *synagogue* mean?
53. When, apparently, did synagogues first appear?
54. State two influences that the synagogues had upon the Jews.
55. Synagogues were built in such a way that the worshippers faced toward what?
56. What was kept within the "ark" in each synagogue?
57. What officers in Christian churches were similar to those in the Jewish synagogues?
58. Give three particulars in which the synagogue ritual was followed in Christian churches.
59. During what period did the various sects of the Jews originate?
60. What were the principal sects of the Jews?
61. What is the root meaning of the name *Pharisee*?
62. What was the fundamental doctrine of the Pharisees?
63. Were the traditions of the Pharisees few or many, burdensome or easy to bear?
64. Why did Christ's eating with publicans and sinners so greatly shock the Pharisees?
65. Why would the Pharisees have been shocked by Christ's teaching that a man was not defiled by what he ate, but by bad thoughts alone?
66. Did the Pharisees believe in a future life?
67. Did the Pharisees attempt to make converts (proselytes)?
68. From what man's name (apparently) is the name *Saducee* derived?

SPECIAL STUDIES ABOUT THE JEWS

69. Were the Sadducees a lower-class or upper-class group?
70. What was the fundamental doctrine of the Sadducees?
71. Did the Sadducees believe in a resurrection of the dead?
72. Did the Sadducees believe in man's free will?
73. Did the Sadducees reject all scripture except the Pentateuch?
74. When did the sect of the Sadducees disappear?
75. What were the Essenes?
76. How many Essenes did Josephus say there were?
77. Where was one particular colony of Essenes?
78. Why did the Essenes generally withdraw from society?
79. When, possibly, did the Qumran colony originate?
80. When was the Qumran colony destroyed? By whom?
81. How many books did the Qumran Essenes have?
82. Give two arguments against the idea that Christian doctrines were derived from the Essene colony at Qumran.
83. What was the original ancient work of scribes?
84. What did the scribes become in the course of time?
85. Did the office of scribe develop into a good or evil system?
86. How authoritative did the traditions and decision of the scribes become?
87. Who were the founders of two "schools" within the order of the scribes?
88. Which of these two teachers was the more broad-minded and congenial?
89. Which of the two schools of the scribes was Gamaliel (Acts 5:34) connected with?
90. When did a boy start his training to become a scribe?
91. How honored and prominent were the scribes in the time of Christ?
92. What does the word *Sanhedrin* mean? To what group of Jews did the title refer in the time of Christ?
93. To what was the origin of the Sanhedrin traced?

94. When did the Sanhedrin probably originate?
95. What classes of men composed the Sanhedrin?
96. How many members did the Sanhedrin have?
97. What New Testament personages were brought to trial before the Sanhedrin?
98. What authority had been taken away from the Sanhedrin in the time of Christ?

A. THE SAMARITANS.

1. Their heathen origin.
2. Hostility of Samaritans to Jews.
3. Hostility of Jews to Samaritans.
4. History of the Samaritans.
5. The Samaritan Pentateuch.

Though jealously rejected by the Jews from the first moment of their return, the half-heathen Samaritans demand a place in Jewish history for their position in the very center of Palestine and from their own high claims of rivalry with the Jews.

1. *Their heathen origin.*

The strangers, whom we have seen placed in "the cities of Samaria" by Esarhaddon, were of course idolaters, and worshiped a strange medley of divinities. Each of the five nations, says Josephus, who is confirmed by the words of Scripture, had its own God. No place was found for the worship of Him who had once called the land His own and whose it was still. God's displeasure was kindled, and they were infested by beasts of prey which had probably increased to a great extent before their entrance upon the land. "The Lord sent lions among them, which slew some of them." On their explaining their miserable condition to the King of Assyria, he dispatched one of the captive priests to teach them "how they should fear the Lord." The priest came accordingly, and henceforth, in the language of the sacred historian, they "feared the Lord, and served their graven images, both their children and their

THE SAMARITANS

children's children: as did their fathers, so do they unto this day" (II K. 17:41). This statement exposes the pretensions of the Samaritans of Ezra's time to be pure worshipers of God—they were no more exclusively his servants than was the Roman Emperor, who desired to place a statue of Christ in the Pantheon, entitled to be called a Christian.

Such was the origin of the post-captivity or new Samaritans, men not of Jewish extraction, but from the further East.¹ Our Lord expressly terms them aliens (Luke 17:18). A gap occurs in their history until Judah has returned from captivity. They then desire to be allowed to participate in the rebuilding of the Temple at Jerusalem. It is curious, and perhaps indicative of the treacherous character of their designs, to find them even then called by anticipation, "the adversaries of Judah and Benjamin,"² a title which they afterward fully justified. But, so far as professions go, they are not enemies; they are most anxious to be friends. Their religion, they assert, is the same as that of the two tribes, therefore they have a right to share in that great religious undertaking. But they do not call it a *national* undertaking. They advance no pretensions to Jewish blood. They confess their Assyrian descent, and even put it forward ostentatiously, perhaps to enhance the merit of their partial conversion to God. That it was but partial they give no hint. It may have become purer already, but we have no information that it had. Be this, however, as it may, the Jews do not listen favorably to their overtures. Ezra, no doubt, from whose pen we have a record of the transaction, saw them through and through. On this the Samaritans throw off the mask, and become open enemies, frustrate the operations of the Jews through the reigns of two Persian kings, and are only effectually silenced in the reign of Darius Hystaspis, 519 B.C.

1. II K. 17:24. Josephus calls them Cutheans, from the interior of Persia and Media.

2. Ezra 4:1.

2. *Hostility of Samaritans to Jews.*

The feud, thus unhappily begun, grew year by year more inveterate. It is probable, too, that the more the Samaritans detached themselves from idols, and became devoted exclusively to a sort of worship of Jehovah, the more they resented the contempt with which the Jews treated their offers of fraternization. Matters at length came to a climax. About 409 B.C., a certain Manasseh, a man of priestly lineage, on being expelled from Jerusalem by Nehemiah for an unlawful marriage, obtained permission from the Persian king of his day, Darius Nothus, to build a temple on Mount Gerizim for the Samaritans, with whom he had found refuge. The only thing wanting to crystallize the opposition between the two races, viz., a rallying point for schismatical worship, being now obtained, their animosity became more intense than ever. The Samaritans are said to have done every thing in their power to annoy the Jews. They would refuse hospitality to pilgrims on their road to Jerusalem, as in our Lord's case (Luke 9:52-53). They would even waylay them in their journey;³ and many were compelled through fear to take the longer route by the east of Jordan. Certain Samaritans were said to have once penetrated into the Temple of Jerusalem and to have defiled it by scattering dead men's bones on the sacred pavement.⁴

Their own temple on Gerizim they considered to be much superior to that at Jerusalem. There they sacrificed a passover. Toward that mountain, even after the temple on it had fallen, wherever they were, they directed their worship. To their copy of the Law they arrogated an antiquity and authority greater than attached to any copy in the possession of the Jews. The Law (*i.e.*, the five books of Moses) was their sole code; for they rejected every other

3. Josephus, *Ant.* xx, 6, 1.

4. *Jos.*, *Ant.* xviii, 2, 2.

book in the Jewish canon. And they professed to observe it better than did the Jews themselves, employing the expression not unfrequently, "The Jews indeed do so and so; but we, observing the letter of the Law, do otherwise."

3. *Hostility of Jews to Samaritans.*

The Jews, on the other hand, were not more conciliatory in their treatment of the Samaritans. The copy of the Law possessed by that people they declared to be the legacy of an apostate (Manasseh), and cast grave suspicions upon its genuineness. Certain other Jewish renegades had from time to time taken refuge with the Samaritans. Hence, by degrees, the Samaritans claimed to partake of Jewish blood, especially if doings so happened to suit their interest.⁵ A remarkable instance of this is exhibited in a request which they made to Alexander the Great, about 332 B.C. They desired to be excused payment of tribute in the Sabbatical year on the plea that as true Israelites, descendants of Ephraim and Manasseh, sons of Joseph, they refrained from cultivating their land in that year. Alexander, on cross-questioning them, discovered the hollowness of their pretensions. They were greatly disconcerted at their failure and their dissatisfaction probably led to the conduct which induced Alexander to besiege and destroy the city of Samaria. Another instance of claim to Jewish descent appears in the words of the woman of Samaria to our Lord, "Art thou greater than *our father Jacob* which gave us this well?"⁶—a question which she puts without recollecting that she had just before strongly contrasted the Jews and the Samaritans. Very far were the Jews from admitting this claim to consanguinity on the part of these people. They were ever reminding them that they were after all mere Cuthæans, mere strangers from Assyria. They

5. *Ant.* xi. 8, 6; ix, 14, 3.

6. *John* 4:12.

accused them of worshiping the idol gods buried long ago under the oak of Shechem.⁷ They would have no dealings with them that they could possibly avoid. "Thou art a Samaritan and hast a devil," was the mode in which they expressed themselves when at a loss for a bitter reproach. Every thing that a Samaritan had touched was as swine's flesh to them. The Samaritan was publicly cursed in their synagogues—could not be adduced as a witness in the Jewish courts—could not be admitted to any sort of proselytism—and was thus, so far as the Jew could affect his position, excluded from hope of eternal life. The traditional hatred in which the Jew held him is expressed in Ecclus. 50:25, 26, "There be two manner of nations which my heart abhorreth, and the third is no nation: they that sit in the mountain of Samaria; and they that dwell among the Philistines; and that foolish people that dwell in Siche[m]." And so long was it before such a temper could be banished from the Jewish mind, that we find even the Apostles believing that an inhospitable slight shown by a Samaritan village to Christ would be not unduly avenged by calling down fire from heaven (Luke 9:54).

"Ye know not what spirit ye are of," said the large-hearted Son of Man, and we find him on no one occasion uttering any thing to the disparagement of the Samaritans. His words, however, and the records of his ministrations, confirm most thoroughly the views which has been taken above, that the Samaritans were not Jews. At the first sending forth of the Twelve, he charges them, "Go not into the way of Gentiles, and into any city of the Samaritans enter ye not, but go rather to the lost sheep of the house of Israel."⁸ So again, in his final address to them on Mount Olivet, "Ye shall be witnesses to me in Jerusalem and in all Judæa, and in Samaria, and unto the ut-

7. Gen. 35:4.

8. Matt. 10:5-6.

termost part of the earth." So the nine unthankful lepers, Jews, were contrasted by him with the tenth leper, the thankful *stranger*, who was a Samaritan. So, in his well-known parable, a merciful Samaritan is contrasted with the unmerciful priest and Levite. And the very worship of the two races is described by him as different in character. "Ye worship ye know not what," he said of the Samaritans: "We know what we worship, for salvation is of the Jews."⁹

Such were the Samaritans of our Lord's day: a people distinct from the Jews, though lying in the very midst of the Jews; a people preserving their identity, though seven centuries had rolled away since they had been brought from Assyria by Esarhaddon, and though they had abandoned their polytheism for a sort of ultra Mosaicism; a people, who still preserved nationality, still worshiped from Shechem and their other impoverished settlements toward their sacred hill; still retained their separation, and could not coalesce with the Jews.

4. *History of the Samaritans.*

The history of the Samaritans after their break from the Jews is not clearly known. In the light of the Samaritan papyri found in 1962 in the Jordan valley,¹⁰ it appears that the sequence of their kings was as follows:

- Sanballat I (ruling in 444 B.C. Neh. 2:10)
- Delaiah, son of Sanballat (c. 410 ff.)
- Sanballat II (c. 390 ff.)
- Hananiah, son of Sanballat II (ruling in 354)
- Sanballat III (c. 335 ff.)

Alexander the Great slaughtered many of the Samaritans. (See Section I of this book, under Alexander.) A Mace-

9. John 4:22.

10. *Biblical Archaeologist*, Dec. 1963, p. 120.

donian colony was formed at Samaria. The Samaritan's territory was gradually diminished. John Hyrcanus destroyed their temple on Mt. Gerezim in 109 B.C.

The Samaritans have continued to exist to this day. They have a tiny colony of about 400 in Nablus, which is a corruption of the name Neapolis, or "New Town," built by Vespasian a little west of the older town of Shechem, which was then ruined. They have a synagogue, and they observe the law and celebrate the Passover on a sacred spot on Mt. Gerezim with an exactness of minute ceremony which the Jews themselves have long since ceased to practice.

5. *The Samaritan Pentateuch.*

THE SAMARITAN PENTATEUCH is a Recension of the commonly received Hebrew Text of the Mosaic Law, in use with the Samaritans, and written in the ancient Hebrew, or so-called Samaritan character. It differs in several important points from the Hebrew text. Among these may be mentioned: 1. Emendations of passages and words of the Hebrew text which contain something objectionable in the eyes of the Samaritans, on account either of historical improbability or apparent want of dignity in the terms applied to the Creator. Thus in the Samaritan Pentateuch no one in the antediluvian times begets his first son after he has lived 150 years: but one hundred years are, where necessary, subtracted before, and added after, the birth of the first son. 2. Alterations made in favor or on behalf of Samaritan theology, hermeneutics, and domestic worship. Thus the word *Elohim*, four times constructed with the plural verb in the Hebrew Pentateuch is in the Samaritan Pent. joined to the singular verb (Gen. xx. 13, xxxi. 53, xxxv. 7; Ex. xxii. 9); and further, anthropomorph-

THE DISPERSION

isms as well as anthropopathisms¹¹ are carefully expunged—a practice very common in later times. The last and perhaps most momentous of all intentional alterations is the constant change of all the phrases, “God will choose a spot,” into “He has chosen,” viz., Gerizim, and the well-known substitution of Gerizim for Ebal in Deut. xxvii. 4. In Exodus as well as in Deuteronomy the Samaritan Pentateuch has immediately after the Ten Commandments, the following insertions from Deut. xxvii. 2-7 and xi. 30: “And it shall be on the day when ye shall pass over Jordan . . . ye shall set up these stones . . . on Mount *Gerizim* . . . and there shalt thou build an altar . . . ‘*That mountain*’ on the other side Jordan by the way where the sun goeth down . . . in the champaign over against Gilgal, beside the plains of Moreh, ‘*over against Shechem.*’ ”

The origin of the Samaritan Pentateuch has given rise to much controversy, into which we can not enter in this place. The two most usual opinions are: 1. That it came into the hands of the Samaritans as an inheritance from the ten tribes whom they succeeded. 2. That it was introduced by Manasseh, at the time of the foundation of the Samaritan Sanctuary on Mount Gerizim.

(For questions on the Samaritans, see numbers 1-8 on page 885-886.)

B. THE JEWS OF THE DISPERSION.

1. Origin and influence of the Dispersion.
2. Three divisions of the Dispersion.
3. Dispersed Jews in Asia Minor.
4. Dispersed Jews in Alexandria Egypt.
5. Dispersed Jews of north Africa.
6. Dispersed Jews at Rome.
7. Influence of the Jewish Dispersion upon Christianity.

11. Anthropomorphisms are references to God as if He had human form — arms, ears, eyes, etc. Anthropopathisms are references to God as if He had human feelings — repentance, sorrow, etc.

1. *Origin and influence of the Dispersion.*

THE JEWS OF THE DISPERSION, or simply THE DISPERSION, (Gr., *diaspora*) was the general title applied to those Jews who remained settled in foreign countries after the return from the Babylonian exile and during the period of the second Temple. The Dispersion as a distinct element influencing the entire character of the Jews dates from the Babylonian exile.

Apart from the inevitable influence which Jewish communities must have exercised on the nations among whom they were scattered, the difficulties which set aside the literal observance of the Mosaic ritual led to a wider view of the scope of the law, and a stronger sense of its spiritual significance. Outwardly and inwardly, by its effects both on the Gentiles and on the people of Israel, the Dispersion appears to have been the clearest providential preparation for the spread of Christianity.

But while the fact of a recognized Dispersion must have weakened the local and ceremonial influences which were essential to the first training of the people of God, the Dispersion was still bound together in itself and to its mother country by religious ties. The Temple was the acknowledged centre of Judaism, and the faithful Jew everywhere contributed the half-shekel toward its maintenance.¹ Treasuries were established to receive the payments of different districts, and the collected sums were forwarded to Jerusalem.

2. *Three divisions of the Dispersion.*

At the beginning of the Christian era the Dispersion was divided into three great sections, the *Babylonian*, the *Syrian*, the *Egyptian*. Precedence was yielded to the first. The jealousy which had originally existed between the

1. Matt. 17:24.

THE DISPERSION

poor who returned to Palestine and their wealthier countrymen at Babylon had passed away, and Gamaliel wrote "to the sons of the Dispersion in Babylonia, and to our brethren in Media . . . and to all the Dispersion of Israel." From Babylon the Jews spread throughout Persia, Media, and Parthia; but the settlements in China belong to a modern date. The few details of their history which have been preserved bear witness to their prosperity and influence. No schools of learning are noticed, but Hillel the Elder and Nahum the Mede are mentioned as coming from Babylon to Jerusalem.

3. *Dispersed Jews in Asia Minor.*

The Greek conquests in Asia extended the limits of the Dispersion. Seleucus Nicator transplanted large bodies of Jewish colonists from Babylonia to the capitals of his western provinces. His policy was followed by his successor Antiochus the Great; and the persecutions of Antiochus Epiphanes only served to push forward the Jewish emigration to the remoter districts of his empire. In Armenia the Jews arrived at the greatest dignities, and Nisibis, became a new centre of colonization. The Jews of Cappadocia² are casually mentioned in the Mishna; and a prince and princess of Adiabene adopted the Jewish faith only thirty years before the destruction of the Temple. Large settlements of Jews were established in Cyprus, in the islands of the Aegæan, and on the western coast of Asia Minor. Paul the apostle had many contacts with Jews in Asia Minor. The Romans confirmed to them the privileges which they had obtained from the Syrian kings; and though they were exposed to sudden outbursts of popular violence, the Jews of the Syrian provinces gradually formed a closer connection with their new homes, and together with the

2. I Peter 1:1.

Greek language adopted in many respects Greek ideas, and so became "*Hellenists*."

4. *Dispersed Jews at Alexandria Egypt.*

This Hellenizing tendency, however, found its most free development at *Alexandria*. According to Josephus, Alexander himself assigned to the Jews a place in his new city; "and they obtained," he adds, "equal privileges with the Macedonians"³ in consideration "of their services against the Egyptians."⁴ Ptolemy I. imitated the policy of Alexander, and after the capture of Jerusalem he removed a considerable number of its citizens to Alexandria. The numbers and importance of the Egyptian Jews were rapidly increased under the Ptolemies by fresh immigrations and untiring industry. Philo estimates them in his time at little less than 1,000,000; and adds, that two of the five districts of Alexandria were called "Jewish districts;" and that many Jews lived scattered in the remaining three. For some time the Jewish Church in Alexandria was in close dependence on that of Jerusalem. Both were subject to the civil power of the first Ptolemies, and both acknowledged the high-priest as their religious head. The persecution of Ptolemy IV. Philopator (217 B.C.) occasioned the first political separation between the two bodies. From that time the Jews of Palestine attached themselves to the fortunes of Syria; and the same policy which alienated the Palestinian party gave unity and decision to the Jews of Alexandria. The Septuagint translation, which strengthened the barrier of language between Palestine and Egypt, and the temple of Leontopolis (161 B.C.) which subjected the Egyptian Jews to the charge of schism, widened the breach which was thus opened. But the division, though marked, was not complete. At the beginning of the Christian era the Egyptian

3. *Contra Apion*, II, 4.

4. Josephus, *Wars*, II, 18, 7.

THE DISPERSION

Jews still paid the contributions to the temple-service. Jerusalem, though its name was fashioned to a Greek shape, was still the Holy City—the metropolis, not of a country, but of a people—and the Alexandrians had a synagogue there.⁵ The internal administration of the Alexandrine Church was independent of the Sanhedrin at Jerusalem; but respect survived submission.

Besides the political separation, the Alexandrine Jews developed a great separation in their ways of thinking from the Palestine Jews. At Alexandria Greek, Egyptian, pagan, and Jewish ideas co-existed in friendly union. The Jews became acquainted with pagan writings, and the Egyptian Jews necessarily imbibed the spirit which prevailed around them. Jewish writers began to try to harmonize the teachings of their law with Greek ideas. The allegoric exposition of the Pentateuch by Aristobulus, which is the earliest Greek fragment of Jewish writing that has been preserved (about 160 B.C.), contains large Orphic quotations which had been already moulded into a Jewish form, and the attempt thus made to connect the most ancient Hellenic traditions with the Law was often repeated afterward. This Aristobulus who gave currency to the Judæo-Orphic verses endeavored to show that the Pentateuch was the real source of Greek philosophy. Henceforth it was the chief object of Jewish speculation to trace out the subtle analogies which were supposed to exist between the writings of Moses and the teaching of the schools. The study of the Platonic philosophy at Alexandria gave a further impulse to this attempt. The belief in the existence of a spiritual meaning underlying the letter of Scripture was the great principle on which the Jewish investigations rested. The facts were supposed to be essentially symbolic: the language the veil (or sometimes the mask) which partly disguised from common sight the truths which it enwrapped. This was the

5. Acts 6:9.

origin of what is called the *allegorical* interpretation of the scriptures.

5. *Dispersed Jews of north Africa.*

The Jewish settlements established at Alexandria by Alexander and Ptolemy I. became the source of the *African Dispersion*, which spread over the north coast of Africa, and perhaps inland to Abyssinia. At Cyrene (Acts 11:20) and Berenice (Tripoli) the Jewish inhabitants formed a considerable portion of the population. The African Dispersion, like all other Jews, preserved their veneration for the "Holy City," and recognized the universal claims of the Temple by the annual tribute. But the distinction in language led to wider differences, which were averted in Babylon by the currency of an Aramaic dialect. The Scriptures were no longer read on the Sabbath. Still the national spirit of the African Jews was not destroyed. After the destruction of the Temple, the Zealots found a reception in Cyrene, and toward the close of the reign of Trajan, A.D. 115, the Jewish population in Africa rose with terrible ferocity. The insurrection was put down by a war of extermination, and the remnant who escaped established themselves on the opposite coast of Europe, as the beginning of a new Dispersion.

6. *Dispersed Jews at Rome.*

The Jewish settlements in *Rome* were consequent upon the occupation of Jerusalem by Pompey, 63 B.C. The captives and emigrants whom he brought with him were located in the trans-Tiberine quarter, and by degrees rose in station and importance. They were favored by Augustus and Tiberius after the fall of Sejanus; and a Jewish school was founded at Rome. In the reign of Claudius, the Jews became objects of suspicion from their immense

THE DISPERSION

numbers; and the internal disputes, consequent perhaps upon the preaching of Christianity, led to their banishment from the city.⁶ This expulsion, if general, can only have been temporary, for in a few years the Jews at Rome were numerous,⁷ and continued to be sufficiently conspicuous to attract the attention of the satirists.

7. Influence of the Jewish Dispersion upon Christianity.

The influence of the Dispersion on the rapid promulgation of Christianity can scarcely be overrated. The course of the apostolic preaching followed in a regular progress the line of the Jewish settlements. The mixed assembly from which the first converts were gathered on the day of Pentecost represented each division of the Dispersion;⁸ (1) Parthians . . . Mesopotamia; (2) Judæa (i.e. Syria) . . . Pamphylia; (3) Egypt . . . Greece; (4) Romans . . . ; and these converts naturally prepared the way for the apostles in the interval which preceded the beginning of the separate apostolic missions. The names of the seven deacons are all Greek, and one is specially described as a proselyte.⁹ The church at Antioch, by which St. Paul was entrusted with his great work among the heathen,¹⁰ included Barnabas of Cyprus, Lucius of Cyrene, and Simon surnamed Niger; and among his "fellow-laborers" at a later time are found Aquila of Pontus,¹¹ Apollos of Alexandria, and Urbanus, and Clement, whose names, at least, are Roman. Antioch itself became a centre of the Christian Church, as it had been of the Jewish Dispersion; and throughout the apostolic journeys the Jews were the class

6. Acts 18:2.

7. Acts 28:17 ff.

8. Acts 2:9-11.

9. Acts 6:5.

10. Acts 13:1.

11. Acts 18:2.

NEW TESTAMENT BACKGROUNDS

to whom "it was necessary that the Word of God should be first spoken,"¹² and they in turn were united with the mass of the population by the intermediate body of "the devout," which had recognized in various degrees "the faith of the God of Israel."

(For questions about the Dispersion of the Jews, see numbers 9-19, page 886.)

C. THE PROSELYTES.

1. Willing converts to the Jewish faith.
2. Dark side of proselytism.
3. Proselytes of the gate.
4. Proselytes of Righteousness; their baptism.

1. *Willing converts to the Jewish faith.*

The *proselytes* were people of various nationalities who became converts to the Jewish faith, willingly, for the most part. With the conquests of Alexander, the wars between Egypt and Syria, the struggle under the Maccabees, the expansion of the Roman empire, the Jews became more widely known, and their power to proselytize increased. The influence was sometimes obtained well, and exercised for good. In most of the great cities of the empire there were men who had been rescued from idolatry and its attendant debasements, and brought under the power of a higher moral law. The converts who were thus attracted joined, with varying strictness, in the worship of the Jews. They were present in their synagogues;¹ they came up as pilgrims to the great feasts at Jerusalem.² In Palestine itself the influence was often stronger and better. Even Roman centurions learned to love the conquered nation, built synagogues for them,³ fasted and prayed, and gave alms, after the pattern of the strictest Jews,⁴ and became preachers of

12. Acts 13:46.

1. Acts 13:42-43, 50; 17:4; 18:7.

2. Acts 2:10.

3. Luke 7:5.

4. Acts 10:2, 30.

THE JEWS AND PROSELYTES

the new faith to the soldiers under them.⁵ Such men, drawn by what was best in Judaism, were naturally among the readiest receivers of the new truth which rose out of it, and became, in many cases, the nucleus of a Gentile church.

2. *Dark side of proselytism.*

Proselytism had, however, its darker side. The Jews of Palestine were eager to spread their faith by the same weapons as those with which they had defended it. Had not the power of the Empire stood in the way, the religion of Moses, stripped of its higher elements, might have been propagated far and wide by force, as was afterward the religion of Mahomet. As it was, the Idumæans had the alternative offered by John Hyrcanus of death, exile, or circumcision⁶ The Ituræans were converted in the same way by Aristobulus.⁷ Where force was not in their power, they obtained their ends by the most unscrupulous fraud. They appeared as soothsayers, diviners, exorcists; and addressed themselves especially to the fears and superstitions of women. Their influence over these became the subject of indignant satire.⁸ Those who were most active in proselytizing were precisely those from whose teaching all that was most true and living had departed. The vices of the Jew were engrafted on the vices of the heathen. A repulsive casuistry released the convert from obligations which he had before recognized,⁹ while in other things he was bound, hand and foot, to an unhealthy superstition. It was no wonder that he became "twofold more the child of hell"¹⁰ than the Pharisees themselves.

5. Acts 10:7.

6. Josephus, *Ant.*, xiii, 9, 8.

7. *Ant.* xiii, 11, 8.

8. Juvenal, *Satire*, vi, 543-547.

9. See law of Corban, Matt. 15:4-6.

10. Matt. 23:15.

The position of such proselytes was indeed every way pitiable. At Rome, and in other large cities, they became the butts of popular scurrility. Among the Jews themselves their case was not much better. For the most part the convert gained but little honor, even from those who gloried in having brought him over to their sect and party. (Comp. Gal. 4:17.)

3. *Proselytes of the Gate.*

We find in the Talmud a distinction between Proselytes of the Gate and Proselytes of Righteousness.

The term *Proselytes of the Gate* was derived from the frequently occurring description in the Law, "the stranger that is within thy gates."¹¹ Converts of this class were not bound by circumcision and the other special laws of the Mosaic code. It was enough for them to observe the seven precepts of Noah—*i.e.*, the six supposed to have been given to Adam, (1) against idolatry, (2) against blaspheming, (3) against bloodshed, (4) against uncleanness, (5) against theft, (6) of obedience, with (7) the prohibition of "with the blood thereof" given to Noah. The proselyte was not to claim the privileges of an Israelite, might not redeem his first-born, or pay the half-shekel. He was forbidden to study the Law under pain of death. The later Rabbis insisted that the profession of his faith should be made solemnly in the presence of three witnesses. The Jubilee was the proper season for his admission. All this seems so full and precise that it has led many writers to look on it as representing a reality; and most commentators accordingly have seen these Proselytes of the Gate in the "Religious proselytes," "the devout persons," "devout men," of the Acts.¹² It remains doubtful, however, whether it was ever more than a paper scheme of what ought to be,

11. Ex. 20:10; etc.

12. Acts 13:43; 17:4, 17; 2:5.

disguising itself as having actually been. All that can be said is, that in the time of the N. T. we have some evidence of the existence of converts of two degrees, and that the Talmudic division is the formal systematizing of an earlier fact.

4. *Proselytes of Righteousness; their baptism.*

The *Proselytes of Righteousness*, known also as *Proselytes of the Covenant*, were perfect Israelites. We learn from the Talmud that, in addition to circumcision, baptism was also required to complete their admission to the faith. The proselyte was placed in a tank or pool, up to his neck in water. His teachers, who now acted as his sponsors, repeated the great commandments of the Law. These he promised and vowed to keep, and then, with an accompanying benediction, he plunged under the water. To leave one hand-breadth of his body unsubmerged would have vitiated the whole rite. The Rabbis carried back the origin of the baptism to a remote antiquity, finding it in the command of Jacob¹³ and of Moses.¹⁴ The Targum of the Pseudo-Jonathan inserts the word "Thou shalt circumcise and baptize" in Ex. xii 44. Even in the Ethiopic version of Matt. xxiii. 15, we find "compass sea and land to baptize one proselyte." The baptism was followed, as long as the Temple stood, by the offering or Corban.

It is obvious that this account suggests many questions of grave interest. Was this ritual observed as early as the commencement of the first century? If so, was the baptism of John, or that of the Christian Church, in any way derived from, or connected with, the baptism of proselytes? If not, was the latter in any way borrowed from the former?

13. Gen. 35:2.

14. Ex. 19:10.

The Dead Sea colony at Qumran (where the Dead Sea Scrolls were written) practiced a type of baptism. Their washing was not an initiatory rite (like Christian baptism), but was rather reserved for those already in their community.¹⁵ Their practice was an immersion of the entire person.

The N. T. teaching on baptism did not, therefore, deal with a subject unfamiliar to the Jews. It was already a meaningful act in their religion. The question of the priests and Levites to John the baptizer, "Why baptizest thou then?" (John 1:25) implies that they wondered, not at the act itself, but that it was done by one who disclaimed any authority, or any title such as Messiah or "Elijah," which might have justified his introduction of a new dispensation.

(For questions on the Proselytes, see numbers 20-24, page 886.)

D. JEWISH RELIGIOUS WRITINGS.

1. The Hebrew Canon.
 - a. Number of books.
 - b. Books in the Hebrew canon.
 - c. Acceptance of the books as canon.
 - d. Evidence of the close of the canon.
 - e. Critical ideas about the canon.
2. The Talmud: Mishna and Gemara.
3. The Targums.
4. The Greek Old Testament, the Septuagint.
5. The Apocrypha (or Deuterocanonical books); Brief accounts of the various books of the Apocrypha.
6. The Pseudepigrapha.

15. Wm. S. LaSor, *Dead Sea Scrolls and the Christian Faith* (Chicago: Moody, 1969), p. 79.

THE JEWISH SACRED BOOKS

1. *The Hebrew Canon*'.

The study of the O.T. canon rightly belongs to O.T. History, before 420 B.C., rather than to the period after the end of O.T. history. The reason for this is that the last O.T. books, Malachi and Chronicles, seem to have been completed very shortly after the last events of O.T. history were completed.

a. *Number of books.*

The Jews had many religious books, but only 22 of these were regarded as "defiling the hands," that is, they were so sacred that the hands of those who handled them became too holy to permit of handling lesser books at the same time. The N.T. speaks of such books as "inspired of God," that is, "breathed of God" (II Tim. 3:16). They are the collection which Jesus referred to as "the scriptures" (Matt. 22:29).

b. *Books of the Hebrew canon.*

The Hebrew arrangement and groupings of their sacred books differ somewhat from the English O.T., although the Hebrew authorities differ among themselves sufficiently about this to indicate that the arrangement of the books is not a matter of particular significance or divine revelation. Generally, but not always, the Hebrew scriptures are arranged in this order:

(1) The Torah, or law: 5 books, Gen. through Deut.

1. The word *canon* comes from the Hebrew *kaneh*, modified into Greek as *kanon*, and originally meant a measuring stick or measuring reed. (See Ezekiel 40:3). From this meaning its applications were extended to mean any type of law or principle which was a standard to be measured up to, in science, morals, etc. Then its meaning was further extended to become the title of the books or writings which thus functioned as the standard for measurement. In its present use the word *canon* simply means "those books regarded as divinely revealed scripture."

NEW TESTAMENT BACKGROUNDS

- (2) The Prophets, or *Nevi'im*
 - (a) The Former Prophets: Joshua, Judges, I & II Samuel; I & II Kings
 - (b) The Latter Prophets: Isaiah, Jeremiah, Ezekiel, The Twelve (Hosea through Malachi, counted as one scroll)
- (3) The Writings, or *Kethubim* (called in Greek *Hagiographa*, or Holy Writings)
 - (a) Psalms, Proverbs, Job
 - (b) The Five Megilloth, or rolls: Song, Ruth, Lamentations, Ecclesiastes, Esther (all in one scroll)
 - (c) Daniel
 - (d) Ezra-Nehemiah (regarded as one scroll)
 - (e) Chronicles (both in one scroll)

The arrangement and groupings of the O.T. books in our English Bibles differs from the Hebrew arrangement, in that it follows the order as given in the Greek Septuagint O.T., as altered slightly through the Latin Vulgate. As stated above, the order of the books does not appear to be a matter of divine revelation.

c. Acceptance of the books as canon.

It appears that these writings were generally accepted by the God-fearing people as soon as they were produced, as the authoritative utterances of divinely qualified prophets. The disobedient people neither accepted them at the time of their production, nor have they at any time since. Note that Moses' writings were at once accepted (Ex. 24:7). Also note that the God-fearing people at once accepted Jeremiah's writings, while the ungodly rejected them (Jer. 36:15-16, 23-24). There was no necessity for a long period for canonization to transpire; nor did any decision by any council or group either make a book to be "inspired"

THE JEWISH SACRED BOOKS

or prevent its being so accepted. Canonization was therefore for all practical purposes simultaneous with production. Books written by verified prophets were received upon the authority of their authors.

The final formal acceptance of the O.T. canon was not actually done until the Council at Jamnia in A.D. 90, when the Jewish Rabbis met together to give official endorsement and enforcement to the books in their canon. This council rejected the Septuagint version, the Apocrypha, and all Christian writings. It authorized production of a new Greek Bible (Aquila's version). This council was convened to combat the growing influence of Christian teaching among the Jews. The Christians had generally been using the Jews' own Septuagint Bible to prove Christian teachings. This led the Jews to condemn their own Greek Bible.

In giving legal endorsement to the books of the Hebrew canon, the rabbis at the Council of Jamnia did not cause the books to become canon; they only gave legal force to the recognition of the books that had already for centuries been accepted as the word of the Lord by multitudes of believing Israelites.

d. Evidence of the close of the canon

In spite of modern critical opinions to the contrary (see below), all the real evidence we have indicates that the books we call the O.T. canon were all completed and accepted by the time of Ezra, about 420 B.C.

Josephus, the Jewish historian of about A.D. 80 writes:

We have not an innumerable multitude of books among us, disagreeing and contradicting one another (as the Greeks have,) but only twenty-two books. . . . It is true, our history hath been written since Artaxerxes [I, king of Persia, 465-

424 B.C.], but hath not been esteemed of the like authority with the former by our forefathers, because there hath not been an exact succession of prophets since that time; and how firmly we have given credit to these books of our own nation is evident by what we do; for during so many ages as we have already passed, no one has been so bold as either to add anything to them, to take anything from them, or to make any change in them. (*Against Apion*, I, 8)

The Jewish Talmud (*Baba Bathra* 14b-15a) declares that Moses wrote his own book and the portion of Balaam and Job. Joshua wrote the book which bears his name and the (the last) eight verses of the Pentateuch. Samuel wrote the book which bears his name and the Book of Judges and Ruth . . . The men of the Great Synagogue wrote Ezekiel, the Twelve Minor Prophets, Daniel, and the Scroll of Esther. Ezra wrote the book that bears his name, and the genealogies of the Book of Chronicles up to his own time.

The Jewish Apocryphal book *Ecclesiasticus* (written about 180 B.C. and translated into Greek about 130 B.C.) refers in its prologue to the "law, and the prophets, and the other books of our fathers." This seems to refer to the three-part division of the Hebrew scriptures (Torah, Nevi'im, Kethubim) that modern Hebrew Bibles follow. Although 130 B.C. is not as far back as the time of Ezra, it is still much earlier than many modern critical authors are willing to date the completion of the Hebrew canon.

e. *Critical ideas about the canon*

The prevailing-modern critical view is that the five books of Moses were first partly written down about 1000 B.C., and then not fully completed and canonized till after

THE JEWISH SACRED BOOKS

the Babylonian captivity, about 450 B.C., nearly 1000 years after Moses! The "prophets" were supposedly not completed nor accepted as canon until about 250 B.C., and the "writings" were not made canon until about 90 A.D.! Jonah is dated anywhere from 400 to 250 B.C. Ecclesiastes and Daniel are dated about 165 B.C. Esther is dated about 125 B.C. These opinions are without any substantial evidence for them, and were formulated as a result of an evolutionary concept of the development of religion, and a skeptical attitude toward the existence of all predictive prophecy. Since the O.T. contains many clear predictions of such events as the conquest of Alexander and the persecutions of Antiochus Epiphanes (168 B.C.), and since critics doubt the existence of predictive prophecy, they naturally have attempted to date books containing such prophecies after the events they tell of. We prefer to believe the testimony of the Lord Jesus, who accepted the reality of prophetic predictive scripture on many occasions (for example see Luke 24:27).

It has been alleged that the Dead Sea colony at Qumran was not acquainted with any concept of "canon" in their time (150 B.C.-A.D. 68), because they had in their libraries MANY other books besides those of our commonly accepted canon. This does not prove that they had no idea of canon, any more than the fact that in Christian libraries there are many books besides the basic Bible books proves that they have no idea of canon. Actually the Qumran people did show a special reverence for the law and the prophets far beyond that paid to other books. The fact that at least five scrolls or parts of scrolls of Isaiah were found at Qumran shows the stress given to this prophet.

The opening statement in their *Manual of Discipline* states that everyone who wishes to join the community must pledge . . . to do what is good and upright in His

sight, in accordance with what He has commanded through Moses, and through His servants the prophets (i. 1-2). This sounds as though Moses and the prophets (comp. Luke 16:29) were canon at Qumran, rather than their multitudinous other books. Admittedly the issue of canon was not as live an issue among the Qumran covenanters as it became among the Jews a century later; but they nonetheless seem to have had about the same views of scripture canon as other Jews.

2. *The Talmud: Mishna and Gemara.*

The *Talmud* is one of the two important branches of Jewish literature (the other being the *Targums*) which began to develop after the return from Babylonian captivity.

The *Mishna*, or the "second law," which forms the first portion of the Talmud, is a digest of the Jewish traditions, and a compendium of the whole ritual law, and represents the traditions which were current among the Jews at the time of Christ. The Talmud seems to have been put into final written form in the second through fifth centuries after Christ.

The Mishna was very concisely written, and requires notes. This circumstance led to the Commentaries called *Gemara*¹ (i.e., Supplement, Completion), which form the second part of the Talmud, and which are very commonly meant when the word "Talmud" is used by itself. The language of the Mishna is that of the later Hebrew, purely written on the whole, though with a few grammatical Aramaisms, and interspersed with Greek, Latin and Aramaic words which had become naturalized. The Mishna contains the *oral tradition*, which at length came to be esteemed far above the sacred text. It was the fundamental prin-

1. There are two gemaras; one of Jerusalem, in which there is said to be no passage which can be proved to be later than the first half of the 4th century; and the other of Babylon, completed about 500 A.D. The latter is the most important, and by far the longest.

ciple of the Pharisees that by the side of the written law there was an oral law to complete and to explain the written law. It was an article of faith that in the Pentateuch there was no precept, and no regulation, ceremonial, doctrinal, or legal, of which God had not given to Moses all explanations necessary for their application, with the order to transmit by word of mouth. The classical passage in the Mishna on this subject is the following:—"Moses received the (oral) law from Sinai, and delivered to it Joshua, and Joshua to the elders, and the elders to the prophets, and the prophets to the men of the Great Synagogue."

3. *The Targums.*

The Jews, on the return from captivity, no longer spoke the Hebrew language; and as the common people had lost all knowledge of the tongue in which the sacred books were written, it naturally followed that recourse must be had to a translation into the idiom with which they were familiar—Aramaic, formerly miscalled Chaldee. Moreover, since a bare translation could not in all cases suffice, it was necessary to add to the translation an explanation, or paraphrase, particularly of the more difficult and obscure passages. Both translation and paraphrase were designated by the term *Targum* which means "interpretation." The Targums were originally oral, and the earliest Targum, which is that of Onkelos (or Aquila) on the Pentateuch, began to be committed to memory about the 2d century of the Christian era; though it did not assume its present shape till the end of the 3d, or the beginning of the 4th century. It is written in the Aramaic dialect, closely approaching in purity of idiom to that of Ezra and Daniel. It follows a sober and clear, though not a slavish exegesis, and keeps as closely and minutely to the text as is at all consistent with its purpose, viz., to be chiefly, and above all, a *version for the people*. Its ex-

planations of difficult and obscure passages bear ample witness to the competence of those who gave it its final shape. It avoids the legendary character with which all the later Targums entwine the Biblical word, as far as ever circumstance would allow.

A Targum on the prophets (Joshua to Kings, Isaiah to Malachi) was produced in Babylon in the fourth century A.D., and is called the Targum of Jonathan ben Uzziel. It is not as reliable as is the Targum of Onkelos.

4. *The Greek Old Testament, the Septuagint.*

THE SEPTUAGINT or Greek version of the Old Testament owed its origin to the same cause as the Targums. The Jews of Alexandria had probably still less knowledge of Hebrew than their brethren in Palestine; their familiar language was Alexandrian Greek. They had settled in Alexandria in large numbers soon after the time of Alexander, and under the early Ptolemies. They would naturally follow the same practice as the Jews in Palestine; and hence would arise in time an entire Greek version. But the numbers and names of the translators and the times at which different portions were translated are all uncertain. The common received story respecting its origin is contained in an extant letter ascribed to Aristeas who was an officer at the court of Ptolemy Philadelphus. This letter, which is addressed by Aristeas to his brother, Philocrates, gives a splendid account of the origin of the Septuagint; of the embassy and presents sent by King Ptolemy to the high-priest at Jerusalem, by the advice of Demetrius Phalereus, his librarian, 50 talents of gold and 70 talents of silver, etc.; the Jewish slaves whom he set free, paying their ransom himself; the letter of the king; the answer of the high-priest; the choosing of six interpreters from each of the twelve tribes, and their names; the copy of the Law, in letters of gold; the feast prepared for the seventy-two, which continued

THE JEWISH SACRED BOOKS

for seven days; the questions proposed to each of the interpreters in turn, with the answers of each; their lodging by the sea-shore; and the accomplishment of their work in seventy-two days by conference and comparison. This is the story which probably gave to the Version the title of the Septuagint and which has been repeated in various forms by the Christian writers. But it is now generally admitted that the letter is spurious, and is probably the fabrication of an Alexandrian Jew shortly before the Christian era. Still there can be no doubt that there was a basis of fact for the fiction: on three points of the story there is no material difference of opinion, and they are confirmed by the study of the Version itself:—1. The Version was made at Alexandria. 2. It was begun in the time of the earlier Ptolemies, about 280 B.C. 3. The Law (*i.e.*, the Pentateuch) alone was translated at first.

The name *Septuagint* means "The Seventy," referring to the 70 supposed translators. It is commonly abbreviated as LXX.

The Septuagint version was highly esteemed by the Hellenistic Jews before the coming of Christ. The manner in which it is quoted by the writers of the New Testament proves that it had been long in general use. Wherever, by the conquests of Alexander, or by colonization, the Greek language prevailed; wherever Jews were settled, and the attention of the neighboring Gentiles was drawn to their wondrous history and law, there was found the Septuagint, which thus became, by Divine Providence, the means of spreading widely the knowledge of the One True God, and his promises of a Saviour to come, throughout the nations. To the wide dispersion of this version we may ascribe in great measure that general persuasion of the near approach of the Redeemer which prevailed over the whole East, and led the Magi to recognize the star which proclaimed the birth of the King of the Jews.

Not less wide was the influence of the Septuagint in the spread of the Gospel. Many of those Jews who were assembled at Jerusalem on the day of Pentecost, from Asia Minor, from Africa, from Crete and Rome, used the Greek language; the testimonies to Christ from the Law and the Prophets came to them in the words of the Septuagint; St. Stephen probably quoted from it in his address to the Jews; the Ethiopian eunuch was reading the Septuagint version of Isaiah in his chariot; they who were scattered abroad went forth into many lands, speaking of Christ in Greek, and pointing to the things written of him in the Greek version of Moses and the Prophets; from Antioch and Alexandria in the East, to Rome and Massilia in the West, the voice of the Gospel sounded forth in Greek; Clement of Rome, Ignatius at Antioch, Justin Martyr in Palestine, Irenæus at Lyons, and many more, taught and wrote in the words of the Greek Scriptures; and a still wider range was given to them by the Latin version (or versions) made from the LXX for the use of the Latin Churches in Italy and Africa; and in later times by the numerous other versions into the tongues of Egypt, Ethiopia, Armenia, Arabia, and Georgia. For a long period the Septuagint was the Old Testament of the far larger part of the Christian Church.

The LXX differs in the order of the books from the Hebrew Bible. (Its order is similar to that of our English Bible, which was derived from the LXX through the Latin Vulgate Bible, which is a translation of the LXX.) The LXX includes several of the apocryphal books. Throughout it has numerous small variant textual readings from the Hebrew Bible. In a few books (e.g., Exodus, Jeremiah, Samuel) the LXX has many chapters that differ greatly from the Hebrew.

Numerous manuscripts from the Dead Sea scrolls have shown that some of the textual variants of the LXX also

existed in some Hebrew manuscripts. This has caused a greater respect for the LXX, and some minor corrections of the O.T. text may be made in the light of these discoveries. However, these variations are not sufficient to make our standard Hebrew Bibles untrustworthy. In the vast majority of verses the readings of the Greek and Hebrew Bibles are practically identical, and in some places the LXX itself is obviously in error.

5. *The Apocrypha (or Deutero-canonical books)*

a. THE APOCRYPHA. The collection of Books to which this term is popularly applied includes the following. The order given is that in which they stand in the English version. I. 1 Esdras. II. 2 Esdras. III. Tobit. IV. Judith. V. The rest of the chapters of the Book of Esther, which are found neither in the Hebrew nor in the Aramaic. VI. The Wisdom of Solomon. VII. The Wisdom of Jesus the Son of Sirach, or Ecclesiasticus. VIII. Baruch. IX. The Song of the Three Holy Children. X. The History of Susanna. XI. The History of the destruction of Bel and the Dragon. XII. The Prayer of Manasseh, king of Judah. XIII. 1 Maccabees. XIV. 2 Maccabees.

The primary meaning of *Apocrypha*, "hidden, secret," seems, toward the close of the 2d century, to have been associated with the signification "spurious," and ultimately to have settled down into the latter. The conjectural explanation given in the translation of the English Bible, "because they were wont to be read not openly and in common, but as it were in secret and apart," is, as regards some of the books now bearing the name, at variance with fact. The term *Deutero-canonical* is often applied to these books. This term means "belonging to the second (and presumably inferior) canon."

It was almost a matter of course that these secret books should be pseudonymous, ascribed to the great names in

Jewish or heathen history that had become associated with the reputation of a mysterious wisdom. So books in the existing Apocrypha bear the names of Solomon, Daniel, Jeremiah, Ezra. These books represent the period of transition and decay which followed on the return from Babylon when the prophets who were then the teachers of the people had passed away and the age of scribes succeeded. Uncertain as may be the dates of individual books, few, if any, can be thrown further back than the commencement of the 3d century B.C. The latest, the 2d Book of Esdras, is probably not later than 30 B.C., 2 Esdr. vii. 28 being a subsequent interpolation. The alterations of the Jewish character, the different phases which Judaism presented in Palestine and Alexandria, the good and the evil which were called forth by contact with idolatry in Egypt, and by the struggle against it in Syria, all these present themselves to the reader of the Apocrypha with greater or less distinctness.

The following is a brief account of the separate books:

(1) *The First and Second Books of Esdras* are called in the Vulgate, and in all the earlier editions of the English Bible, the *third* and *fourth* books. In the Vulgate 1st Esdras means the canonical book of Ezra, and 2d Esdras means Nehemiah. (*Esdras* is a Greek form of Ezra.)

(a) *First Book of Esdras*.—The first chapter is a transcript of the two last chapters of 2 Chr., for the most part *verbatim*. Chapters iii., iv., and v., to the end of v. 6, are the *original* portions of the book, and the rest is a transcript more or less exact of the book of Ezra, with the chapters transposed and quite otherwise arranged, and a portion of Nehemiah. Hence a twofold design in the compiler is discernible: one to introduce and give Scriptural sanction to the legend about Zerubbabel; the other to explain the obscurities of the book of Ezra, in which however he has signally failed. The *original* portion of the book seems to

indicate that the writer was thoroughly conversant with Hebrew even if he did not write the book in the language.

(b) *The Second Book of Esdras* was originally called "the Apocalypse of Ezra," which is a far more appropriate title. The Greek text in which it was originally written is lost. The common Latin text, which is followed in the English version, contains two important interpolations (Ch. i. ii.; xv. xvi.) which are not found in the Arabic and Aethiopic versions, and are separated from the genuine Apocalypse in the best Latin MSS. Both of these passages are evidently of Christian origin. The original Apocalypse (iii.-xiv.) consists of a series of angelic revelations and visions, in which Ezra is instructed in some of the great mysteries of the moral world, and assured of the final triumph of the righteous.

(2) *Tobit*.—The scene of this book is placed in Assyria, whither Tobit, a Jew, had been carried as a captive by Shalmaneser. But it must have been written considerably later than the Babylonian captivity, and can not be regarded as a true history. It is a didactic narrative; and its point lies in the moral lessons which it conveys, and not in the narrative. In modern times the moral excellence of the book has been rated highly, except in the heat of controversy. Luther pronounced it, if only a fiction, yet "a truly beautiful, wholesome, and profitable fiction, the work of a gifted poet. . . . A book useful for Christian reading." Nowhere else is there preserved so complete and beautiful a picture of the domestic life of the Jews after the Return.

(3) *Judith*.—This book, like that of Tobit, belongs to the earliest specimens of historical fiction. The narrative of the reign of "Nebuchadnezzar king of Nineveh" (i.1), of the campaign of Holofernes, and the deliverance of Bethulia, through the stratagem and courage of the Jewish heroine, contains too many and too serious difficulties, both historical and geographical, to allow of the

supposition that it is either literally true, or even carefully moulded on truth. But the value of the book is not lessened by its fictitious character. On the contrary it becomes even more valuable as exhibiting an ideal type of heroism, which was outwardly embodied in the wars of independence. The self-sacrificing faith and unscrupulous bravery of Judith were the qualities by which the champions of Jewish freedom were then enabled to overcome the power of Syria, which seemed at the time scarcely less formidable than the imaginary hosts of Holofernes. The peculiar character of the book, which is exhibited in these traits, affords the best indication of its date; for it can not be wrong to refer its origin to the Maccabæan period, which it reflects not only in its general spirit but even in smaller traits.

(4) *The Rest of Esther*—

These six "Additions," totalling 107 verses, consist of passages which were inserted throughout and after the canonical book of Esther in the LXX. They consist of visions, letters, prayers, etc. designed to show the hand of God in the narrative. While the book itself never mentions God's name, the "Additions" mention God many times. Bruce Metzger thinks that these additions were first inserted into Esther about 114 B.C.

(5) *The Wisdom of Solomon*.—This book may be divided into two parts, the first (ch. i.-ix.) containing the doctrine of Wisdom in its moral and intellectual aspects; the second, the doctrine of Wisdom as shown in history (ch. x.-xix.). The first part contains the praise of Wisdom as the source of immortality, in contrast with the teaching of sensualists; and next the praise of Wisdom as the guide of practical and intellectual life, the stay of princes, and the interpreter of the universe. The second part, again, follows the action of Wisdom summarily, as preserving God's servants, from Adam to Moses, and more

particularly in the punishment of the Egyptians and Canaanites (xi. 5-16; xi. 17-xii.). From internal evidence it seems most reasonable to believe that the book was composed at Alexandria some time before the time of Philo (about 120-80 B.C.).

(6) *The Wisdom of Jesus the son of Sirach*, or *Ecclesiasticus*.—The former is the title of this book in the Septuagint, the latter in the Vulgate, the name "Ecclesiasticus" indicating that the book was publicly used in the service of the Church. Of its author, Jesus (*i.e.*, Jeshua or Joshua), the son of Sirach, "of Jerusalem," we know absolutely nothing; but his Palestinian origin is substantiated by internal evidence. The language in which the book was originally composed was Hebrew, that is, probably, the vernacular Aramæan dialect. It was translated into Greek by the grandson of the author, in Egypt "in the reign of Euergetes," for the instruction of those "in a strange country who were previously prepared to live after the law." It is an important monument of the religious state of the Jews at the period of its composition. As an expression of Palestinian theology it stands alone; for there is no sufficient reason for assuming Alexandrine interpolations or direct Alexandrine influence. The conception of God as Creator, Preserver, and Governor, is strictly conformable to the old Mosaic type; but at the same time his mercy is extended to all mankind. Little stress is laid upon the spirit-world, either good or evil; and the doctrine of a resurrection fades away. In addition to the general hope of restoration, one trait only of a Messianic faith is preserved, in which the writer contemplates the future work of Elias. The ethical precepts are addressed to the middle class. The praise of agriculture and medicine and the constant exhortations to cheerfulness, seem to speak of a time when men's thoughts were turned inward with feelings of despondency and perhaps of fatalism. At least the book marks the growth of

that anxious legalism which was conspicuous in the sayings of the later doctors. Life is already imprisoned in rules; religion is degenerating into ritualism: knowledge has taken refuge in schools.

(7) *Baruch*.—This book is remarkable as the only one in the Apocrypha which is formed on the model of the Prophets; and though it is wanting in originality, it presents a vivid reflection of the ancient prophetic fire. The assumed author is undoubtedly the companion of Jeremiah, but the details of the book are inconsistent with the assumption. It exhibits not only historical inaccuracies, but also evident traces of a later date than the beginning of the captivity. The date of its composition is probably about the time of the war of liberation (B.C. 160), or somewhat earlier.

(8) *The Song of the Three Children, Susanna, and Bel and the Dragon*, are brief additions to the canonical book of Daniel.

(9) *The Prayer of Manasses, king of Judah*.—The repentance and restoration of Manasseh¹ furnished the subject of many legendary stories. "His prayer unto his God" was still preserved "in the book of the kings of Israel" when the Chronicles were compiled, and, after this record was lost, the subject was likely to attract the notice of later writers. "The Prayer" in the Apocrypha is the work of one who has endeavored to express, not without true feeling, the thoughts of the repentant king. The writer was well acquainted with the LXX.; but beyond this there is nothing to determine the date at which he lived. The clear teaching on repentance points to a time certainly not long before the Christian era. There is no indication of the place at which the Prayer was written.

(10) *The First and Second Books of Maccabees*.—(a) *The First Book of Maccabees* contains a history of the

1. II Chron. 33:12 ff.

THE JEWISH SACRED BOOKS

patriotic struggle, from the first resistance of Mattathias, to the settled sovereignty and death of Simon, a period of thirty-three years (B.C. 168-135). The opening chapter gives a short summary of the conquests of Alexander the Great, and describes at greater length the oppression of Antiochus Epiphanes. The great subject of the book begins with the enumeration of the Maccabæan family (ii. 1-5), which is followed by an account of the part which the aged Mattathias took in rousing and guiding the spirit of his countrymen (ii. 6-70). The remainder of the narrative is occupied with the exploits of his five sons. Each of the three divisions, into which the main portion of the book thus naturally falls, is stamped with an individual character derived from its special hero. The great marks of trustworthiness are everywhere conspicuous. Victory and failure and despondency are, on the whole, chronicled with the same candor. There is no attempt to bring into open display the working of Providence. The testimony of antiquity leaves no doubt but that the book was first written in Hebrew. Its whole structure points to Palestine as the place of its composition. There is, however, considerable doubt as to its date. Perhaps we may place it between B.C. 120-100. The date and person of the Greek translator are wholly undetermined.

(b) *The Second Book of Maccabees*.—The history of the Second Book of the Maccabees begins some years earlier than that of the First Book, and closes with the victory of Judas Maccabæus over Nicanor. It thus embraces a period of twenty years, from B.C. 180(?) to B.C. 161. For the few events noticed during the earlier years it is our chief authority; during the remainder of the time the narrative goes over the same ground as 1 Macc., but with very considerable differences. The first two chapters are taken up by two letters supposed to be addressed by the Palestinian to the Alexandrine Jews, and by a sketch of the author's

plan, which proceeds without any perceptible break from the close of the second letter. The main narrative occupies the remainder of the book. This presents several natural divisions, which appear to coincide with the 'five books' of Jason on which it was based. The first (c. iii.) contains the history of Heliodorus (cir. B.C. 180). The second (iv.-vii.) gives varied details of the beginning and course of the great persecution (B.C. 175-167). The third (viii.-x. 9) follows the fortunes of Judas to the triumphant restoration of the Temple service (B.C. 166, 165). The fourth (x. 10-xiii.) includes the reign of Antiochus Eupator (B.C. 164-162). The fifth (xiv., xv.) records the treachery of Alcimus, the mission of Nicanor, and the crowning success of Judas (B.C. 162, 161). The writer himself distinctly indicates the source of his narrative—"the five books of Jason of Cyrene" (ii. 23), of which he designed to furnish a short and agreeable epitome for the benefit of those who would be deterred from studying the larger work. His own labor, which he describes in strong terms (ii. 26, 27; comp. xv. 38, 39), was entirely confined to condensation and selection; all investigation of detail he declares to be the peculiar duty of the original historian. Of Jason himself nothing more is known than may be gleaned from this mention of him. The district of Cyrene was most closely united with that of Alexandria. In both the predominance of Greek literature and the Greek language was absolute. The work of Jason must therefore have been composed in Greek; and the style of the epitome proves beyond doubt that the Greek text is the original. It is scarcely less certain that the book was compiled at Alexandria.

The Second Book of Maccabees is not nearly so trustworthy as the First. In the Second Book the groundwork of facts is true, but the dress in which the facts are presented is due in part at least to the narrator. It is not at all improbable that the error with regard to the first cam-

paing of Lysias arose from the mode in which it was introduced by Jason as a prelude to the more important measures of Lysias in the reign of Antiochus Eupator. In other places (as very obviously in xiii. 19 ff.) the compiler may have disregarded the historical dependence of events, while selecting those which were best suited for the support of his theme. The latter half of the book (cc. viii.-xv.) is to be regarded, not as a connected and complete history, but as a series of special incidents from the life of Judas, illustrating the providential interference of God in behalf of His people, true in substance, but embellished in form.

There are two other books of the Maccabees, entitled the *Third* and the *Fourth*, not included in the English Apocrypha. *The Third Book of the Maccabees* contains the history of events which preceded the great Maccabæan struggle. *The Fourth Book of Maccabees* contains a rhetorical narrative of the martyrdom of Eleazar and of the "Maccabæan family," following in the main the same outline as 2 Macc.

6. *The Pseudepigrapha.*

By *Pseudepigrapha* we refer to a group of Jewish books which have never been considered as of equal authority even with the Apocrypha. The title *Pseudepigrapha* literally means "false writings." They are, for the most part, ascribed to such ancient heroes as Enoch, Solomon, Baruch, Ezra, etc., even though by nearly unanimous consent they were written centuries after these men died, during the period approximately 150 B.C. to A.D. 200. Many refer to these books as the *Apocrypha*. In that case they refer to what we have called Apocrypha as the Deutero-canonical books.

Books included in the *Pseudepigrapha* are: (1) *The Book of Jubilees* (legendary additions to Genesis, c. 125 B.C.); (2) *Letter of Aristeas* (giving the legendary story of

NEW TESTAMENT BACKGROUNDS

the production of the LXX); (3) *Books of Adam & Eve* (First to Fourth centuries A.D.); (4) *Martyrdom of Isaiah*; (5) *I Enoch* (First and Second centuries B.C.); (6) *Testament of the Twelve Patriarchs*; (7) *Sibylline Oracles*; (8) *Assumption of Moses*; (9) *II Enoch*; (10) *II Baruch*; (11) *III Baruch*; (12) *IV Esdras*; (13) *Psalms of Solomon*; (14) *Fourth Maccabees*; (15) *The Damascus Document*.

(For questions on the Jewish Religious writings, see numbers 25-51, page 886-887.)

E. THE SYNAGOGUES.

1. Importance of the synagogues.
2. History of the synagogues.
3. Influence of the synagogues.
4. Size and structure of synagogues.
5. Internal arrangement of synagogues.
6. Synagogue officers similar to those of Christian churches.
7. Synagogue ritual largely followed by Christian churches.
8. Judicial functions of synagogues and churches.

1. *Importance of the synagogues.*

The word *synagogue*, which means a "congregation," or "assembly," is used in the New Testament to signify a recognized place of worship. A knowledge of the history and worship of the synagogues is of importance to the student, since they are great characteristic institutions of the later phase of Judaism. More even than the Temple and its services, in the time of which the New Testament treats, they at once represented and determined the religious life of the people. We can not separate them from the most intimate connection with our Lord's life and ministry. In them he worshiped in his youth, and in his manhood. Whatever we can learn of the ritual which then prevailed

tells us of a worship which he recognized and sanctioned; which for that reason, if for no other, though, like the statelier services of the Temple, it was destined to pass away, is worthy of our respect and honor. They were the scenes, too, of no small portion of his work. In them were wrought some of his mightiest works of healing.¹ In them were spoken some of the most glorious of his recorded words;² many more, beyond all reckoning, which are not recorded.

2. *History of the synagogues.*

We know too little of the life of Israel, both before and under the monarchy, to be able to say with certainty whether there was any thing at all corresponding to the synagogues of later date. They appear to have arisen during the exile, in the abeyance of the Temple worship, and to have received their full development on the return of the Jews from captivity. The whole history of Ezra presupposes the habit of solemn, probably of periodic meetings.³ The "ancient days" of which St. James speaks⁴ may, at least, go back so far. After the Maccabæan struggle for independence, we find almost every town or village had its one or more synagogues. Where the Jews were not in sufficient numbers to be able to erect and fill a building, there was the *Proseucha*, or place of prayer, sometimes opened, sometimes covered in, commonly by a running stream or on the sea-shore, in which devout Jews and proselytes met to worship, and, perhaps, to read (Acts 16:13).

3. *Influence of the synagogues.*

It is hardly possible to overestimate the influence of the system thus developed. To it we may ascribe the

1. Mark 1:23; et al.

2. Luke 4:16; et al.

3. Ezra 8:15; Neh. 8:2; 9:1; Zech. 7:5.

4. Acts 15:21.

tenacity with which after the Maccabæan struggle the Jews adhered to the religion of their fathers and never again relapsed into idolatry. The people were now in no danger of forgetting the Law and the external ordinances that hedged it round. If pilgrimages were still made to Jerusalem at the great feasts, the habitual religion of the Jews in, and yet more out of Palestine, was connected much more intimately with the synagogue than with the Temple. Its simple edifying devotion into which mind and heart could alike enter attracted the heathen proselytes who might have been repelled by the sacrifices of the Temple, or would certainly have been driven from it unless they could make up their minds to submit to circumcision.⁵ Here too there was an influence tending to diminish and ultimately almost to destroy the authority of the hereditary priesthood. The services of the synagogue required no sons of Aaron; gave them nothing more than a complimentary precedence. The way was silently prepared for a new and higher order which should rise in "the fullness of time" out of the decay and abolition of both the priesthood and the Temple. In another way, too, the synagogues everywhere prepared the way for that order. Not "Moses" only but "the Prophets" were read in them every Sabbath day and thus the Messianic hopes of Israel, the expectation of a kingdom of Heaven, were universally diffused.

4. *Size and structure of synagogues.*

The size of a synagogue, like that of a church or chapel, varied with the population. We have no reason for believing that there were any fixed laws of proportion for its dimensions like those which are traced in the Tabernacle and the Temple. Its position was, however, determinate. It stood, if possible, on the highest ground, in or near the

5. Acts 21:28.

THE SYNAGOGUE

city to which it belonged. Failing this, a tall pole rose from the roof to render it conspicuous. And its direction too was fixed. Jerusalem was the focus of Jewish devotion; and the synagogue was so constructed that the worshipers as they entered and as they prayed looked toward it. The building was commonly erected at the cost of the district, whether by a church-rate levied for the purpose or by free gifts must remain uncertain. Sometimes it was built by a rich Jew, or even, as in Luke vii. 5, by a friendly proselyte. When the building was finished it was set apart as the Temple had been by a special prayer of dedication. From that time it had a consecrated character. The common acts of life, eating, drinking, reckoning up accounts, were forbidden in it. No one was to pass through it as a short cut. Even if it ceased to be used, the building was not to be applied to any base purpose—might not be turned, *e.g.* into a bath, a laundry, or tannery.

5. Internal arrangement of synagogues.

In the internal arrangement of the synagogue we trace an obvious analogy to the type of the Tabernacle. At the upper or Jerusalem end stood the Ark, the chest which like the older and more sacred Ark contained the Book of the Law. This part of the synagogue was naturally the place of honor. Here were the "chief seats," after which Pharisees and Scribes strove so eagerly,⁶ to which the wealthy and honored worshiper was invited.⁷ Here, too, in front of the Ark, still reproducing the type of the Tabernacle, was the eight-branched lamp, lighted only on the greater festivals. Besides this, there was one lamp kept burning perpetually. Others, brought by devout worshipers, were lighted at the beginning of the Sabbath, *i.e.*, on Friday evening. A little farther toward the middle of the building

6. Matt. 23:6.

7. James 2:2-3.

was a raised platform on which several persons could stand at once, and in the middle of this rose a pulpit in which the Reader stood to read the lesson or sat down to teach. The congregation were divided, men on one side, women on the other, a low partition five or six feet high running between them. Within the Ark, as above stated, were the rolls of the sacred books. The rollers round which they were wound were often elaborately decorated, the cases for them embroidered or enameled, according to their material. Such cases were customary offerings from the rich when they brought their infant children, on the first anniversary of their birthday, to be blessed by the Rabbi of the synagogue.⁸ As part of the fittings we have also to note (1.) another chest for the *Haphtaroth*, or rolls of the prophets. (2.) Alms-boxes at or near the door, after the pattern of those at the Temple, one for the poor of Jerusalem, the other for local charities.⁹ (3) Notice-boards, on which were written the names of offenders who had been "put out of the synagogue." (4) A chest for trumpets and other musical instruments, used at the New Years, Sabbaths, and other festivals.

6. *Synagogue officers similar to those of Christian churches.*

In smaller towns there was often but one Rabbi. Where a fuller organization was possible, there was a college of Elders,¹⁰ presided over by one who was *the ruler of the synagogue*.¹¹ To these elders belonged a variety of syn-

8. The custom, it may be noticed, connects itself with the memorable history of those who "brought young children" to Jesus that he should touch them (Mark 10:13).

9. If this practice existed, as is probable, in the first century, it throws light upon the special stress laid by St. Paul on the collection for the "poor saints" in Jerusalem (1 Cor. 16, etc.). The Christian Churches were not to be behind the Jewish Synagogues in their contributions to the poor of Judea.

10. Gr. "Presbyters." Luke 7:8.

11. Luke 8:41, 49; Acts 18:8.

THE SYNAGOGUE

onyms, each with a special significance. They were *shepherds*¹² watching over their flock, *presidents*, as ruling over it.¹³ With their head, they formed a kind of Chapter, managed the affairs of the synagogue, and possessed the power of excommunicating.

The most prominent functionary in a large synagogue was known as the *Sheliach* (*—legatus*), the officiating minister who acted as the *delegate* of the congregation, and was therefore the chief reader of prayers, etc., in their name. The conditions laid down for this office remind us of St. Paul's rule for the choice of a bishop. He was to be active, of full age, the father of a family, not rich or engaged in business, possessing a "good voice" apt to teach.¹⁴ In him we find, as the name might lead us to expect, the prototype of the "angel of the Church" of Rev. i, 20, ii, 1, etc.

The *Chazzan*, or *servant* of the synagogue,¹⁵ had duties of a lower kind resembling those of the Christian deacon. He was to open the door, to get the building ready for service. For him, too, there were conditions like those for the *legatus*. Like the *legatus* and the *elders*, he was appointed by the imposition of hands. Practically he often acted during the week as school-master of the town or village, and in this way came to gain a prominence which placed him nearly on the same level as the *legatus*.

Besides these, there were ten men attached to every synagogue, whose functions have been the subject-matter of voluminous controversy. They were known as the *Batlanim*, and no synagogue was complete without them. They were to be men of leisure, not obliged to labor for their livelihood, able, therefore, to attend the week-day as well as the Sabbath services. They were, probably, simply a body of men permanently on duty, making up a con-

12. Eph. 4:11.

13. I Tim. 5:17; Heb. 12:7.

14. Cf. I Tim. 3:1-7; Titus 1:6-9.

15. Luke 4:20.

gregation (ten being the minimum number), so that there might be no delay in beginning the service at the proper hours, and that no single worshiper might go away disappointed.

It will be seen at once how closely the organization of the synagogue was reproduced in that of the Christian *Ecclesia*. Here, also, there was the single presbyter-bishop in small towns, a council of presbyters under one head in large cities. The *legatus* of the synagogue appears in the "angel"¹⁶ of the Christian Church. To the elders as such is given the name of Shepherds.¹⁷ They are known also as "leaders," or "those who have the rule over you" (Heb. 13:7).

7. *Synagogue ritual largely followed by Christian churches.*

The ritual of the synagogue was to a large extent an adaptation of the staterly liturgy of the Temple. It will be enough, in this place, to notice in what way the ritual, no less than the organization, was connected with the facts of the New Testament history, and with the life and order of the Christian Church. Here, too, we meet with multiplied coincidences. It would hardly be an exaggeration to say, that the worship of the Church was identical with that of the synagogue, modified (1) by the new truths, (2) by the new institution of the Supper of the Lord, (3) by the spiritual gifts (*charismata*).

From the synagogue came the use of fixed forms of prayer. To that the first disciples had been accustomed from their youth. They had asked their Master to give them a distinctive one, and he had complied with their request,¹⁸ as the Baptist had done before for his disciples,

16. Rev. 1:20; 2:1.

17. Eph. 4:11; I Pet. 5:1.

18. Luke 11:1.

THE SYNAGOGUE

as every Rabbi did for his. The forms might be, and were abused; but for the disciples this was, as yet, the true pattern of devotion, and their Master sanctioned it. To their minds there would seem nothing inconsistent with true heart worship in the recurrence of a fixed order,¹⁹ of the same prayers, hymns, doxologies, such as all liturgical study leads us to think of as existing in the Apostolic Age.

The large admixture of formal teaching in Christian worship, that by which it was distinguished from all Gentile forms of adoration, was derived from the synagogues. "Moses" was "read in the synagogues every Sabbath-day,"²⁰ the whole Law being read consecutively, so as to be completed, according to one cycle, in three years, or according to that which ultimately prevailed, and determined in the existing divisions of the Hebrew text, in the 52 weeks of a single year. The writings of the Prophets were read as second lessons in a corresponding order. They were followed by the *Derash*, "the word of exhortation,"²¹ the exposition, the sermon of the synagogue. The first Christian synagogues, we must believe, followed this order with but little deviation. It remained for them before long to add "the other Scriptures," which they had learned to recognize as more precious even than the Law itself, the "prophetic word" of the New Testament. The synagogue use of Psalms again, on the plan of selecting those which had a special fitness for special times, answered to that which appears to have prevailed in the Church of the first three centuries.

The conformity extends also to the times of prayer. In the hours of service this was obviously the case. The third, sixth, and ninth hours were, in the times of the New Testament,²² and had been probably for some time be-

19. I Cor. 14:40.

20. Acts 15:21.

21. Acts 13:15.

22. Acts 3:1; 10:3, 9.

fore,²³ the fixed times of devotion. The same hours, it is well known, were recognized in the Church of the second, probably in that of the first century also.

The sacred days belonging to the two systems seem, at first, to present a contrast rather than a resemblance; but here too there is a symmetry which points to an original connection. The solemn days of the synagogue were the second, the fifth, and the seventh, the last or Sabbath being the conclusion of the whole. In whatever way the change was brought about, the transfer of the sanctity of the Sabbath to the Lord's Day involved a corresponding change in the order of the week, and the first, the fourth, and the sixth became to the Christian society, what the other days had been to the Jewish.

8. *Judicial functions of synagogues and churches.*

The language of the New Testament shows that the officers of the synagogue exercised in certain cases a judicial power. The synagogue itself was the place of trial;²⁴ even, strange as it may seem, of the actual punishment of scourging.²⁵ They do not appear to have had the right of inflicting any severer penalty, unless, under this head, we may include that of excommunication, or "putting a man out of the synagogue,"²⁶ placing him under an anathema,²⁷ "delivering him to Satan."²⁸ In some cases they exercised the right, even outside the limits of Palestine, of seizing the persons of the accused, and sending them in chains to take their trial before the Supreme Council at Jerusalem.²⁹

Here, also, we trace the outline of a Christian institution. The Church, either by itself or by appointed dele-

23. Psalm 55:17; Daniel 6:10.

24. Luke 12:11; 21:12.

25. Matt. 10:17; Mark 13:9.

26. John 12:42; 16:2.

27. I Cor. 16:22; Gal. 1:8-9.

28. I Cor. 5:5; I Tim. 1:20.

29. Acts 9:2; 22:5.

JEWISH SECTS

gates, was to act as a Court of Arbitration in all disputes among its members. The elders of the Church were not, however, to descend to the trivial disputes of daily life. For these, any men of common sense and fairness, however destitute of official honor and position, would be enough.³⁰ For the elders, as for those of the synagogue, were reserved the graver offenses against religion and morals. In such cases they had power to excommunicate, to "put out of" the Church, which had taken the place of the synagogue, sometimes by their own authority, sometimes with the consent of the whole society.³¹

(For questions on the Synagogues, see numbers 52-58, page 888.)

F. SECTS OF THE JEWS.

1. *Origin and names of the Jewish sects.*

The division of the Jewish people into religious parties following teachers of different schools of theological opinion is a phenomenon peculiar to the age subsequent to the Captivity. In the ritualism of the Mosaic law there was scarcely any scope left for opinion, and, at all events, we find little if any trace of a tendency to discuss the foundations of the Law on the one hand, or to speculate on its developments. The actual division was a stern conflict between obedience to the law of God, and the open rebellion of idolatry; between prophets truly inspired by Jehovah, and those who spoke falsely in his name; between the fidelity of religious patriotism, and the parties that were ever for leaning to Egypt and Assyria.

The cessation of idolatry, and the more thoughtful and spiritual character which the Jewish religion assumed after the Captivity, gave freer scope to the speculative element.

30. I Cor. 6:1-8.

31. I Cor. 5:4.

The contact with foreign modes of thought must also have had no small influence; but still it is one of the obscurest parts of this difficult subject to trace back any specific tenets of the different parties that were formed during the Asmonæan period, to oriental ideas imbibed during the Captivity, on the one hand, or to Hellenistic philosophy on the other. Especially must we be careful to confound the "opposition party" in theology—the Sadducees—with the unpatriotic Hellenizers who were hateful alike to all who had any regard to the law of Moses and the worship of Jehovah.

In one point, at least, there was a resemblance between the religious parties of the Jews and the philosophic schools of the Greeks: the name used to refer to Greek philosophic schools (*heresy*) was applied to the Jewish religious parties. This Greek word, roughly transliterated *heresy* in English, is often translated as *sect*, a word derived from Latin, meaning a *beaten path*, or *way*. This term *way* is often applied to the Christians in the N.T. (Acts 9:2).

We read in the *Acts of the Apostles* (5:17) of "the *sect* (or *heresy*) of the Sadducees," and "the *sect* of the Pharisees" (15:5). When St. Paul was charged with being "a ringleader of the *sect* (*heresy*) of the Nazarenes," his reply proves that he knew the term to be used in an opprobrious sense:—"This I confess unto thee, after *the way which they call heresy*, so worship I the God of my fathers;" and the Apostle himself, as well as Peter, uses the term in that condemnatory sense in which it has passed into ecclesiastical language.

The chief sects among the Jews were the PHARISEES, the SADDUCEES, and the ESSENES; who may be described respectively as the *Formalists*, the *Free-thinkers*, and the *Puritans*; but it must be remembered that such brief general characteristics are of necessity extremely vague. Of

1. Acts 24:5, 14; 28:22.

the *Herodians* who can not properly be called a *sect* we have already had occasion to speak.

2. *The Pharisees.*

- a. Their name and origin.
- b. The Pharisees' fundamental doctrine: belief in an oral law.
- c. Pharisees' belief in a future life.
- d. The Pharisees' proselytizing spirit.

a. *Their Name and Origin.*

The PHARISEES are so called from *Perishim*, the Aramaic form of the Hebrew word *Perushim*, "separated." The name does not occur either in the Old Testament or in the Apocrypha; but it is usually considered that the Pharisees were essentially the same with the Assidæans (i.e. *chasidim*—godly men, saints) mentioned in the Books of Maccabees.

A knowledge of the opinions and practices of this party at the time of Christ is of great importance for entering deeply into the genius of the Christian religion. A cursory perusal of the Gospel is sufficient to show that Christ's teaching was in some respects thoroughly antagonistic to theirs. He denounced them in the bitterest language.² Indeed, it is difficult to avoid the conclusion, that his repeated denunciations of the Pharisees mainly exasperated them into taking measures for causing his death; so that in one sense he may be said to have shed his blood and to have laid down his life in protesting against their practice and spirit.³ Hence, to understand the Pharisees is by contrast an aid toward understanding the spirit of uncorrupted Christianity.

2. See Matt. 15:7, 8; 23:5, 13, 14, et al.

3. Luke 11:53-54.

b. *The Pharisees' fundamental doctrine:
belief in an Oral Law.*

The doctrines of the Pharisees are contained in the *Mishna*, of which an account has been already given. It has been there shown that the fundamental principle of the Pharisees is that by the side of the written law there was *an oral law to complete and to explain the written law*, given to Moses on Mount Sinai, and transmitted by him by word of mouth.

It is not to be supposed that all the traditions which bound the Pharisees were believed to be revelations to Moses on Mount Sinai. In addition to such revelations, which were not disputed, there were three other classes of traditions. 1st. Opinions on disputed points, which were the result of a majority of votes. 2dly. Decrees made by prophets and wise men in different ages, in conformity with a saying attributed to the men of the Great Synagogue, "Be deliberate in judgment; train up many disciples; and *make a fence for the law.*" These carried prohibitions farther than the written law or oral law of Moses in order to protect the Jewish people from temptations to sin or pollution. 3dly. Legal decisions of proper ecclesiastical authorities on disputed questions. However, although in these several ways *all* the traditions of the Pharisees were not deemed direct revelations from Jehovah, there is no doubt that all became invested, more or less, with a peculiar sanctity; so that, regarded collectively, the study of them and the observance of them became as imperative as the study and observance of the precepts in the Bible.

Viewed as a whole, they treated men like children, formalizing and defining the minutest particulars of ritual observances. The expressions of "bondage," of "weak and beggarly elements," and of "burdens too heavy for men to bear," faithfully represent the impression produced by their multiplicity. An elaborate argument might be ad-

vanced for many of them individually, but the sting of them consisted in their aggregate number which would have a tendency to quench the fervor and the freshness of a spiritual religion. Particularly were their laws about the keeping of the sabbath day detailed and hair-splitting and burdensome.

In order to observe regulations on points of this kind, the Pharisees formed a kind of society. A member was called a *chaber*, and those among the middle and lower classes who were not members were called "the people of the land," or the vulgar. Each member pledged, in the presence of three other members, that he would remain true to the laws of the association. The conditions were various. One of transcendent importance was that a member should refrain from every thing that was not tithed.⁴ The Mishna says, "He who undertakes to be *trustworthy* (a word with a technical Pharisaical meaning) tithes whatever he eats, and whatever he sells, and whatever he buys, and *does not eat and drink with the people of the land.*" This was a point of peculiar delicacy, for the portion of produce reserved as tithes for the priests and Levites was *holy*, and the enjoyment of what was holy was a deadly sin. Hence a Pharisee was bound, not only to ascertain as a buyer whether the articles which he purchased had been duly tithed, but to have the same certainty in regard to what he ate in his own house and when taking his meals with others. And thus Christ, in eating with publicans and sinners, ran counter to the first principles, and shocked the most deeply-rooted prejudices of Pharisaism; for, independently of other obvious considerations, he ate and drank with "the people of the land," and it would have been assumed as undoubted that he partook on such occasions of food which had not been duly tithed.

Perhaps some of the most characteristic laws of the

4. Cf. Matt. 23:23; Luke 18:12.

Pharisees related to what was clean and unclean. According to the Levitical law, every unclean person was cut off from all religious privileges and was regarded as defiling the sanctuary of Jehovah.⁵ On principles precisely similar to those of the Levitical laws,⁶ it was possible to incur these awful religious penalties either by *eating* or by *touching* what was unclean in the Pharisaical sense. One point alone raised an insuperable barrier between the free social contact of Jews and other nations. This point is, "that *any thing* slaughtered by a heathen should be deemed unfit to be eaten, like the carcass of an animal that had died of itself, and like such carcass should pollute the person who carried it." On the assumption that under such a concept all animals used for food would be killed by Jewish slaughterers, the most minute regulations are laid down for their guidance. In reference, likewise, to *touching* what is unclean, the Mishna abounds with prohibitions and distinctions no less minute; and by far the greatest portion of the 6th and last "Order" relates to impurities contracted in this manner. Referring to the "Order" for details, it may be observed that to any one fresh from the perusal of them, and of others already adverted to, the words, "Touch not, taste not, handle not," seem a correct but almost a pale summary of their drift and purpose;⁷ and the stern antagonism becomes vividly visible between them and Him who proclaimed boldly that a man was defiled not by any thing he ate, but by the bad thoughts of the heart alone;⁸ and who even when the guest of a Pharisee pointedly abstained from washing his hands before a meal in order to rebuke the superstition which attached a moral value to such a ceremonial act.⁹

5. Num. 19:20.

6. Lev. 20:25; 22:4-7.

7. Col. 2:21.

8. Matt. 15:11.

9. Luke 11:37-40.

JEWISH SECTS

It is proper to add, that it would be a great mistake to suppose that the Pharisees were wealthy and luxurious, much more that they had degenerated into the vices which were imputed to some of the Roman popes and cardinals during the 200 years preceding the Reformation. Josephus compared the Pharisees to the sect of the Stoics. He says that they lived frugally, in no respect giving in to luxury, but that they followed the leadership of reason in what it had selected and transmitted as a good.¹⁰ With this agrees what he states in another passage that the Pharisees had so much weight with the multitude that if they said any thing against a king or a high-priest they were at once believed;¹¹ for this kind of influence is more likely to be obtained by a religious body over the people through austerity and self-denial than through wealth, luxury and self-indulgence. Although there would be hypocrites among them, it would be unreasonable to charge all the Pharisees as a body with hypocrisy in the sense wherein we at the present day use the word. But at any rate they must be regarded as having been some of the most intense *formalists* whom the world has ever seen; and looking at the average standard of excellence among mankind, it is nearly certain that men whose lives were spent in the ceremonial observances of the Mishna would cherish feelings of self-complacency and spiritual pride not justified by intrinsic moral excellence. The supercilious contempt toward the poor publican and toward the tender penitent love that bathed Christ's feet with tears would be the natural result of such a system of life.

It was alleged against them on the highest spiritual authority that they "made the word of God of no effect by their traditions." The evasions connected with Corban are well known, and others equally striking might be added from the Mishna.

10. *Ant.* xviii, 1, 3.

11. *Ant.* xiii, 10, 5.

NEW TESTAMENT BACKGROUNDS

c. Pharisees' belief in a future life.

One of the fundamental doctrines of the Pharisees was a belief in a future state. They appear to have believed in a resurrection of the dead, very much in the same sense as the early Christians. This is in accordance with St. Paul's statement to the chief priests and council¹² that he was a Pharisee, the son of a Pharisee, and that he was called in question for the hope and resurrection of the dead; and it is likewise almost implied in Christ's teaching which does not insist on the doctrine of a future life as any thing new, but assumes it as already adopted by his hearers, except by the Sadducees, although he condemns some unspiritual conceptions of its nature as erroneous.¹³

d. The Pharisees' proselytizing spirit.

In reference to the *spirit of proselytism* among the Pharisees, there is indisputable authority for the statement that it prevailed to a very great extent at the time of Christ;¹⁴ and attention is now called to it on account of its probable importance in having paved the way for the early diffusion of Christianity. Through kidnapping,¹⁵ through leading into captivity by military incursions and victorious enemies,¹⁶ through flight,¹⁷ through commerce,¹⁸ and probably through ordinary emigration, Jews at the time of Christ had become scattered over the fairest portions of the civilized world. On the day of Pentecost, Jews are said to have been assembled with one accord in one place at Jerusalem "from every region under heaven." Moreover, the then existing regulations or customs of synagogues afforded facilities which do not exist now, either in

12. Acts 23:6.

13. Matt. 22:30; Mark 12:25; Luke 20:34-36.

14. Matt. 23:15.

15. Joel 3:6.

16. II K. 17:6.

17. Jer. 43:4-7.

18. Josephus, *Ant.* xx, 2, 3.

JEWISH SECTS

synagogues or Christian Churches, for presenting new views to a congregation.¹⁹ Under such auspices the proselytizing spirit of the Pharisees inevitably stimulated a thirst for inquiry and accustomed the Jews to theological controversies. Thus there existed precedents and favoring circumstances for efforts to make proselytes, when the greatest of all missionaries, a Jew by race, a Pharisee by education, a Greek by language, and a Roman citizen by birth, preaching the resurrection of Jesus to those who are the most part already believed in the resurrection of the dead, confronted the elaborate ritual-system of the written and oral law by a pure spiritual religion; and thus obtained the co-operation of many Jews themselves in breaking down every barrier between Jew, Pharisee, Greek, and Roman, and in endeavoring to unite all mankind by the brotherhood of a common Christianity.

(For questions about the Pharisees, see numbers 61-67, page 887.)

3. *The Sadducees.*

- a. Their name and origin.
- b. The Sadducees fundamental doctrine: denial of an Oral Law.
- c. Sadducees deny a resurrection of the dead.
- d. Sadducees believe in free will.
- e. The Sadducees supposed rejection of all scripture except the Pentateuch.
- f. Rapid disappearance of the Sadducees.

a. *Their name and origin.*

Although frequently mentioned in the New Testament in conjunction with the Pharisees, they do not throw such vivid light on the real significance of Christianity as the Pharisees do. Except on one occasion, when they united with the Pharisees in insidiously asking for a sign from

19. Acts 17:2; Luke 4:16.

heaven,¹ Christ never assailed the Sadducees with the same bitter denunciations which he uttered against the Pharisees. They have not been so influential as the Pharisees in the world's history; but still they deserve attention as representing Jewish ideas before the Pharisees became triumphant and as illustrating one phase of Jewish thought at the time of the promulgation of Christianity.

The origin of their name is involved in great difficulties. The Hebrew word by which they are called in the Mishna is *Tsedikim*, the plural of *Tsadok*, which undoubtedly means "just," or "righteous," but which is never used in the Bible except as a proper name, and in the English Version is always translated "Zadok"² The most obvious translation of the word, therefore, is to call them Zadoks or Zadokites; and a question would then arise as to why they were so called. The ordinary Jewish statement is that they are named from a certain Zadok, a disciple of that Antigonus of Socho, who is mentioned in the Mishna as having received the oral law from Simon the Just, the last of the men of the Great Synagogue; but it is certain that this statement must be rejected. As recourse is had to conjecture, the first point to be considered is whether the word is likely to have arisen from the meaning of "righteousness," or from the name of an individual. This must be decided in favor of the latter alternative inasmuch as the word Zadok as we have already seen never occurs in the Bible except as a proper name; and then we are led to inquire as to who the Zadok of the Sadducees is likely to have been. Now, there was one Zadok of transcendent importance, and only one: viz., the priest who acted such a prominent part at the time of David and who declared in favor of Solomon when Abiathar took the part of Adonijah as successor of the throne.³ His line of priests

1. Matt. 16:1, 4, 6.

2. II K. 15:33.

3. I K. 1:32-45.

JEWISH SECTS

appears to have had decided pre-eminence in subsequent history. Thus, in Ezekiel's prophetic vision of the future Temple, "the sons of Zadok," and "the priests the Levites of the seed of Zadok" are spoken of with peculiar honor as those who kept the charge of the sanctuary of Jehovah when the children of Israel went astray.⁴ From this it has been conjectured that the Sadducees or Zadokites were originally identical with the sons of Zadok, and constituted what may be termed a kind of sacerdotal aristocracy. To these were afterward attached all who for any reason reckoned themselves as belonging to the aristocracy; such, for example, as the families of the high-priests who had obtained consideration under the dynasty of Herod. These were for the most part judges, and individuals of the official and governing class.

The expression "the sons of Zadok" occurs frequently in the Dead Sea manuscripts from Qumran⁵ as a title for the faithful members of that colony as contrasted with the apostates. However, these writings give no real clues as to the origin of the name *Sadducee*, or as to which Zadok the name was derived from.

b. *The Sadducees' fundamental doctrine: Denial of an Oral Law.*

The leading tenet of the Sadducees was *the denial of the leading tenet of their opponents*. As the Pharisees asserted, so the Sadducees denied, that the Israelites were in possession of an Oral Law transmitted to them by Moses. In opposition to the Pharisees, they maintained that the written law alone was obligatory on the nation as of divine authority.

It must not be assumed that the Sadducees, because

4. Ezek. 40:46.

5. Wm. F. LaSor, *Dead Sea Scrolls and the Christian Faith* (Moody, 1962), p. 162ff.

they rejected a Mosaic Oral Law, rejected likewise all traditions and all decisions in explanation of passages in the Pentateuch. Although they protested against the assertion that such points had been divinely settled by Moses, they probably, in numerous instances, followed practically the same traditions as the Pharisees.

c. *Sadducees deny a resurrection of the dead.*

The second distinguishing doctrine of the Sadducees, the *denial of man's resurrection after death*, followed in their conceptions as a logical conclusion from their denial that Moses had revealed to the Israelites the Oral Law. For on a point so momentous as a second life beyond the grave, no religious party among the Jews would have deemed themselves bound to accept any doctrine as an article of faith, unless it had been proclaimed by Moses, their great legislator; and it is certain that in the written Law of the Pentateuch there is a total absence of any assertion by Moses of the resurrection of the dead. This fact is presented to Christians in a striking manner by the well-known words of the Pentateuch which are quoted by Christ in argument with the Sadducees on this subject.⁶ It can not be doubted that in such a case Christ would quote to his powerful adversaries the most cogent text in the Law; and yet the text actually quoted does not do more than suggest an *inference* on this great doctrine. It is true that in other parts of the Old Testament there are individual passages which express a belief in a resurrection, such as in Is. xxvi. 19, Dan. xii. 2, Job xix. 26, and in some of the Psalms; and it may at first sight be a subject of surprise that the Sadducees were not convinced by the authority of those passages. But although the Sadducees regarded the books which contained these passages as sacred, it is more

6. Ex. 3:6, 16; Mark 12:26-27.

than doubtful whether any of the Jews regarded them as sacred in precisely the same sense as the written Law.

In connection with the disbelief of a resurrection by the Sadducees, it is proper to notice the statement,⁷ that they likewise denied there was "angel or spirit." A perplexity arises as to the precise sense in which this denial is to be understood. Angels are so distinctly mentioned in the Pentateuch and other books of the Old Testament that it is hard to understand how those who acknowledged the Old Testament to have divine authority could deny the existence of angels. The two principal explanations which have been suggested are either that the Sadducees regarded the angels of the Old Testament as transitory, unsubstantial representations of Jehovah, or that they disbelieved, not the angels of the Old Testament, but merely the angelical system which had become developed in the popular belief of the Jews after their return from the Babylonian captivity. Either of these explanations may possibly be correct; and the first, although there are numerous texts to which it did not apply, would have received some countenance from passages wherein the same divine appearance, which at one time is called the "angel of Jehovah," is afterward called simply "Jehovah."⁸

d. *Sadducees believe in free will.*

Josephus states that the Sadducees believed in the *freedom of the will*, which the Pharisees denied. Possibly the great stress laid by the Sadducees on the freedom of the will may have had some connection with their forming such a large portion of that class from which criminal judges were selected. They would be more practical in judging human conduct than those who felt that much of man's

7. Acts 23:8.

8. Gen. 16:7, 13; 22:11, 12; 31:1, 16; Ex. 3:2, 4; Judges 6:14, 22; 13:18, 22.

conduct was controlled by powers outside of himself (Josephus, Ant. xx, 9, 1).

e. *The Sadducees' supposed rejection of all scripture except the Pentateuch.*

Some of the early Christian writers attribute to the Sadducees the rejection of all the Sacred Scriptures except the Pentateuch. Such rejection, if true, would undoubtedly constitute a most important additional difference between the Sadducees and Pharisees. The statement of these Christian writers is, however, now generally admitted to have been founded on a misconception of the truth, and it seems to have arisen from a confusion of the Sadducees with the Samaritans.

f. *Rapid disappearance of Sadducees.*

An important fact in the history of the Sadducees is their *rapid disappearance from history after the first century*, and the subsequent predominance among the Jews of the opinions of the Pharisees. Two circumstances, indirectly but powerfully, contributed to produce this result: 1st. The state of the Jews after the capture of Jerusalem by Titus; and 2dly. The growth of the Christian religion. As to the first point, it is difficult to overestimate the consternation and dismay which the destruction of Jerusalem occasioned in the minds of sincerely religious Jews. In this their hour of darkness and anguish, they naturally turned to the consolations and hopes of a future state; and the doctrine of the Sadducees that there was nothing beyond the present life would have appeared to them cold, heartless, and hateful. Again, while they were sunk in the lowest depths of depression, a new religion which they despised as a heresy and a superstition was gradually making its way among the subjects of their de-

JEWISH SECTS

tested conquerors, the Romans. One of the causes of its success was undoubtedly the vivid belief in the resurrection of Jesus, and a consequent resurrection of all mankind, which was accepted by its heathen converts with a passionate earnestness, of which those who at the present day are familiar from infancy with the doctrine of the resurrection of the dead can form only a faint idea. To attempt to check the progress of this new religion among the Jews by an appeal to the temporary rewards and punishments of the Pentateuch would have been as idle as an endeavor to check an explosive power by ordinary mechanical restraints. Consciously, therefore, or unconsciously, many circumstances combined to induce the Jews who were not Pharisees but who resisted the new heresy to rally round the standard of the Oral Law, and to assert that their holy legislator, Moses, had transmitted to his faithful people by word of mouth, although not in writing, the revelation of a future state of rewards and punishments.

(For questions about the Sadducees, see numbers 68-74, page 888-889.)

4. *The Essenes.*

- a. Identification of the Essenes; The Qumran colony.
- b. Origin and history of the Essenes.
- c. Writings of the Essenes.
- d. The relation of Essenes to Christianity.
- e. Practices of the Essenes.

a. *Identification of the Essenes; The Qumran colony.*

The Essenes were a small, very strict, semi-monastic sect which formed colonies apart from the rest of the Jews, whom they generally regarded as hopelessly corrupted.

The number of the Essenes is roughly estimated by Philo at 4000, and Josephus says that there were "more than

4000" who observed their rule.¹ Their best known settlements were on the N.W. shore of the Dead Sea, but others lived in scattered communities throughout Palestine, and perhaps, also, in cities.

This sect is represented by Josephus as combining the ascetic virtues of the Pythagoreans and Stoics with a spiritual knowledge of the Divine Law. The origin of their name is quite uncertain, and the various derivations that have been proposed for it are all more or less open to objection.

The Dead Sea colony at Qumran, which produced the famous Dead Sea scrolls, was probably an Essene colony, although their writings indicate some differences from the Essene practices as described by Josephus.² The Essenes generally condemned marriage; the Qumran colony did not. The Essenes would not use oaths, but the Qumranians did. The Essenes repudiated slavery, but the Qumranians did not. These differences suggest that the Qumranians may have been a splinter group within the Essenes, or that Josephus may not have had all his facts right about the Essenes. Some even suggest that the Qumranians were a different sect from the Essenes; but this seems unlikely because there is hardly space enough in the area around the N.W. Dead Sea area for both the Qumran settlement and another Essene settlement to which Josephus refers.

b. *Origin and history of Essenes.*

The growth of Essenism was a natural result of the religious feeling which was called out by the circumstances of the Greek dominion; and it is easy to trace the process by which it was matured. From the Maccabæan age there was a continuous effort among the stricter Jews to attain an absolute standard of holiness. Each class of devotees

1. Josephus, *Ant.* xviii, 2, 5.

2. Wm. LaSor, *Dead Sea Scrolls and the Christian Faith* (Moody, 1962), p. 177ff.

JEWISH SECTS

was looked upon as practically impure by their successors, who carried the laws of purity still further; and the Essenes stand at the extreme limit of the mystic ascetism which was thus gradually reduced to shape. The associations of the "Scribes and Pharisees," "*the companions, the wise,*" gave place to others bound by a more rigid rule; and the rule of the Essenes was made gradually stricter. Judas, the earliest Essene who is mentioned (c. 110 B.C.), appears living in ordinary society.³ But by a natural impulse, the Essenes withdrew from the dangers and distractions of business. From the cities they retired to the wilderness, to realize the conceptions of religion which they formed, but still they remained on the whole true to their ancient faith. To the Pharisees they stood nearly in the same relation as that in which the Pharisees themselves stood with regard to the mass of the people. The differences lay mainly in rigor of practice, and not in articles of belief.

The traces of the existence of Essenes in common society are not wanting, nor confined to individual cases. Not only was a gate at Jerusalem named from them,⁴ but a later tradition mentions the existence of a congregation there which devoted "one-third of the day to study, one-third to prayer, and one-third to labor." Those, again, whom Josephus speaks of as allowing marriage, may be supposed to have belonged to such bodies as had not yet withdrawn from intercourse with their fellow-men. But the practice of the extreme section was afterward regarded as characteristic of the whole class, and the isolated communities of Essenes furnished the type which is preserved in the popular descriptions.

Information is lacking as to the exact time when the Qumran colony withdrew to its monastery near the N.W.

3. Josephus, *Wars* i, 3, 5.

4. Josephus, *Wars* v, 4, 2.

JEWISH SECTS

corner of Dead Sea. LaSor estimates that it was about 196 B.C. when the first group settled there.⁵

A possible occasion for further withdrawal of devout Jews to this colony is suggested in the *Habakkuk Commentary*, one of the documents found in the Dead Sea caves in 1946-47. This document mentions the "house of Absalom," who were silent at the reproof of the Teacher of Righteousness, and did not help him against the Man of the Lie.⁶ The identity of the Teacher of Righteousness and the Man of the Lie are both uncertain; but LaSor suggests that the Teacher of Righteousness may have been the good priest Onias III (198-171 B.C.). In the time of Onias, Simon, the treasurer of the temple, instigated an attempt to seize the treasures of the temple; perhaps he was the Man of the Lie. At any rate, it appears that one group of the priests, the formalists, or Sanhedrin, did not speak against the outrage. Thereupon the "true sons of Zadok" (the Qumran seceders) moved out of the formalist group in protest, and started their own colony.

Later withdrawals to Essene colonies could well have occurred during the time of Alexander Jannaeus. The record of his shocking wars with his own countrymen can be read earlier in this book. Probably in the time of Herod the Great others withdrew to the Dead Sea.

At Qumran the colony occupied itself with tanning leather for writing purposes, copying scrolls; hours of study of the Law, prayer, and anticipation of the end of the age, which they regarded as very near because of their nation's society had become intolerably wicked.

Josephus tells that in A.D. 68 Vespasian brought his Roman army across Palestine from Caesarea to Jericho. The people of Jericho resisted briefly, but then fled to the mountains westward. Qumran is very near (7 miles)

5. LaSor, *Op. cit.*, p. 225.

6. 1Q Hab. 5:9-10. LaSor, *op. cit.*, 223.

to Jericho. It would appear that when the inhabitants of Jericho fled that the Qumranians also fled, but only after they had placed their precious scrolls in earthen jars and hidden them in nearby caves to be retrieved when they returned. Vespasian left to return to Rome. But his son Titus came to Jericho, and marched the army up to Jerusalem to besiege it. The fact that a coin of the Roman Tenth Legion was found at Qumran suggests that Titus must have destroyed the Qumran buildings before marching on up to Jerusalem. With Roman troops stationed all around the area, the Qumran residents, if they survived at all, never returned to get their scrolls. They were found by accident in the winter of 1946-47 by an Arab shepherd boy.

c. *Writings of the Essenes*

Scrolls and fragments of writings have been found in eleven caves in the Qumran vicinity. The fragments number in tens of thousands, some no larger than a fingernail, and others much larger. The principal scrolls number seven, or eight, with the publication of a "Temple Scroll,"⁷ obtained by the Israelis after the Six Days' War. These seven scrolls include two manuscripts of Isaiah; a commentary on Habakkuk chapters one and two; the so-called Manual of Discipline, or Sectarian Document, which gives rules and procedures for the members of the colony; an allegorical work called *The War of the Sons of Light against the Children of Darkness* (or *Order of Warfare*); a collection of Thanksgiving Hymns; and the *Genesis Apocryphon*, a combination of Biblical and legendary information relating to Genesis 12-15.

Besides these materials, fragments of every O.T. book except Esther have been identified among the finds. Also fragments of nearly all of the apocryphal books; and frag-

7. *Biblical Archaeologist*, Dec. 1967, p. 185 ff.

ments of Mark, John, Acts, Matthew, Luke, and Colossians. These N.T. documents possibly found their way to Qumran by Christian settlers who stayed at Qumran briefly after the Roman destruction of Jerusalem. Also a great many other fragments of other books, some of the Pseudepigrapha, and some previously unknown writings were found. Not all the fragments have yet been identified, but it appears that the total number of manuscripts originally left at Qumran may number six to eight hundred. One of the rooms in the ruins at Qumran contained a writing table with inkwells containing dried up black ink and pens. Certainly the Qumranians were a literary people.

d. *The relation of the Essenes to Christianity.*

Certain popular books in recent years have alleged that the Dead Sea scrolls have provided us with knowledge about the "source" of many Christian beliefs, terms, and practices: the Essenes are declared to have given to John the Baptist or to Jesus himself such ideas as "the new covenant," "sons of light," "the community," "the suffering Messiah," "baptism," "communion," and many other concepts.

These allegations must be treated as speculation, to say the most for them. Many of the terms used both in Christian writings and in the Qumran writings were drawn from the Old Testament which is the predecessor of both Christianity and Qumran. Therefore, the fact that certain expressions are found both in the New Testament and in the Dead Sea manuscripts does not prove that they came from the Dead Sea colony.

Furthermore, there are many expressions in the Dead Sea documents that are antagonistic to Christian doctrine. The Qumranians were taught to love all the children of

light, but to HATE all the children of darkness.⁸ They declared they would show no compassion to any that turn from the way.⁹ They regarded themselves as having direct access to God, and needed no intermediary among them (such as Christ Jesus).¹⁰ They had burdensome detailed Sabbath rules, such as Jesus condemned in the Pharisees.¹¹ With such great differences as these between themselves and the N.T. doctrine, it is hard to see how the Qumranians could have been the source of N.T. faith and practices.

Nearly all of the principal scholars working on the Dead Sea manuscripts deny categorically that there is any indication that the Essene colony at Qumran contributed in any way to the beliefs of Christendom. For example, Theodor H. Gaster, a translator of the Dead Sea documents, after listing twelve parallels between the N.T. and the Qumran documents says that it must be stated emphatically that the community envisaged in the Dead Sea Scrolls and translated into reality at Qumran, is in no sense Christian, and holds none of the fundamental theological doctrines of the Christian faith.¹² Similarly Rabbi Samuel Sandmel says that the Dead Sea Scrolls have no bearing on the origin of the Christian gospel. For further confirmation of the fact that most scholars deny connection between the N.T. doctrines and the Qumran beliefs, see Wm. LaSor, *Dead Sea Scrolls and the Christian Faith*, p. 207 ff.

e. *Practices of the Essenes*

These were regulated by strict rules, analogous to those of the monastic institutions of a later date. The candidate for admission first passed through a year's novitiate, in which he received, as symbolic gifts, an axe, an apron, and

8. Theodor H. Gaster, *The Dead Sea Scriptures in English Translation*, Doubleday, 1964, p. 46.

9. Gaster, *Op. cit.*, 129.

10. *Ibid*, 159.

11. *Ibid*, 88.

12. *Ibid*, 19.

a white robe, and gave proof of his temperance by observing the ascetic rules of the order. At the close of this probation, his character was submitted to a fresh trial of two years, and meanwhile he shared in the lustral rites of the initiated, but not in their meals. The full membership was imparted at the end of this second period, when the novice bound himself by "awful oaths"—though oaths were absolutely forbidden at all other times—to observe piety, justice, obedience, honesty, and secrecy, "preserving alike the books of their sect, and *the names of the angels.*"¹³

The order itself was regulated by an internal jurisdiction. Excommunication was equivalent to a slow death, since an Essene could not take food prepared by strangers for fear of pollution. All things were held in common, without distinction of property or house; and special provision was made for the relief of the poor. Self-denial, temperance, and labor—especially agriculture—were the marks of the outward life of the Essenes; purity and divine communion the objects of their aspiration. Slavery, war, and commerce were alike forbidden; and, according to Philo, their conduct generally was directed by three rules, "the love of God, the love of virtue, and the love of man."

(For questions about the Essenes, see numbers 75-82, page 889.)

5. *The Scribes.*

- a. Origin of the scribes' office.
- b. Importance of the scribe's work.
- c. Evil development with the scribal office.
- d. The schools of Hillel and Shammai. Training for and advancement within the scribe's office.

a. *Origin of the scribes' office*

THE SCRIBES, though not a sect of the Jews, may be

13. Josephus, *Wars*, ii, 817.

conveniently treated of in this place on account of their intimate connection with the Pharisees. The words "Scribes" and "Pharisees" are bound together in the Gospels by the closest possible alliance.¹ The Scribes, who were originally the secretaries of the king, became in course of times a learned class, students and interpreters of the law. The seventy years of the Captivity gave a fresh glory to the name. The exiles would be anxious above all things to preserve the sacred books, the laws, the hymns, the prophecies of the past. To know what was worth preserving, to transcribe the older Hebrew documents accurately, when the spoken language of the people was passing into Aramaic, to explain what was hard and obscure—this was what the necessities of the time demanded. The man who met them became emphatically "*Ezra the Scribe*," the priestly functions falling into the background, as the priestly order itself did before the Scribes as a class. The words of *Ezr. vii. 10* describe the high ideal of the new office. The Scribe is "to seek the law of the Lord and to do it, and to teach in Israel statutes and judgments." Of the time that followed we have but scanty records. The Scribes' office apparently became more and more prominent. They appear as a distinct class, "the families of the Scribes," with a local habitation.²

b. *Importance of the scribe's work.*

It is characteristic of the Scribes of this period that, with the exception of *Ezra* and *Zadok*,³ we have no record of their names. A later age honored them collectively as the men of the Great Synagogue. Never, perhaps, was so important a work done so silently. They devoted themselves to the careful study of the text, and laid down rules for transcribing it with the most scrupulous precision. A

1. *Matt. 23 passim.*

2. *I Ch. 2:55.*

saying is ascribed to Simon the Just (300-290 B.C.), the last of the succession of the men of the Great Synagogue, which embodies the principle on which they acted, and enables us to trace the growth of their system. "Our fathers have taught us," he said, "three things: to be cautious in judging, to train many scholars, and to set a fence about the Law." They wished to make the Law of Moses the rule of life for the whole nation and for individual men.

c. Evil development within the scribal office.

It lies in the nature of every law system like the law of Moses that it raises questions which it does not solve. The Jewish teacher could recognize no principles beyond the precepts of the Law. The result showed that, in this as in other instances, the idolatry of the letter was destructive of the very reverence in which it had originated. Decisions on fresh questions were accumulated into a complex system of casuistry. The new precepts, still transmitted orally, came practically to take their place. The "Words of the Scribes," now used as a technical phrase for these decisions, were honored above the Law. It was a greater crime to offend against them than against the Law. They were as wine, while the precepts of the Law were as water. The first step was taken toward annulling the commandments of God for the sake of their own traditions. The casuistry became at once subtle and evil, evading the plainest duties, tampering with conscience.⁴ The right relation of moral and ceremonial laws was not only forgotten, but absolutely inverted. This was the result of the profound reverence for the letter which gave no heed to the "word abiding in them."⁵

The teaching of the Scribes about an Oral Law was naturally opposed to the opinions of the Sadducees. The

3. Neh. 17:13.

4. Matt. 15:1-6; 23:16-23.

5. John 5:38. Their teaching is contained in the Talmud.

leading tenet of the Sadducees tended, by maintaining the sufficiency of the letter of the Law, to destroy the very occupation of a Scribe; and the class, as such, belonged to the party of the Pharisees.

d. *The schools of Hillel and Shammai.*

There were within the party of the Pharisees, within the order of the Scribes, two schools with distinctly opposed tendencies, one vehemently, rigidly orthodox, the other orthodox also, but with an orthodoxy which, in the language of modern politics, might be classed as Liberal Conservative. The latter party was founded by Hillel (born about 112 B.C.), while the strictly orthodox party was represented by his contemporary, Shammai. The two were held in nearly equal honor. One, in Jewish language, was the Nasi, the other the Ab-beth-din of the Sanhedrin. They did not teach, however, as their predecessors had done, in entire harmony with each other. The points on which they differed were almost innumerable. In most of them, questions as to the causes and degrees of uncleanness, as to the law of contracts or of wills, we can find little or no interest. On the former class of subjects the school of Shammai represented the extremest development of the Pharisaic spirit. The teaching of Hillel showed some capacity for wider thoughts. He was the first to lay down principles for an equitable construction of the Law with a dialectic precision which seems almost to imply a Greek culture. The genial character of the man comes out in some of his sayings, which remind us of the tone of Jesus the son of Sirach, and present some faint approximations to a higher teaching. The contrast showed itself in the conduct of the followers not less than in the teachers. The disciples of Shammai were conspicuous for their fierceness, appealed to popular passions, and used the sword to decide their controversies. Out of that school grew the

party of the Zealots, fierce, fanatical, vindictive, the Orangen-men of Pharisaism. Those of Hillel were like their master, cautious, gentle, tolerant, unwilling to make enemies, content to let things take their course. One sought to impose upon the proselyte from heathenism the full burden of the Law, the other that he should be treated with some sympathy and indulgence. The teaching of our Lord must have appeared to men different in many ways from both. While the Scribes repeated the traditions of the elders, He "spake as one having authority," "not as the Scribes."⁶ While they confined their teaching to the class of scholars, He "had compassion on the multitudes."⁷ While they were to be found only in the council or in their schools, He journeyed through the cities and villages.⁸ While they spoke of the kingdom of God vaguely, as a thing far off, He proclaimed that it had already come nigh to men.⁹ But in most of the points at issue between the two parties, He must have appeared in direct antagonism to the school of Shammai, in sympathy with that of Hillel.

On the other hand, because the temper of the Hillel school was one of mere adaptation to the feeling of the people, cleaving to tradition, wanting in the intuition of a higher life, the teaching of Christ must have been felt as unsparingly condemning it. It adds to the interest of this inquiry to remember that Hillel himself lived, according to the tradition of the Rabbis, to the great age of 120, and may therefore have been present among the doctors of Luke ii. 46. Gamaliel, his grandson and successor,¹⁰ was at the head of this school during the whole of the ministry of Christ, as well as in the early portion of the history of the Acts. We are thus able to explain the fact, which so many

6. Matt. 7:29.

7. Matt. 9:36.

8. Matt. 4:23; 9:35; et al.

9. Matt. 4:17.

10. Rabbi Simeon, the father of Gamaliel, came between them, but apparently for a short time only.

passages in the Gospels lead us to infer,—the existence all along of a party among the Scribes themselves, more or less disposed to recognize Jesus of Nazareth as a teacher,¹¹ not far from the kingdom of God,¹² advocates of a policy of toleration;¹³ but, on the other hand, timid and time-serving, unable to confess even their half-belief,¹⁴ afraid to take their stand against the strange alliance of extremes which brought together the Sadducean section of the priesthood and the ultra-Pharisaic party. When the last great crisis came, they apparently contented themselves with a policy of absence.¹⁵

*e. Training for and advancement within
the Scribe's office.*

The special training for a Scribe's office began, probably, about the age of thirteen. The boy who was destined by his parents to the calling of a Scribe went to Jerusalem, and applied for admission to the school of some famous Rabbi. The master and his scholars met; the former sitting on a high chair, the elder pupils on a lower bench, the younger on the ground, both literally "at his feet." The education was chiefly catechetical, the pupil submitting cases and questions, the teacher examining the pupil.¹⁶ After a sufficient period of training, probably at the age of thirty, the probationer was solemnly admitted to his office.

There still remained for the disciple, after his admission, the choice of a variety of functions, the chances of failure and success. He might give himself to any one of the branches of study, or combine two or more of them. He might rise to high places, become a doctor of the law,

11. John 8:1; Mk. 10:17.

12. Mk. 12:34.

13. John 7:51.

14. John 12:42.

15. Luke 18:50-51.

16. Luke 2:46.

an arbitrator in family litigations,¹⁷ the head of a school, a member of the Sanhedrin. He might have to content himself with the humbler work of a transcriber, copying the Law and the Prophets for the use of synagogues, or a notary writing out contracts of sale, covenants of espousals, bills of repudiation. The position of the more fortunate was of course attractive enough. In our Lord's time the passion for distinction was insatiable. The ascending scale of Rab, Rabbi, Rabban, presented so many steps on the ladder of ambition. Other forms of worldliness were not far off. The salutations in the market-place,¹⁸ the reverential kiss offered by the scholars to their master, or by Rabbis to each other, the greeting of Abba, father,¹⁹ the long robes with the broad, blue fringe (Matt. xxiii. 5), all these go to make up the picture of a Scribe's life. Drawing to themselves, as they did, nearly all the energy and thought of Judaism, the close hereditary caste of the priesthood was powerless to compete with them. Unless the priest became a Scribe also, he remained in obscurity. The order, as such, became contemptible and base. For the Scribes there were the best places at feasts, the chief seats in synagogues.²⁰

(For questions about the Scribes, see numbers 83-91, page 889.)

G. THE SANHEDRIN.

The word *Sanhedrin* is formed from the Greek *Sunedrion* which means "a sitting together." The *Great Sanhedrin*, as it is called in the Talmud, was the supreme council of the Jewish people in the time of Christ and earlier. In the Mishna it is also styled *house of judgment*.

17. Luke 12:14.

18. Matt. 23:7.

19. Matt. 23:9.

20. Matt. 23:6; Luke 14:7.

JEWISH SANHEDRIN

The *origin* of this assembly is traced in the Mishna to the seventy elders whom Moses was directed to associate with him in the government of the Israelites (Num. xi. 16, 17). This body continued to exist, according to the Rabbinical accounts, down to the close of the Jewish commonwealth. But it is now generally admitted that the tribunal established by Moses was probably temporary, and did not continue to exist after the Israelites had entered Palestine.

The fact that Herod, when procurator of Galilee, was summoned before the Sanhedrin (B.C. 47), on the ground that in putting men to death he had usurped the authority of the body (Joseph. *Ant.* xiv. 9, 4), shows that it then possessed much power and was not of very recent origin. It probably originated shortly after the Babylonian captivity.

In the silence of Philo, Josephus, and the Mishna respecting the *constitution* of the Sanhedrin, we are obliged to depend upon the few incidental notices in the New Testament. From these we gather that it consisted of *chief priests*, or the heads of the twenty four classes into which the priests were divided (including, probably, those who had been high-priests); *elders*, men of age and experience; and *scribes*, lawyers, or those learned in the Jewish law (Matt. xx. 57, 59; Mark xv. 1; Luke xxii. 66; Acts v. 21).

The number of members is usually given as 71, though other authorities make them 70, and others 72. The president of this body was styled *Nasi*, and was chosen on account of his eminence in worth and wisdom. Often, if not generally, this pre-eminence was accorded to the high-priest. That the high-priest presided at the condemnation of Jesus (Matt. xxvi. 62) is plain from the narrative.

As a judicial body the Sanhedrin constituted a supreme court, to which belonged in the first instance the trial of a tribe fallen into idolatry, false prophets, and the high-priest, as well as the other priests. As an admin-

istrative council, it determined other important matters. Jesus was arraigned before his body as a false prophet (John xi. 47), and Peter, John, Stephen, and Paul as teachers of error and deceivers of the people. From Acts ix. 2, it appears that the Sanhedrin exercised a degree of authority beyond the limits of Palestine. According to the Jerusalem Gemara, the power of inflicting capital punishment was taken away from this tribunal forty years before the destruction of Jerusalem. With this agrees the answer of the Jews to Pilate (John xix. 31), "It is not lawful for us to put any man to death." Beyond the arrest, trial, and condemnation of one convicted of violating the ecclesiastical law, the jurisdiction of the Sanhedrin at the time could not be extended; the confirmation and execution of the sentence in capital cases belonged to the Roman procurator. The stoning of Stephen (Acts vii. 56 sqq.) is only an apparent exception, for it was either a tumultuous procedure, or, if done by order of the Sanhedrin, was an illegal assumption of power, as Josephus (*Ant.* xx. 9, 1) expressly declares the execution of the Apostle James during the absence of the procurator to have been.

(For questions about the Sanhedrin, see numbers 92-98, page 889-890.)

SELECTED BIBLIOGRAPHY FOR ARTICLE:
 THE CHRISTIAN AND EVOLUTION,
 AND OTHER SELECTED STUDIES

- Blum, Harold F. *Time's Arrow and Evolution*. Princeton, N.J.: Princeton University Press, 1968.
- Berkhof, L. *Principles of Biblical Interpretation*. Grand Rapids, Mich.: Baker Book House, (c) 1950.
- Burnett, R. Will, and Fisher, Harvey I.,-and Zim, Herbert S. *Zoology, An Introduction to the Animal Kingdom*. New York, N.Y.: Golden Press, 1958.
- Clark, Harold W. *The Wonders of Creation*. Mountain View, Ca.: Pacific Press Publishing Assn., 1964.
- Clark, Robert E. D. *Darwin, Before and After*. Exeter, Great Britain: Paternoster Press, 1966.
- *The Universe: Plan or Accident*. Philadelphia, Pa.: Fortress Press (Muhlenberg Press), 1961.
- Crawford, C. C. *Genesis, Vol. I*. Joplin, Mo.: College Press, 1966.
- Dewar, Douglas. *The Transformist Illusion*. Murfreesboro, Tenn.: DeHoff, 1957.
- Enoch, H. *Evolution or Creation*. London, England: Evangelical Press and Service Ltd. (American agents: Puritan Publications, Inc.), 1966.
- Geisler, Norman L. and Nix, William E. *A General Introduction to the Bible*. Chicago, Ill.: Moody Press, 1968.
- Greek New Testament*. New York, N.Y.: American Bible Society, 1965.
- Huxley, Julian. *Evolution in Action*. New York, N.Y.: New American Library (Signet), 1953.
- Kenyon, Sir Frederic G. *Handbook to the Textual Criticism of the New Testament*. Grand Rapids, Mich.: Wm. B. Eerdmans Publishing Company.
- Kerkut, G. A. *Implications of Evolution*. Elmsford, N.Y.: Pergamon Press Ltd., 1960 (used with permission of the author).
- Klotz, John W. *Genes, Genesis and Evolution*. St. Louis, Mo.: Concordia Publishing House, 1955.
- Matthews III, William H. *Geology Made Simple*. New York, N.Y.: Doubleday, 1967.
- McGarvey, J. W. *The Fourfold Gospel*. Cincinnati, Ohio: Standard Publishing, 1914.
- Mickelsen, A. Berkeley. *Interpreting the Bible*. Grand Rapids, Mich.: Wm. B. Eerdmans Publishing Company, (c) 1963.
- Monsoma, John Clover, Ed. *The Evidence of God in an Expanding Universe*. New York, N.Y.: Putnam Press, 1958.
- Morris, Henry M. *Evolution and the Modern Christian*. Grand Rapids, Mich.: Baker Book House, 1967.
- *Studies in the Bible and Science*. Grand Rapids, Mich.: Baker Book House, 1966.
- *The Bible and Modern Science*. Chicago, Ill.: Moody Press, 1951.
- and Whitcomb, John C. *The Genesis Flood*. Grand Rapids, Mich.: Baker Book House, 1961.

BIBLIOGRAPHY FOR SELECTED STUDIES

- Nelson, Byron C. *After Its Kind*. Minneapolis, Minn.: Bethany Fellowship, 1967.
- New American Standard Bible*. LaHabra, Ca.: The Lockman Foundation, 1971.
- Revised Standard Version*. New York, N.Y.: National Council of Churches, 1962.
- Rimmer, Harry. *The Theory of Evolution and the Facts of Science*. Grand Rapids, Mich.: Wm. B. Eerdmans Publishing Company, 1935.
- Schaeffer, Francis A. *The God Who Is There*. Downers Grove, Ill.: Inter-Varsity Press, 1968.
- Shapley, Harlow S., Ed. *Science Ponders Religion*. New York, N.Y.: Appleton-Century-Crofts, 1960.
- Thomas, J. D. *Facts and Faith*. Abilene, Tx.: Biblical Research Press, 1965.
- Tinkle, William J. *Heredity, A Study in Science and the Bible*. Houston, Tx.: St. Thomas Press.
- Ward, Rita Rhodes, *In the Beginning*. New York, N.Y.: Sentinel Publishing Company (previously printed by Baker Book House), 1965.
- Wilder-Smith, H. E. *Man's Origin, Man's Destiny*. Wheaton, Ill.: Harold Shaw Publishers, 1968.

TRACTS

- Custance, Arthur C. *The Fallacy of Anthropological Reconstructions*. Ottawa, Canada: Doorway Papers, 1966.
- Evolution, Science Falsely So-Called*. Toronto, Canada: International Christian Crusade, 1936.
- Hand, John Raymond. *Why I Accept the Genesis Record*. Lincoln, Neb.: Back to the Bible, 1959.

PERIODICALS

- Creation Research Society*, 1965 January Quarterly, W. Lammerts, Ed., "Problems in Absolute Age Determination" by D. O. Acrey, pp. 7-9.
- 1966 January Quarterly, W. Lammerts, Ed., "Address before the Texas Textbook Committee" by Douglas Dean, pp. 9-12.
- 1966 January Quarterly, W. Lammerts, Ed., "How Reliable is Carbon-14 Dating" by Harry Wiant, Jr., p. 31.
- 1968 September Quarterly, W. Lammerts, Ed., "Radio Carbon Confirms Biblical Creation" by Robert Whitelaw, pp. 78-83.
- 1968 December Quarterly, W. Lammerts, Ed., "William J. Meister Discovery of Human Footprint with Trilobites in a Cambrian Formation of Western Utah" by Melvin Cook, p. 97.
- 1969 Annual, G. F. Howe, Ed., "The Form and Structure of Living Things" by Frank R. Marsh, pp. 13-25.
- 1969 Annual, G. F. Howe, Ed., "Ontogeny Recapitulates Phylogeny" by Wilbert H. Rusch, Sr., pp. 27-34.

BIBLIOGRAPHY FOR SELECTED STUDIES

- Bible-Science Newsletter*, Walter Lang, Ed., "Looking at the Evidence" by John W. Klotz.
- "Satan's Modern Trap and God's Creation" by William Overn.
- 1969 September Quarterly, G. F. Howe, Ed., "Creationistic Botany Today: A Progress Report" by George F. Howe, pp. 85-95.
- Reader's Digest*, April 1960, "The Riddle of the Quick Frozen Mammoths" by Ivan T. Sanderson.
- January 1964, "Earliest Man on Earth?" by Francis and Katharine Drake.
- Plain Truth, The*, November 1969, "Evolution Gets the Horse Laugh" by Paul Kroll.

SUGGESTED ADDITIONAL BIBLIOGRAPHY

- Baxter, Batsell Barrett. *I Believe Because*. Grand Rapids, Mich.: Baker Book House, 1971.
- Biology, A Search for Order in Complexity*. Grand Rapids, Mich.: Zondervan Publishing House, C.R.S. Society (a really fine book for teachers!!)
- Rehwinkel, Alfred M. *The Flood*, St. Louis, Mo.: Concordia Publishing House, 1957.
- Schaeffer, Francis A. *Escape from Reason*. Downers Grove, Ill.: InterVarsity Press, 1968.